

50
YEARS

1967-2017

THANK YOU!

50 YEARS

1967 - 2017

BIENVENIDOS - WELCOME - BIENVENUE

ESP Bienvenidos a este recorrido por los 50 años de historia de Planning Sisplamo a través del nuevo catálogo de productos. Un catálogo reestructurado, ordenado y sobretodo útil. Tu herramienta de trabajo, otro año más a tu disposición.

ENG Welcome to this journey through the new product catalogue of the 50 years of history of Planning Sisplamo. Restructured, ordered and above all useful. Your work tool, another year at your disposal.

FRA Bienvenue sur le parcours des 50 ans d'histoire de Planning Sisplamo au travers de ce nouveau catalogue de produits. Un catalogue restructuré, re-ordonné, et surtout utile. Votre outil de travail une nouvelle fois à votre disposition.

SISPLAMO

N 41° 23' 57,983"
E 2° 10' 29,35"
BARCELONA



1967

1970

1976

ESP Fundada en Barcelona la empresa SISPLAMO, que se encarga de la fabricación de sistemas de planificación móviles, de la mano de Ramón Circuns.

ENG SISPLAMO was founded in Barcelona, to manufacture mobile planning systems, by Ramón Circuns.

FRA Création de la société Planning Sisplamo par Ramón Circuns, en charge de la fabrication de systèmes de planification mobiles.

ESP Tras 3 años fabricando plannings en el Pg. Napoléon, nos trasladamos a la C/ Aragón, nº414, en el centro de Barcelona.

ENG After 3 years manufacturing plannings in Pg. Napoléon, we moved to C/ Aragón, nº414, in the center of Barcelona.

FRA Après 3 années de fabrication de plans sur le passage Napoléon, nous déménageons dans le centre de Barcelone, rue Aragón nº414.

ESP Diseño del primer catálogo. 12 páginas en blanco y negro donde se ofrecen plannings, pizarras murales y de caballete, tableros de anuncios, mapas y otras soluciones visuales.

ENG Design of the first brochure made of 12 black-and-white pages featuring planning wall-mounted boards, easel boards, bulletin boards, maps and other visual solutions.

FRA Création du premier catalogue. 12 pages en noir et blanc offrant plannings, tableaux muraux et chevalets, tableaux d'annonces, plans et autres solutions visuelles.

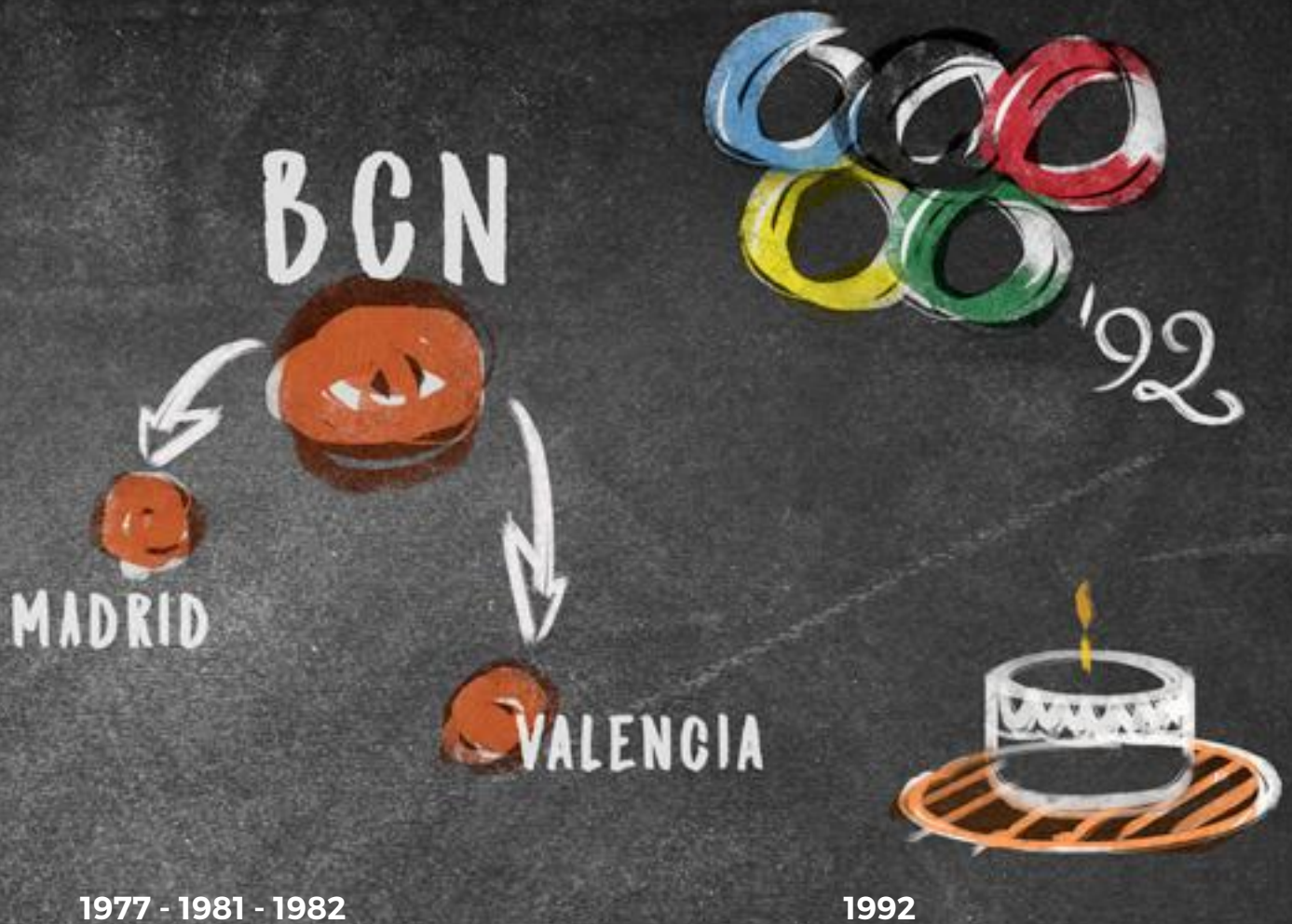

ESP Primera participación en diferentes ferias del sector del diseño: la Fira Internacional de Barcelona con un stand de 16 m², la SIMO en Madrid y la DIPA en Valencia.

ENG Participation in design fairs for the first time, including the Fira Internacional de Barcelona with a 16 m² stand, the SIMO fair in Madrid and DIPA fair in Valencia.

FRA Première participation aux différentes foires du secteur design: La foire internationale de Barcelone avec un stand de 16 m², la SIMO à Madrid, et la DIPA à Valence.

ESP El 25 aniversario de Planning Sisplamo coincide con la celebración de los JJOO de Barcelona '92. PS equipa al Comité Olímpico Organizador de Barcelona con pizarras y tableros. Ese mismo año se publica el catálogo de Planning que marcará un antes y un después en el sector, tanto por estilo como por variedad de productos.

ENG The Planning Sisplamo 25th anniversary in 1992 coincides with the Summer Olympic Games in Barcelona. PS equips the Olympic Organizing Committee of Barcelona with notice boards and whiteboards. That same year, a Planning Sisplamo brochure is published, which marks a before and after in the sector, both in style and variety of products.

FRA Le 25ème anniversaire de Planning Sisplamo coïncide avec la célébration des Jeux Olympiques de Barcelone en 92. Planning équipe le comité olympique de tableaux et panneaux d'affichage. Cette même année, se publie le catalogue de Planning qui marquera un avant et après dans le secteur, tant pour son style que pour sa variété de produits.

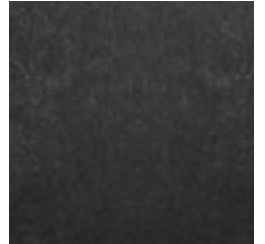
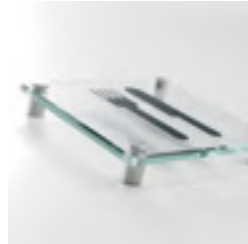
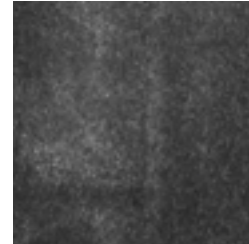
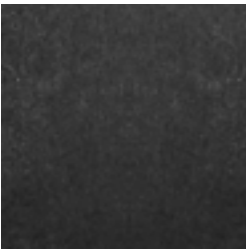

PS PRODUCTS

01	VISUALPLAN	PAG. 06 - 53
02	ESCOLPLAN	PAG. 54 - 79
03	INFORMPLAN	PAG. 80 - 105
04	EXPOPLAN	PAG. 106 - 149
05	MODULPLAN	PAG. 150 - 183
06	ROTULPLAN	PAG. 184 - 217
07	PROYECPLAN	PAG. 218 - 233



01

VISUALPLAN

COMUNICACIÓN VISUAL
VISUAL COMMUNICATION
COMMUNICATION VISUELLE



SUPERFICIES PS

SUPERFICIES DE ESCRITURA
WRITTING SURFACES
SURFACE D'ÉCRITURE

ESP Descripción, características y cualificación según calidad de las diferentes superficies de escritura en los productos Visualplan. Incluye características de una pared cubierta con pintura de pizarra, superficie de vidrio o superficie blanca en diferentes materiales.

ENG Description, characteristics and uses according to the quality of the writing surface in the Visualplan product range. Includes features such as wall covered slate paint, glass surfaces or white surfaces in different materials and colors.

FRA Peinture murale pour convertir n'importe quelle superficie en tableau. Fonctionne avec feutre effaçable à sec. Disponible en couleur blanche ou transparente.

01

PINTURA PS
PS PAINT
PEINTURE PS

PNT



02

SUPERFICIE DE CRISTAL
GLASS SURFACE
TABLEAU EN VERRE

728/CC - 728 - 728/M



03

SUPERFICIE LACADA
LACQUERED SURFACE
SURFACE LAQUÉE

BL/VI - 722 - 724/LC - 1000 - LEAN



CAPA DE PINTURA

ESP Pintura de pared para convertir cualquier superficie en una pizarra. Rotulable con rotuladores de borrado en seco. Disponible en color blanco o transparente.

ENG Wall paint to turn any surface into a board. Can be marked with erasers in dry conditions. Available in white and clear.

FRA Peinture murale pour convertir n'importe quelle superficie en tableau. Fonctionne avec feutre effaçable à sec. Disponible en couleur blanche ou transparente.



SUPERFICIE DE CRISTAL

ESP Cristal pintado en blanco de 4 mm de grosor, unido con una chapa de 0,8 mm de hierro galvanizado magnética. Fácil mantenimiento y borrado gracias a la baja porosidad del material. Resistente a la abrasión, productos químicos, fuego, bacterias y grafitis.

ENG Glass painted in white 4 mm thick with a 0.8 mm sheet of galvanized iron. Magnetic. Easy maintenance and erasure because of the low porosity of the material. Resistant to graze, chemicals, fire, bacteria and graffiti.

FRA Verre peint en blanc de 4 mm d'épaisseur uni à une tôle en fer galvanisé de 0,8mm. Magnétique, Facile d'entretien grâce à une faible superficie poreuse, Résistante à l'abrasion, produits chimiques, feu, bactéries et graffitis.



SUPERFICIE LACADA

ESP Superficie blanca magnética de chapa metálica lacada cocida a más de 100°C. Incluye chapa de aluminio para mayor resistencia. Fácil mantenimiento.

ENG Magnetic white surface of lacquered metal sheet heated to more than 100°C. Includes aluminum foil for added strength. Easy maintenance.

FRA Superficie blanche magnétique grâce à une tôle métallique laquée cuite à plus de 100°C. Inclus renfort en aluminium pour une plus grande résistance. Facile d'entretien.



PERFILES Y CANTONERAS PROFILES AND ANGLES PROFILÉS ET COINS

ESP Los perfiles que enmarcan las pizarras de Planning Sisplamo son de aluminio anodizado. Las cantoneras, que ocultan el tornillo, son piezas fabricadas por inyección de ABS.

ENG The profiles framing Planning Sisplamo white boards are anodized aluminum. The corners, which conceal the screw, are manufactured by injection ABS.

FRA Les profiles qui encadrent les tableaux Planning Sisplamo sont en aluminum anodisé. Les coins, qui cachent la fixation, sont des pièces fabriquées par injection d'ABS.

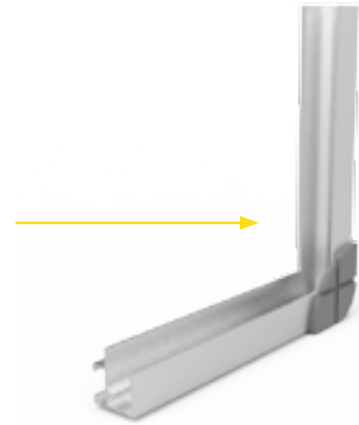

04 SUPERFICIES LAMINADA LAMINATED SURFACE SURFACE STRATIFIÉE

725 - 725/X



05 ACERO VITRIFICADO ENAMELLED SURFACE SURFACE ÉMAILLÉE

720 - 720/C - 720/P - 724 - ZENIT - 729 - 720/D 720/T - 720/X - 720/VV - 720/G W/720 - LEAN



CeramicSteel

La superficie e³ CeramicSteel es la única del sector a nivel mundial con la certificación:

Cradle to Cradle Certified™ Bronze

Norma ISO 9001



SUPERFICIE LAMINADA



ESP Superficie de escritura blanca en plancha laminada de alta presión (HPL). Extremadamente resistente a los impactos y desgaste. Fácil mantenimiento. No magnética.

ENG White writing surface in high pressure laminated board (HPL). Extremely resistant to impacts and usage. Easy maintenance. Not magnetic.

FRA Superficie d'écriture blanche en planche laminée à haute pression (HPL). Extrêmement résistante aux impacts et usure. Facile d'entretien. Non magnétique.



ACERO VITRIFICADO



ESP Superficie blanca en acero vitrificado formada por una lámina central de acero de 0,7 mm cubierta con un revestimiento delgado de esmalte, que se funde con el acero a 800°C. Fabricado con un 30% de acero reciclado. Reciclable al 99,9%. Se puede escribir con marcadores de borrado en seco, semipermanentes, solubles al agua o permanentes sin dañarla. Garantía de por vida. Resistente a rayaduras, abrasión, productos químicos, fuego, bacterias y grafitis. Fácil mantenimiento. Mayor contraste de color. Visibilidad mejorada y óptima comodidad visual. Magnética.

ENG White surface in vitrified steel formed by a 0.7 mm steel core sheet covered with a thin coating of enamel, which melts with the steel at 800 ° C. Made with 30% recycled steel. Recyclable at 99.9%. It can be written on with dry erase markers, semipermanent, water soluble or permeant without damaging it. Lifetime warranty. Resistant to scratches, abrasion, chemicals, fire, bacteria and graffiti. Easy maintenance. Higher color contrast. Improved visibility and optimum visual comfort. Magnetic.

FRA Superficie blanche en acier vitrifié formé par une tôle d'acier de 0,7mm recouverte d'un revêtement émaillé fondu à 800°C. Fabriqué avec 30% d'acier recyclé. Recyclable à 99,9%. Peuvent s'utiliser des marqueurs effaçable à sec, semi-permanent, d'eau, ou permanents sans l'abîmer. Garantie à vie. Résistant aux rayures, abrasion, produits chimiques, feu, bactéries et graffitis. Facile d'entretien. Grand contraste de couleur. Visibilité améliorée et qualité visuelle optimum. Magnétique.



GUÍA PS

ESCOGE TU **PIZARRA**
CHOOSE YOUR **WHITEBOARD**
CHOISIR VOTRE **TABLEAU**

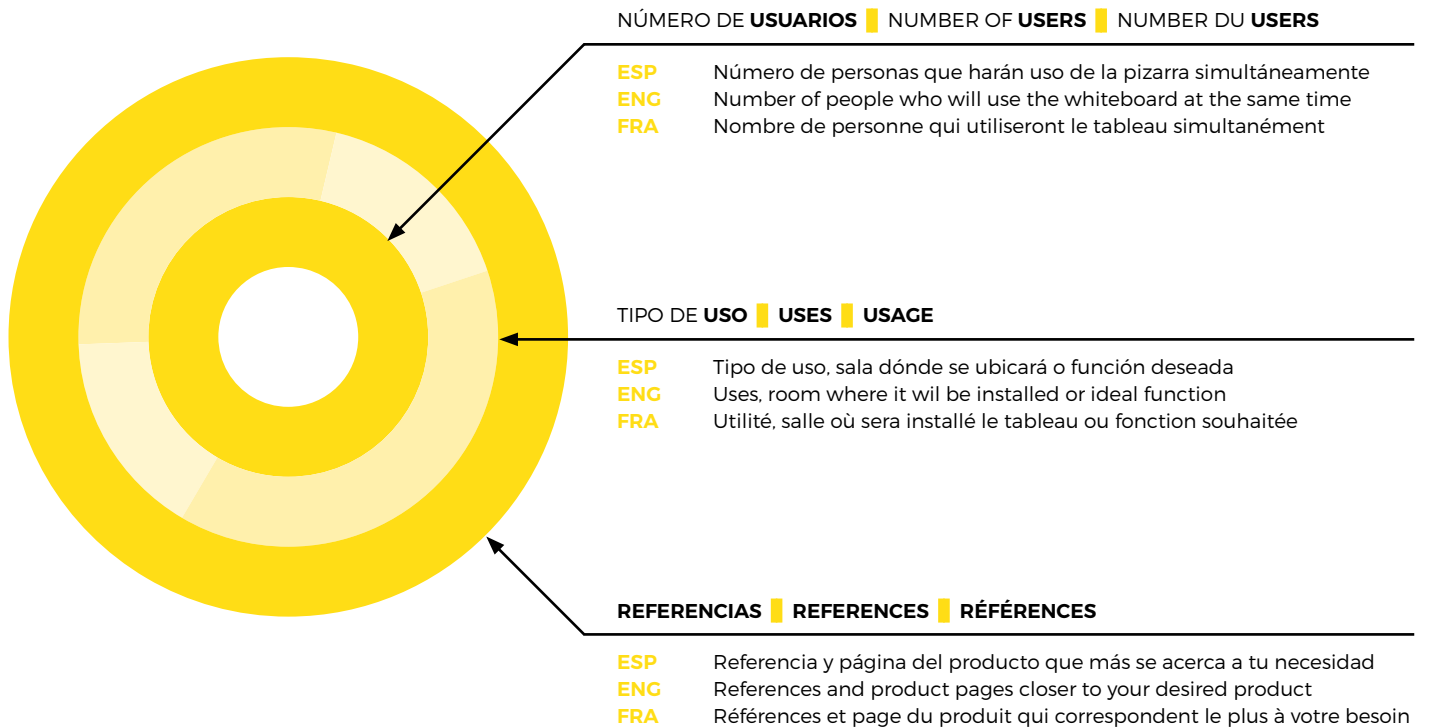

PERSONAL

PERSONAL | PERSONALE

ESP Pizarras de uso personal para el uso en el hogar o en salas de pequeñas dimensiones. Disponibles en versión mural, con soportes, y en diferentes materiales.
MMR: 40 x 60 cm.

ENG Whiteboards for personal use for use at home or in small rooms. Available in wall version, with supports, and different materials.
MMR: 40 x 60 cm.

FRA Tableau à usage personnel pour la maison ou de petites pièces/bureaux. Disponible en version murale, avec support et en différents matériaux.
MMR: 40 x 60 cm

BUSINESS

BUSINESS | NEGOTIATIONS

ESP Pizarras para uso en salas de reuniones o aulas de estudiantes reducidas. Disponibles en versión mural, con soporte y en diferentes materiales.
MMR: 100 x 120 cm.

ENG Whiteboards for use in meeting rooms or small classrooms. Available wall version, with supports, and in different materials.
MMR: 100 x 120 cm.

FRA Tableaux pour usage en salles de réunions et petites salles de classe. Disponibles en version murale, avec supports et en différents matériaux.
MMR: 120 x 200 cm

ESCUELA

SCHOOL | ÉCOLE

ESP Pizarras para el uso en aulas de mayor dimensión para más estudiantes. Disponibles en versión mural y en diferentes materiales.
MMR: 120 x 250 cm.

ENG Whiteboards for use in larger classrooms for more students. Available mural version and different materials.
MMR: 120 x 250 cm.

FRA Tableaux pour usage en salle de grande dimension pour plus d'étudiants. Disponible en version murale et en différents matériaux.
MMR: 120 x 250 cm.

*MMR

Medida Mínima Recomendada ■ Recommended Minimum Size ■ Dimension Minimum Recommandée

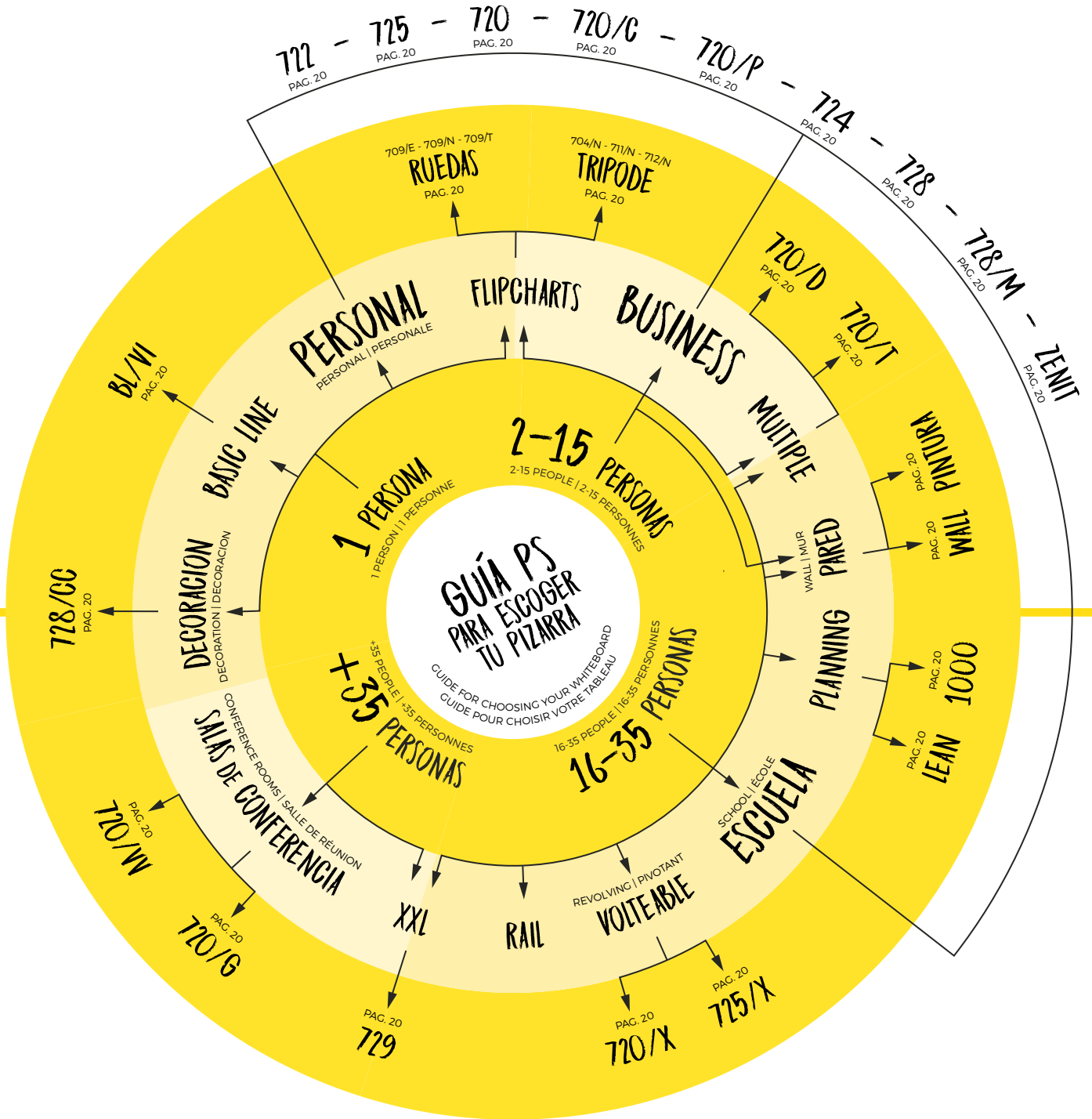

* 720 - 725 - 720 - 720/C - 720/P - 724 - 728 - 728/M - ZENIT

Diferentes medidas según uso o ubicación. Diferentes sizes for different uses or locations. Différentes mesures selon usage et emplacement.



1.

ESP Selecciona el perfil en el cual clasificarás tu captura.

ENG Select the profile in which you will classify your.

FRA Sélectionnez le profil dans lequel vous organiserez vos captures.



2.

ESP Encaja el contenido de la pizarra a la pantalla de tu smartphone. Espera a que dispare o dispara tú mismo.

ENG Embed the content of the whiteboard to the screen of your smartphone. Wait for automatic image or take picture yourself.

FRA Réajustez le contenu du tableau à l'écran de votre smartphone. Attendez la capture automatique ou faites-le manuellement.



3.

ESP Clasifica la imagen por etiquetas según asignaturas o temas.

ENG Sort the image using tags according to subjects.

FRA Ordonnez vos images par étiquettes suivant la matière ou le thème.



4.

ESP Comparte tus notas, apuntes o fotos con quien quieras a través mail, whatsapp u otras aplicaciones.

ENG Share your notes or photos with whoever you want via mail, whatsapp or other applications.

FRA Partagez vos notes, vos croquis ou photos avec qui vous le souhaitez par email, sms ou autres app.

planningsisplamo.com/pscapture

PS capture

by Planning Sisplamo



Capta, clasifica y comparte el contenido de tu pizarra.
Capture, classify and share the content of your board.
Capturez, ordonnez et partagez le contenu de votre tableau.





BASIC

PIZARRA **LACADA**
LACQUERED WHITEBOARD
 TABLEAU **LAQUÉ**



REF	L	H	W
BL/VI/0010	45 x 60	1	30
BL/VI/0011	60 x 90	1	30
BL/VI/0012	90 x 120	1	30
BL/VI/0013	100 x 150	1	30
BL/VI/0014	100 x 200	1	30

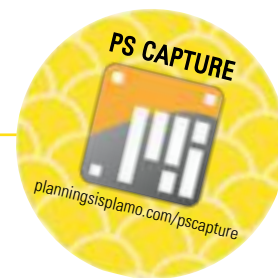
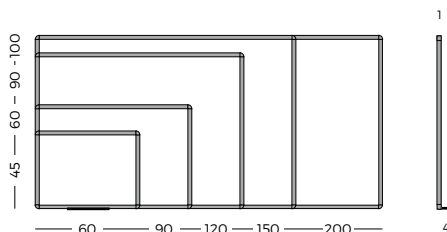

PIZARRA BLANCA BASIC

ESP Pizarra mural blanca enmarcada con perfil de aluminio anodizado en color plata mate y cantoneras redondeadas de plástico gris. Superficie lacada y magnética rotulable en seco. Incluye cajetín reposarrotuladores de 30 cm.

BASIC WHITEBOARD

ENG Whiteboard equipped with silver anodised aluminium frame and grey plastic rounded corners. Surface is laminated and suitable for writing with dry wipe board markers. A 30 cm. pen tray included.

TABLEAU BLANC BASIC

FRA Tableau blanc stratifié avec encadrement en aluminium anodisé couleur argent aux coins arrondis en plastique gris. Surface mélaminée effaçable à sec. Livré avec un auget porte marqueurs de 30 cm.



VISUALPLAN

PIZARRA CRISTAL GLASS BOARD TABLEAU EN VERRE 728/CC

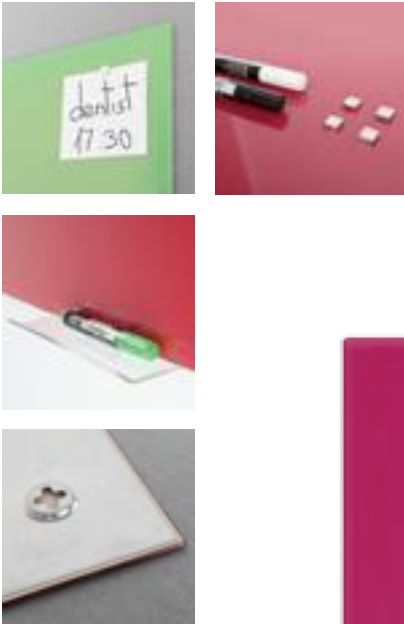

COLOR CRISTAL



REF	L	H
728/CC/1	45 x 45	1.5

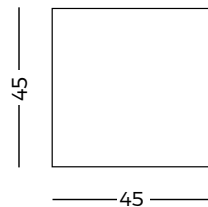

REF	+	DESC.
7280	20	Bandeja 20 cm. Tray 20 cm. Porte marqueurs 20 cm.

PIZARRA CRISTAL

ESP Pizarra cuadrada de vidrio magnética, de diseño sencillo y colores intensos. Superficie de escritura rotulable en seco. Sistema de montaje no visible. Disponible bandeja de acrílico.

GLASSBOARD

ENG Glass magnetic whiteboard with a simple design and beautiful colors. Suitable for writing with dry wipe board markers. Easy and hidden hanging system. Clear plastic tray available.

TABLEAU EN VERRE

FRA Tableau en verre magnétique, design simple et couleurs intense. Surface pour feutre effaçable à sec. Système de montage invisible. Disponible auget ou kit d'accessoires.



722

PIZARRA LACADA
LACQUERED WHITEBOARD
TABLEAU LACQUÉ



REF	L	H	RAIL	RAIL
722/1	45 x 60	2.2	30	-
722/2	60 x 90	2.2	30	✓
722/3	90 x 120	2.2	30	✓
722/5	100 x 150	2.2	30	✓
722/6	100 x 200	2.2	30	-
722/7	100 x 250	2.2	30	-
722/8	100 x 300	2.2	30	-

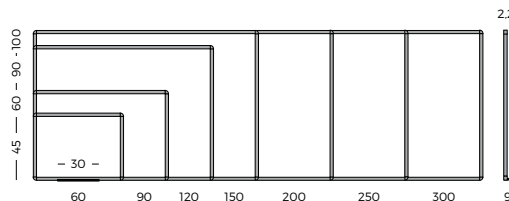

PIZARRA BLANCA LACADA

ESP Pizarra mural blanca enmarcada con perfil de aluminio anodizado en color plata mate y cantoneras redondeadas de plástico negro. Superficie magnética lacada rotulable en seco. Incluye cajetín reposarrotuladores de 30 cm.

LACQUERED WHITEBOARD

ENG Whiteboard equipped with silver anodised aluminium frame and black plastic rounded corners. Magnetic attachable, lacquered surface suitable for writing with dry wipe board markers. A 30 cm. pen tray included.

TABLEAU LAQUÉ

FRA Tableau blanc lacqué avec encadrement en aluminium anodisé couleur argent aux coins arrondis en plastique noir. Surface laquée magnétique effaçable à sec. Livré avec auget porte marqueurs 30 cm.



SOPORTE T

REF	↓	L	HT	□
722/3 + 770/1	190	90 x 120	53	30
722/5 + 770/1	190	100 x 150	53	30
722/6 + 770/1	190	100 x 200	53	30



SOPORTE DELTA

REF	↓	L	HT	□
722/3 + 770/2	190	90 x 120	53	30
722/5 + 770/2	190	100 x 150	53	30
722/6 + 770/2	190	100 x 200	53	30



SOPORTE Y2

REF	↓	L	HT	□
722/3 + Y2/120	173	90 x 120	53	30
722/5 + Y2/150	173	100 x 150	53	30
722/6 + Y2/200	173	100 x 200	53	30

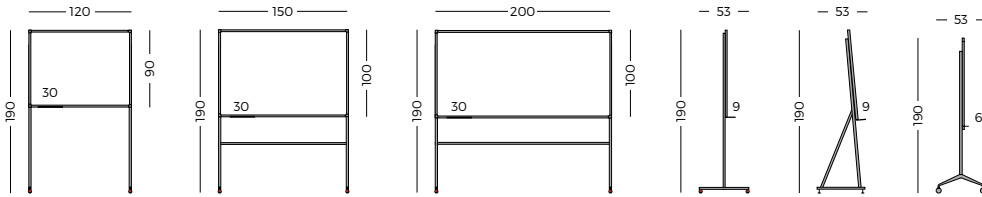

PS CAPTURE

App by Planning Sisplamo
planningsisplamo.com/pscapture



ACCESORIOS

REF: 7006

REF: 7014

REF: 7005

REF: 7008





725

PIZARRA LAMINADA
LAMINATED WHITEBOARD
TABLEAU STRATIFIÉ



REF	L	H	RAIL	RAIL
725/1	40 x 60	2.2	30	-
725/2	60 x 80	2.2	30	-
725/3	80 x 120	2.2	30	✓
725/4	100 x 120	2.2	30	✓
725/5	120 x 150	2.2	30	✓
725/6	120 x 175	2.2	30	✓
725/7	120 x 200	2.2	30	-
725/8	120 x 250	2.2	30	-
725/9	120 x 300	2.2	30	-

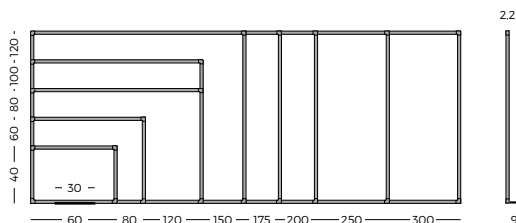

REF	L	H	RAIL	RAIL
725/5/M	120 x 150	2.2	30	✓
725/7/M	120 x 200	2.2	30	-
725/8/M	120 x 250	2.2	30	-



PIZARRA LAMINADA

ESP Pizarra mural blanca enmarcada con perfil de aluminio anodizado en color plata mate y cantoneras redondeadas de plástico gris. Superficie laminado de alta presión rotulable en seco. Incluye cajetín reposarrotuladores de 30 cm.

Ref. /M - Versión mate apta para proyectar.

LAMINATED WHITEBOARD

ENG Whiteboard equipped with silver anodised aluminium frame and grey plastic rounded corners. Surface is high pressure laminated and suitable for writing with dry wipe board markers. A 30 cm. pen tray included.

Ref. /M - Matt version for projection.

TABLEAU STRATIFIÉ

FRA Tableau blanc stratifié avec encadrement en aluminium anodisé couleur argent aux coins arrondis en plastique gris. Surface mélaminée effaçable à sec. Livré avec un auget porte marqueurs de 30 cm.

Ref. /M - blanc mate pour projection.



SOPORTE T

REF	↑	└	⇄	□
705/L	190	100 x 80	53	30
706/L	190	100 x 120	53	30
713/L	190	120 x 150	53	30
714/L	190	120 x 200	53	30



SOPORTE DELTA

REF	↑	└	⇄	□
707/L	190	100 x 80	53	30
708/L	190	100 x 120	53	30
715/L	190	120 x 150	53	30
716/L	190	120 x 200	53	30



SOPORTE Y2

REF	↑	└	⇄	□
725/3 + Y2/80	181	80 x 120	53	30
725/4 + Y2/120	181	100 x 120	53	30
725/5 + Y2/150	181	120 x 150	53	30
725/6 + Y2/175	181	120 x 175	53	30
725/7 + Y2/200	181	120 x 200	53	30

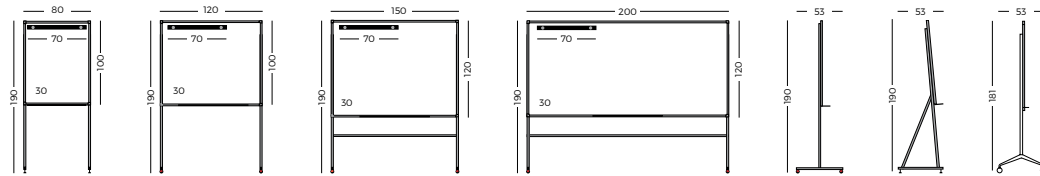

PS CAPTURE

App by Planning Sisplamo
planningsisplamo.com/pscapture

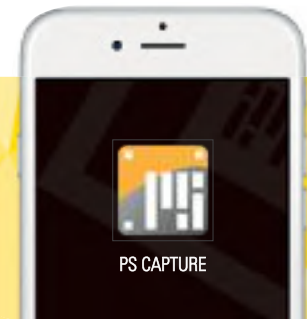

ACCESORIOS

REF: 7012

REF: 7014

REF: 7005

REF: 7008





720

PIZARRA DE **ACERO VITRIFICADO**
ENAMELLED WHITEBOARD
TABLEAU ÉMAILLÉ

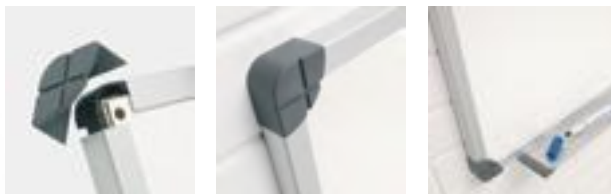

REF	L	H	RAIL
720/10	40 x 60	2.2	30 -
720/1	60 x 80	2.2	30 -
720/2	80 x 100	2.2	30 ✓
720/3	100 x 120	2.2	30 ✓
720/4	100 x 150	2.2	30 ✓
720/5	100 x 175	2.2	30 ✓
720/6	120 x 200	2.2	30 -
720/7	120 x 250	2.2	30 -
720/8	120 x 300	2.2	30 -
720/9	120 x 400	2.2	30 -
720/15	150 x 300	2.2	30 -



REF	L	H	RAIL
720/4/M	120 x 150	2.2	30 ✓
720/6/M	120 x 200	2.2	30 -
720/7/M	120 x 250	2.2	30 -
720/8/M	120 x 300	2.2	30 -
720/9/M	120 x 400	2.2	30 -
720/15/M	150 x 300	2.2	30 -



PIZARRA ACERO VITRIFICADO

ESP Pizarra mural blanca enmarcada con perfil de aluminio anodizado en color plata. Superficie magnética de acero vitrificado a 800°C con garantía de por vida. Rotulable en seco. Incluye cajetín de 30 cm. Ref. /M - Versión mate apta para proyectar.

ENAMELLED WHITEBOARD

ENG Whiteboard equipped with silver anodised aluminium frame and plastic rounded corners. Surface enamelled at 800°C, suitable for writing with dry wipe board markers. 30 cm en tray included. Lifetime warranty. Ref. /M - Matt version for projection.

TABLEAU ÉMAILLÉ

FRA Tableau émaillé blanc avec encadrement en aluminium anodisé couleur argent aux coins arrondis en plastique. Surface magnétique émaillée vitrifiée à 800°C. Livré avec auget porte marqueurs de 30 cm. Garantie à vie. Ref. /M - blanc mate pour projection.



SOPORTE T

REF	↑	↳	⇄	☐
705/A	190	100 x 80	53	30
706/A	190	100 x 120	53	30
713/A	190	100 x 150	53	30
714/A	190	120 x 200	53	30



SOPORTE DELTA

REF	↑	↳	⇄	☐
707/A	190	100 x 80	53	30
708/A	190	100 x 120	53	30
715/A	190	100 x 150	53	30
716/A	190	120 x 200	53	30



SOPORTE Y2

REF	↑	↳	⇄	☐
720/2 + Y2/80	173	100 x 80	53	30
720/3 + Y2/120	173	100 x 120	53	30
720/4 + Y2/150	173	100 x 150	53	30
720/6 + Y2/200	173	120 x 200	53	30

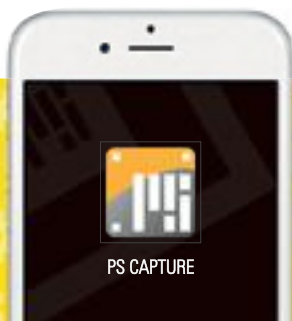
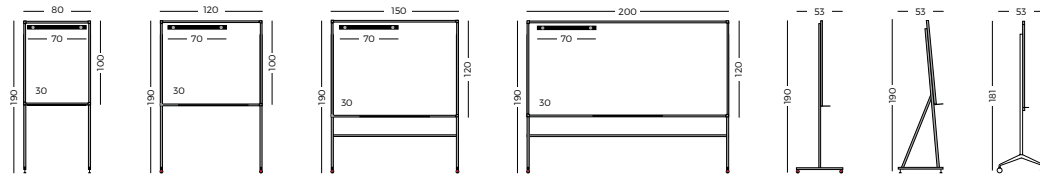

PS CAPTURE
App by Planning Sisplamo
planningsisplamo.com/pscapture

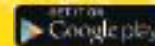
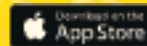

ACCESORIOS

REF: 7006

REF: 7005

REF: 7019

REF: 9002





720/C-720/P

CUADRICULADA / PENTAGRAMA
 GRIDDED / PENTAGRAM
 QUADRILLÉ / PENTAGRAMME

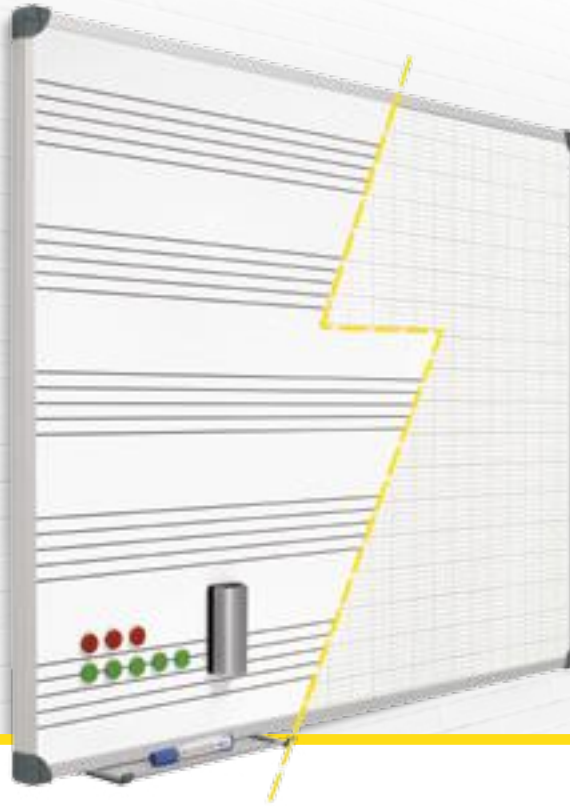

REF	L	H	RAIL	RAIL
720/C1	45 x 60	2.2	30	-
720/C2	60 x 90	2.2	30	-
720/C3	90 x 120	2.2	30	✓
720/C4	120 x 180	2.2	30	✓

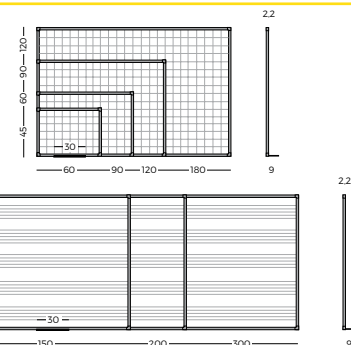
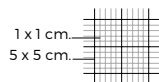

PIZARRA

ESP Pizarra mural blanca cuadrículada y/o pentagrama con perfil de aluminio anodizado en color plata mate y cantoneras redondeadas de plástico gris. Superficie de acero vitrificado a 800°C rotulable en seco. Incluye cajetín reposarrotuladores de 30 cm.

WHITEBOARD

ENG Grid and/or pentagram whiteboard equipped with silver anodised aluminium frame and grey plastic rounded corners. Surface enamelled at 800°C is suitable for writing with dry wipe board markers. A 30 cm pen tray is included.

REF	L	H	RAIL	RAIL
720/P1	120 x 150	2.2	30	✓
720/P2	120 x 200	2.2	30	-
720/P3	120 x 300	2.2	30	-



TABLEAU

FRA Tableau blanc quadrillé et/ou pentagramme avec encadrement en aluminium anodisé couleur argent aux coins arrondis en plastique gris. Surface magnétique émaillée vitrifiée à 800°C effaçable à sec. Livré avec un auget porte marqueurs de 30 cm.



SOPORTE T

REF	↑	↳	⇄	☑
720/C3/T	190	90 x 120	53	30
720/C4/T	190	120 x 180	53	30
720/P1/T	190	120 x 150	53	30
720/P2/T	190	120 x 200	53	30



SOPORTE DELTA

REF	↑	↳	⇄	☑
720/C3/D	190	90 x 120	53	30
720/C4/D	190	120 x 180	53	30
720/P1/D	190	120 x 150	53	30
720/P2/D	190	120 x 200	53	30



SOPORTE Y2

REF	↑	↳	⇄	☑
+ Y2/120	173	100 x 120	53	30
+ Y2/150	173	100 x 150	53	30
+ Y2/200	173	120 x 200	53	30

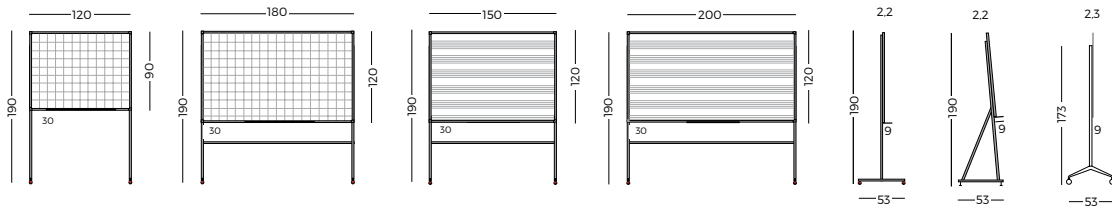

PS CAPTURE

App by Planning Sisplamo
planningsisplamo.com/pscapture



ACCESORIOS

REF: 7015



REF: 7005



REF: 7019



REF: 9002





724

PIZARRA BLANCA "MINI"
WHITEBOARD "MINI"
TABLEAU BLANC "MINI"



REF	L	H	RAIL	RAIL
724/10	40 x 60	2.3	30	-
724/1	60 x 80	2.3	30	-
724/2	80 x 100	2.3	30	✓
724/3	100 x 120	2.3	30	✓
724/4	100 x 150	2.3	30	✓
724/5	100 x 175	2.3	30	✓
724/6	120 x 200	2.3	30	-

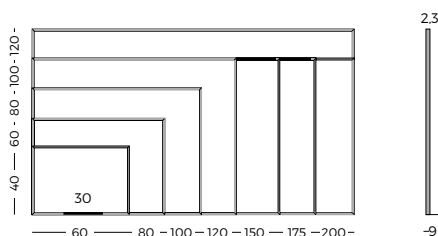

REF	L	H	RAIL	RAIL
724/10/LC	45 x 60	2.3	30	-
724/1/LC	60 x 90	2.3	30	-
724/2/LC	80 x 100	2.3	30	✓
724/3/LC	90 x 120	2.3	30	✓
724/4 /LC	100 x 150	2.3	30	✓
724/5 /LC	100 x 175	2.3	30	✓
724/6 /LC	100 x 200	2.3	30	-



PIZARRA "MINI"

ESP Pizarra mural blanca enmarcada a inglete con perfil de aluminio anodizado "Mini" en color plata mate. Superficie magnética de acero vitrificado a 800°C con garantía de por vida o lacada. Rotulable en seco. Incluye cajetín reposarrotuladores de 30 cm.

WHITEBOARD "MINI"

ENG Whiteboard equipped with matt silver anodised "Mini" aluminium frame and mitred corners. Lifetime guarantee and magnetic 800°C enamel surface or lacquered. Suitable for writing with dry wipe board markers. A 30 cm pen tray included.

TABLEAU "MINI"

FRA Tableau émaillé blanc avec encadrement en aluminium anodisé "Mini" couleur argent mate. Surface magnétique émaillée vitrifiée à 800°C "ou lacqué. Garantie à vie". Ref. /M - blanc pour projection. Livré avec auget porte marqueurs de 30 cm.



SOPORTE T

REF	↓	└	┆┆	□
724/T2	190	100 x 80	53	30
724/T3	190	100 x 120	53	30
724/T4	190	100 x 150	53	30
724/T6	190	120 x 200	53	30



SOPORTE DELTA

REF	↓	└	┆┆	□
724/D2	190	100 x 80	53	30
724/D3	190	100 x 120	53	30
724/D4	190	100 x 150	53	30
724/D6	190	120 x 200	53	30



SOPORTE Y2

REF	↓	└	┆┆	□
724/Y2	173	100 x 80	53	30
724/Y3	173	100 x 120	53	30
724/Y4	173	100 x 150	53	30
724/Y6	173	120 x 200	53	30

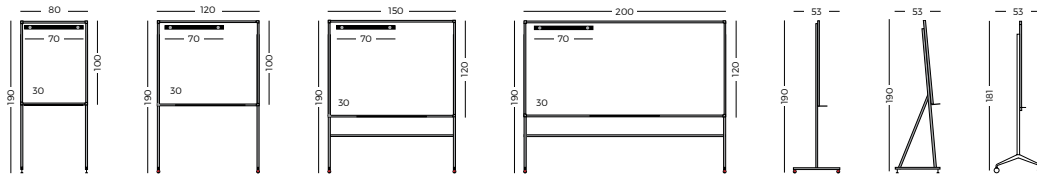

PS CAPTURE
App by Planning Sisplamo
planningsisplamo.com/pscapture



ACCESORIOS

REF: 7006

REF: 7005

REF: 9004

REF: 7019





728

PIZARRA DE **CRISTAL MAGNÉTICA**
MAGNETIC GLASS BOARD
 TABLEAU EN **VERRE MAGNÉTIQUE**

**COLOR CRISTAL**

Consultar para colores especiales.

REF	L	H	RAIL
728/1	45 x 60	0,3	-
728/2	60 x 90	0,3	-
728/3	90 x 120	0,3	-
728/4	100 x 150	0,3	-

**PIZARRA DE CRISTAL MAGNÉTICA**

ESP Pizarra magnética de cristal traslúcido sin marco de 3 mm de grosor. Superficie rotulable con rotuladores de borrado en seco. Incorpora elementos de fijación a pared y cajetín reposarrotuladores de 30 cm. junto a borrador especial e imanes de neodimio.

MAGNETIC GLASSBOARD

ENG Translucid 3 mm. thick magnetic glass board without frame. Surface is suitable for writing with dry wipe board markers. Wall-mounted brackets are included.

TABLEAU EN VERRE MAGNÉTIQUE

FRA Tableau en verre magnétique sans profil de 3 mm d'épaisseur. surface pour feutre effaçables à sec, livré avec les éléments de fixation murale et auget, ainsi qu'un effaceur et des aimants.

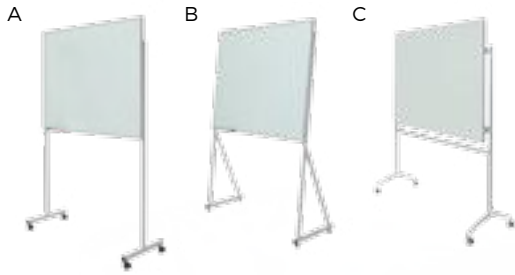

PIZARRA DE CRISTAL MAGNÉTICA
MAGNETIC GLASS BOARD
TABLEAU EN VERRE MAGNÉTIQUE

728/M



REF	L	H
728/M1	60 x 80	2.3
728/M2	80 x 100	2.3
728/M3	100 x 120	2.3
728/M4	100 x 150	2.3
728/M5	100 x 175	2.3

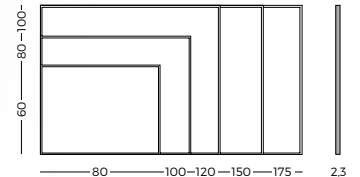

A SOPORTE T

REF	H	L	H
728/M2/T	190	100 x 80	53
728/M3/T	190	100 x 120	53
728/M4/T	190	100 x 150	53
728/M5/T	190	100 x 175	53

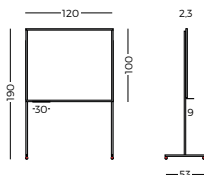

PIZARRA DE CRISTAL MAGNÉTICA

ESP Pizarra de cristal laminado de 4+0.8 mm. translúcido enmarcada. Superficie rotulable con rotuladores de borrado en seco. Incorpora elementos de fijación a pared y cajetín.

B SOPORTE DELTA

REF	H	L	H
728/M2/D	190	100 x 80	53
728/M3/D	190	100 x 120	53
728/M4/D	190	100 x 150	53
728/M5/D	190	100 x 175	53

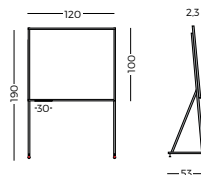

MAGNETIC GLASSBOARD

ENG Translucent laminated 4+1 mm. thick glass board without frame. Surface is suitable for writing with dry wipe board markers. Wall-mounted brackets are included and pen tray.

C SOPORTE Y2

REF	H	L	H
728/M2/Y	181	100 x 80	53
728/M3/Y	181	100 x 120	53
728/M4/Y	181	100 x 150	53
728/M5/Y	181	100 x 175	53



TABLEAU EN VERRE MAGNÉTIQUE

FRA Tableau en verre laminé magnétique 4+1 mm. Surface pour feutre effaçables à sec, livré avec les éléments de fixation murale et un auget.

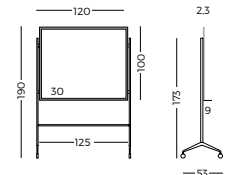

ZENIT

PIZARRA BLANCA "ZENIT"
WHITEBOARD "ZENIT"
TABLEAU BLANC "ZENIT"

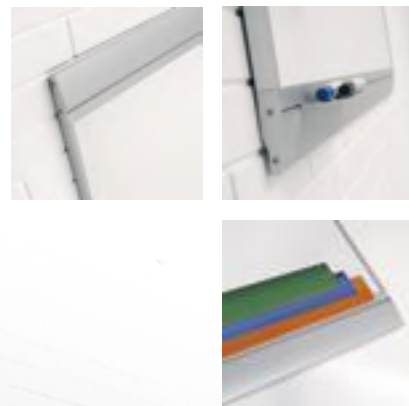

PERFIL LACADO



* /NG /BL /AM /RJ /AZ /VD /NJ

REF	L	H	RAIL	RAIL
Z/720/1	60 x 80	2.3	30	-
Z/720/2	80 x 100	2.3	30	✓
Z/720/3	100 x 120	2.3	30	✓
Z/720/4	100 x 150	2.3	30	✓
Z/720/5	100 x 175	2.3	30	✓
Z/720/6	120 x 200	2.3	30	-
Z/720/7	120 x 250	2.3	30	-

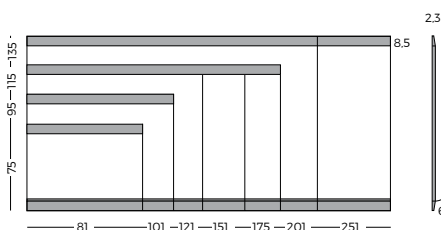

REF	L	H	RAIL	RAIL
Z/725/1	60 x 80	2.3	30	-
Z/725/2	80 x 100	2.3	30	✓
Z/725/3	100 x 120	2.3	30	✓
Z/725/4	120 x 150	2.3	30	✓
Z/725/5	120 x 175	2.3	30	✓
Z/725/6	120 x 200	2.3	30	-
Z/725/7	120 x 250	2.3	30	-



PIZARRA BLANCA "ZENIT"

ESP Pizarra mural blanca Zénit de acero vitrificado/laminado enmarcada con perfil de aluminio anodizado en color plata mate (tapa personalizable). Superficie magnética de acero vitrificado a 800°C rotulable en seco o lacada. Incluye cajetín reposarrotuladores de 30 cm.

WHITEBOARD "ZENIT"

ENG Enamelled steel whiteboard with anodized aluminium frame (customizable). Surface enamelled at 800°C is suitable for writing with dry wipe board markers. Includes a marker-holder 30 cm.

TABLEAU BLANC "ZENIT"

FRA Tableau blanc Zénit en acier émaillé avec encadrement aluminium anodisé de couleur argent mate (personnalisable). Surface magnétique émaillée vitrifiée à 800°C effaçable à sec. Livré avec auget porte-marqueur 30 cm.

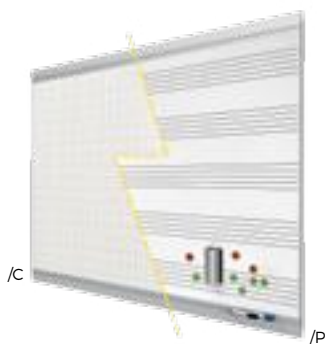

/C - /P

REF ↙ ↘ ☐

Z/720/C1	45 x 60	2,3	30
Z/720/C2	60 x 90	2,3	30
Z/720/C3	90 x 120	2,3	30
Z/720/C4	120 x 180	2,3	30
Z/720/P1	120 x 150	2,3	30
Z/720/P2	120 x 200	2,3	30
Z/720/P3	120 x 300	2,3	30



SOPORTE Y2

REF ↓ ↙ ↘ ☐

Z/720/Y2	181	100 x 80	53	30
Z/720/Y3	181	100 x 120	53	30
Z/720/Y4	181	100 x 150	53	30
Z/720/Y6	181	120 x 200	53	30



SOPORTE Y2

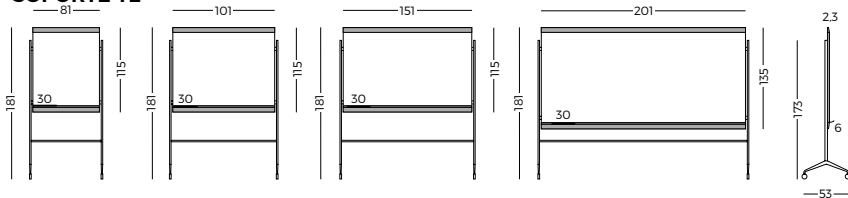

PIZARRA CUADRICULA & PENTAGRAMA

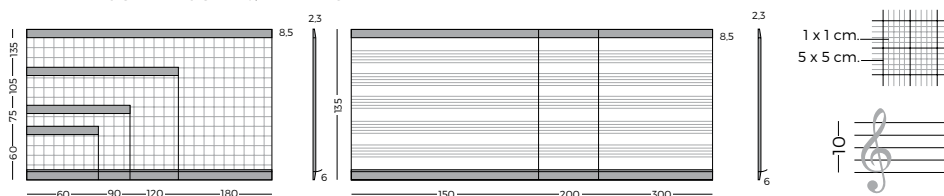

ACCESORIOS

REF: 7015



REF: 7005



REF: 7019



PS CAPTURE

App by Planning Sisplamo
planningsisplamo.com/pscapture





RAIL

SISTEMA RAÍL
RAIL SYSTEM
SYSTÈME RAIL



REF	I	II
RP/000	-	8
RP/100	100	8
RP/200	200	8
RP/300	300	8

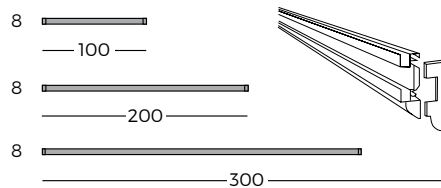

RAIL

ESP Rail plan es el sistema que mediante un perfil de aluminio lacado blanco, fijado a la pared, permite colgar en sus dos carriles, pizarras, tableros, etc.... desplazarlos longitudinalmente y hacer posible cualquier tipo de presentación, etc.

RAIL

ENG Rail's Plan lacquered aluminium profile fixed on a wall allows you to hang all types of boards and move them horizontally to help with your presentations and exhibitions. Below the lower rail you will find fittings suitable for hanging note pads, etc.

RAIL

FRA Système de rail en aluminium (blanc laqué) en fixation murale pour superposer et faire coulisser des tableaux sur deux hauteurs de rail, idéal pour les présentations dans le bureau ou en salle de cours. Les documents seront soutenus par pression sous le rail.



ZENIT

REF L H D

Z/720/2	80 x 100	6	30
Z/720/3	100 x 120	6	30
Z/720/4	100 x 150	6	30
Z/720/5	100 x 175	6	30

720 / 725

REF L H D

720/2	80 x 100	6	30
720/3	100 x 120	6	30
720/4	100 x 150	6	30
720/5	100 x 175	6	30
725/3	80 x 100	6	30
725/4	100 x 120	6	30
725/5	100 x 150	6	30
725/6	120 x 175	6	30

760 / 765

REF L H D

760/2	80 x 100	2.2	-
760/3	100 x 120	2.2	-
760/4	100 x 150	2.2	-
760/5	100 x 175	2.2	-
765/2	80 x 100	2.2	-
765/3	100 x 120	2.2	-
765/4	100 x 150	2.2	-
765/5	100 x 175	2.2	-

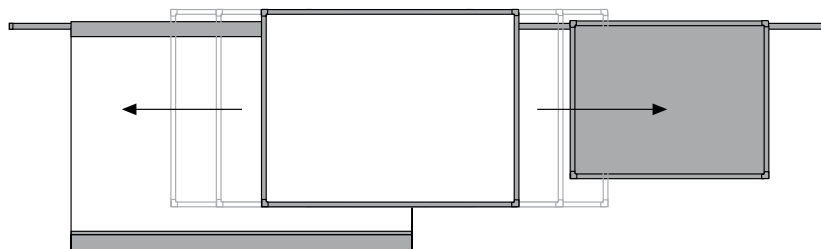
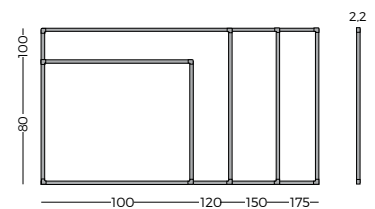
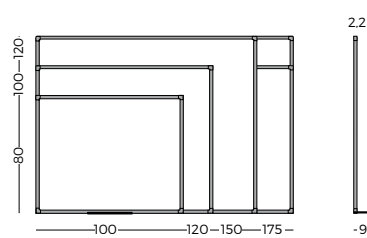
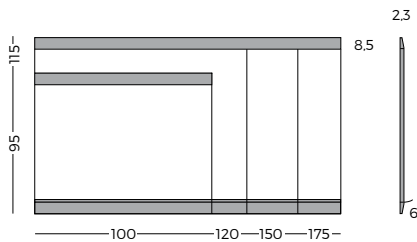

ACCESORIOS RAIL

REF L D

RP/30	2.5	5
-------	-----	---



REF L D

RP/L	5 x 8	90°
------	-------	-----

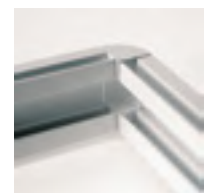



SOPORTES DE PIE
FLOOR SUPPORTS
PIÉTEMENTS ET SUPORTS



REF	↑	—	max	REF	↑	—	max	REF	↑	—	max	
Y2/80/R	Y2/80/N	173	53	80	770/1	174	53	120 x 200	770/2	174	53	120 x 200
Y2/120/R	Y2/120/N	173	53	120								
Y2/150/R	Y2/150/N	173	53	150								
Y2/175/R	Y2/175/N	173	53	175								
Y2/200/R	Y2/200/N	173	53	200								

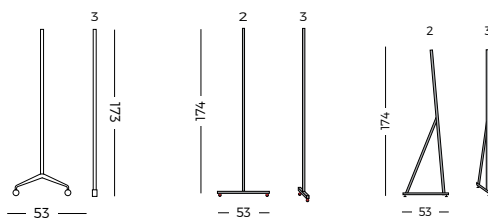

SOPORTES

ESP "Y2": Juego de soportes, fabricados en perfil de aluminio y pié de fundición. Incorpora ruedas con freno o niveladores. "T" + Delta: Juego de soportes metálicos, para adaptar pizarras, tableros, etc. Uso aconsejable hasta 2 metros de largo.

SUPPORTS

ENG "Y2" Set of 2 aluminium and cast-iron supports with castors or jacks for whiteboard. Suitable for all showcases, boards and panels. "T" support with 4 castors (2 of them with brakes). Recommended for lengths of up to 2 meters.

PIÉTEMENTS

FRA "Y2" Jeu de 2 piétements métalliques en aluminium et fonte. Livré avec roulettes (munies de freins). "T" + Delta : jeu de support métalliques pour adapter tableaux, vitrines... Taille recommandée du support jusqu'à 2m de large.



**SOPORTE Y TRÍPODE
SUPPORTS & TRIPOD
PIÈTEMENTS ET SUPPORTS**



REF	↑	→	↑max
770/6	190	70	120 x 90

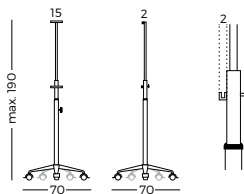

SOPORTES

ESP Soporte para tableros y pizarras fabricado con tubo metálico. Regulable en altura. La Ref. 770/6 incorpora de serie ruedas dotadas de freno. Medidas de 60 x 80 cm. hasta 100 x 120 cm.

REF	↑	→	↑max
770/5	160	90	100 x 120

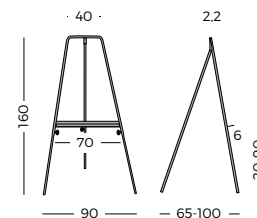

SUPPORTS

ENG Support for cork boards and slates made with metal tube. Adjustable in height. Ref. 770/6 incorporates standard wheels with brake. Sizes between 60 x 80 cm. until 100 x 120 cm.

CHEVALET

FRA Support pour tableaux fabriqués avec tubes métalliques. Réglable en hauteur. La réf. 770/6 incorpore de série des roues dotées de frein. Mesures entre 60 x 80cm. en haut 100 x 120 cm.



720/D-T

PIZARRA **DIPTICA / TRIPTICA**
DOUBLE / TRIPLE PANEL WHITEBOARD
 TABLEAU BLANC **DYPTIQUE / TRIPTYQUE**



REF    

720/D1 90 x 120 90 x 60 2 + 2 30
720/D2 120 x 180 120 x 90 2 + 2 30

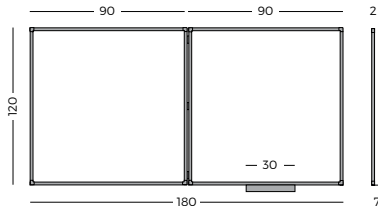

PIZARRA

WHITEBOARD

ESP Pizarra blanca díptica o tríptica de acero vitrificado enmarcada con perfil de aluminio anodizado en color plata mate y cantoneras redondeadas de plástico gris. Superficie de acero vitrificado a 800°C rotulable en seco. Reposarrotuladores de 30 cm. incluido. La díptica posee 3 superficies de escritura y la tríptica 5.

ENG Whiteboard equipped with silver anodised aluminium frame and grey plastic rounded corners. Surface enamelled at 800°C is suitable for writing with dry wipe board markers. A 30 cm. pen tray is included. The double paneled has 3 writing surfaces and the triple paneled whiteboard has 5 surfaces.

REF    

720/T1 90 x 240 90 x 120 2 + 4 30
720/T2 120 x 400 120 x 200 2 + 4 30

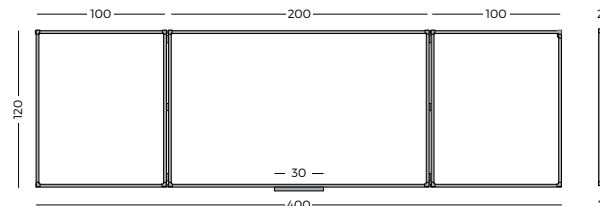

TABLEAU

FRA Tableau blanc en acier émaillé, diptyque avec cadre en aluminium anodisé couleur argent aux coins arrondis en plastique gris. Surface magnétique émaillée vitrifiée à 800°C effaçable à sec. Livré avec un auget de 30 cm. Le tableau diptyque a trois surfaces d'écriture et la triptyque 5.

PIZARRA BLANCA VOLTEABLE
REVOLVING WHITEBOARD
 TABLEAU BLANC PIVOTANT

720-725/X



REF	↑	L	⇄	□
720/X1	210	120 x 150	1,5	100
720/X2	210	120 x 175	1,5	100
720/X3	210	120 x 200	1,5	100

REF	↑	L	⇄	□
725/X1	210	120 x 150	1,5	100
725/X2	210	120 x 175	1,5	100
725/X3	210	120 x 200	1,5	100

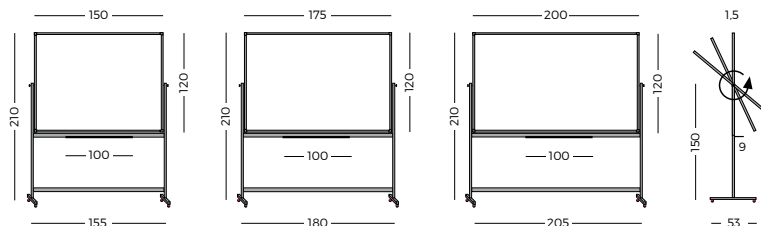

PIZARRA

ESP Pizarra blanca volteable doble cara enmarcada con perfil de aluminio anodizado en color plata mate y cantoneras redondeadas de plástico gris. Superficie de doble escritura rotulable en seco. Estructura volteable metálica móvil provista de 4 ruedas (2 de ellas con freno).

WHITEBOARD

ENG Revolving whiteboard equipped with silver anodised aluminium frame and grey plastic rounded corners. Double side surface is suitable for writing with dry wipe board markers. Metallic moveable support equipped with 4 castors (2 of them with brake).

TABLEAU

FRA Tableau blanc rotatif avec encadrement en aluminium anodisé argent aux coins arrondis en plastique gris. Monté sur piétement. Double surface d'écriture effaçable à sec. Support métallique équipé de 4 roulettes (donc 2 à freins).



REF L H □

- * **720/H4** 120 x 400 9 400
- * **720/H5** 120 x 500 9 500
- * **720/H6** 120 x 600 9 600
- * **720/H8** 120 x 800 9 800

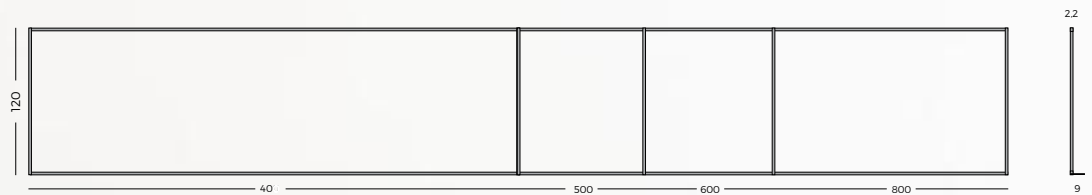

*En 2 piezas / 2 pieces / En 2 parties

PIZARRA HORIZON

ESP Pizarra mural blanca enmarcada con perfil de aluminio anodizada de hasta 8 metros de longitud. Superficie magnética rotulable en seco de acero vitrificado a 800°C con garantía de por vida. Todas las pizarras se fabrican en 2 piezas. Incluye gancho porta planos.

HORIZON WHITEBOARD

ENG Framed white board with anodized aluminum profile up to 8 meters in length. Magnetic surface can be labeled dry in vitrified steel at 800°C with lifetime warranty. All boards are made in 2 pieces. Map's hook included.

TABLEAU HORIZON

FRA Tableau mural blanc, encadrement en aluminium anodisé, jusqu'à 8 mètres de longueur. Superficie magnétique en émail (800°C), surface d'écriture effaçable à sec. Garantie à vie. Tous les tableaux de cette référence sont fabriqués en deux pièces. Inclus deux crochets pour plans.



PIZARRA GRAN FORMATO
WHITEBOARD BIG SIZE
TABLEAU CONFÉRENCE

HORIZON

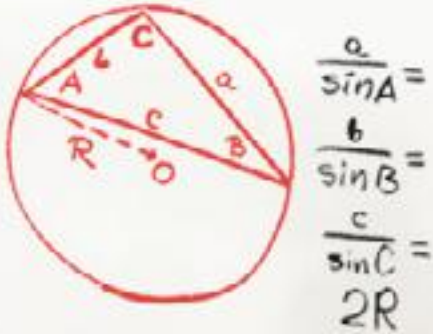

REF L H □

* 720/H4/M	120 x 400	9	400
* 720/H5/M	120 x 500	9	500
* 720/H6/M	120 x 600	9	600
* 720/H8/M	120 x 800	9	800





720/VV

PIZARRA DE VAIVÉN
VAIVÉN BOARD
TABLEAU VA-ET-VIENT

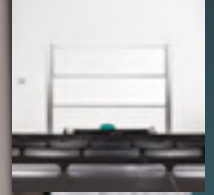

PIZARRA DE VAIVÉN
VAIVÉN BOARD
TABLEAU VA-ET-VIENT

PIZARRA DE VAIVÉN
VAIVÉN BOARD
TABLEAU VA-ET-VIENT

PIZARRA DE VAIVÉN
VAIVÉN BOARD
TABLEAU VA-ET-VIENT

PIZARRA DE VAIVÉN
VAIVÉN BOARD
TABLEAU VA-ET-VIENT

PIZARRA DE VAIVÉN
VAIVÉN BOARD
TABLEAU VA-ET-VIENT

PIZARRA DE VAIVÉN
VAIVÉN BOARD
TABLEAU VA-ET-VIENT

PIZARRA DE VAIVÉN
VAIVÉN BOARD
TABLEAU VA-ET-VIENT

PIZARRA DE VAIVÉN
VAIVÉN BOARD
TABLEAU VA-ET-VIENT

PIZARRA DE VAIVÉN
VAIVÉN BOARD
TABLEAU VA-ET-VIENT

PIZARRA DE VAIVÉN
VAIVÉN BOARD
TABLEAU VA-ET-VIENT

PIZARRA DE VAIVÉN
VAIVÉN BOARD
TABLEAU VA-ET-VIENT

PIZARRA DE VAIVÉN
VAIVÉN BOARD
TABLEAU VA-ET-VIENT

PIZARRA DE VAIVÉN
VAIVÉN BOARD
TABLEAU VA-ET-VIENT

PIZARRA DE VAIVÉN
VAIVÉN BOARD
TABLEAU VA-ET-VIENT

PIZARRA DE VAIVÉN
VAIVÉN BOARD
TABLEAU VA-ET-VIENT

PIZARRA DE VAIVÉN
VAIVÉN BOARD
TABLEAU VA-ET-VIENT

PIZARRA DE VAIVÉN
VAIVÉN BOARD
TABLEAU VA-ET-VIENT

PIZARRA DE VAIVÉN
VAIVÉN BOARD
TABLEAU VA-ET-VIENT

PIZARRA DE VAIVÉN
VAIVÉN BOARD
TABLEAU VA-ET-VIENT

PIZARRA DE VAIVÉN
VAIVÉN BOARD
TABLEAU VA-ET-VIENT

PIZARRA DE VAIVÉN
VAIVÉN BOARD
TABLEAU VA-ET-VIENT

PIZARRA DE VAIVÉN
VAIVÉN BOARD
TABLEAU VA-ET-VIENT

PIZARRA DE VAIVÉN
VAIVÉN BOARD
TABLEAU VA-ET-VIENT

PIZARRA DE VAIVÉN
VAIVÉN BOARD
TABLEAU VA-ET-VIENT

PIZARRA DE VAIVÉN
VAIVÉN BOARD
TABLEAU VA-ET-VIENT

PIZARRA DE VAIVÉN
VAIVÉN BOARD
TABLEAU VA-ET-VIENT

PIZARRA DE VAIVÉN
VAIVÉN BOARD
TABLEAU VA-ET-VIENT

PIZARRA DE VAIVÉN
VAIVÉN BOARD
TABLEAU VA-ET-VIENT

PIZARRA DE VAIVÉN
VAIVÉN BOARD
TABLEAU VA-ET-VIENT

PIZARRA DE VAIVÉN
VAIVÉN BOARD
TABLEAU VA-ET-VIENT

PIZARRA DE VAIVÉN
VAIVÉN BOARD
TABLEAU VA-ET-VIENT

PIZARRA DE VAIVÉN
VAIVÉN BOARD
TABLEAU VA-ET-VIENT

PIZARRA DE VAIVÉN
VAIVÉN BOARD
TABLEAU VA-ET-VIENT

PIZARRA DE VAIVÉN
VAIVÉN BOARD
TABLEAU VA-ET-VIENT

PIZARRA DE VAIVÉN
VAIVÉN BOARD
TABLEAU VA-ET-VIENT

PIZARRA DE VAIVÉN
VAIVÉN BOARD
TABLEAU VA-ET-VIENT

PIZARRA DE VAIVÉN
VAIVÉN BOARD
TABLEAU VA-ET-VIENT

PIZARRA DE VAIVÉN
VAIVÉN BOARD
TABLEAU VA-ET-VIENT

PIZARRA DE VAIVÉN
VAIVÉN BOARD
TABLEAU VA-ET-VIENT

PIZARRA DE VAIVÉN
VAIVÉN BOARD
TABLEAU VA-ET-VIENT

PIZARRA DE VAIVÉN
VAIVÉN BOARD
TABLEAU VA-ET-VIENT

PIZARRA DE VAIVÉN
VAIVÉN BOARD
TABLEAU VA-ET-VIENT

PIZARRA DE VAIVÉN
VAIVÉN BOARD
TABLEAU VA-ET-VIENT

PIZARRA DE VAIVÉN
VAIVÉN BOARD
TABLEAU VA-ET-VIENT

PIZARRA DE VAIVÉN
VAIVÉN BOARD
TABLEAU VA-ET-VIENT

PIZARRA DE VAIVÉN
VAIVÉN BOARD
TABLEAU VA-ET-VIENT

PIZARRA DE VAIVÉN
VAIVÉN BOARD
TABLEAU VA-ET-VIENT

PIZARRA DE VAIVÉN
VAIVÉN BOARD
TABLEAU VA-ET-VIENT

PIZARRA DE VAIVÉN
VAIVÉN BOARD
TABLEAU VA-ET-VIENT

PIZARRA DE VAIVÉN
VAIVÉN BOARD
TABLEAU VA-ET-VIENT

PIZARRA DE VAIVÉN
VAIVÉN BOARD
TABLEAU VA-ET-VIENT

PIZARRA DE VAIVÉN
VAIVÉN BOARD
TABLEAU VA-ET-VIENT

PIZARRA DE VAIVÉN
VAIVÉN BOARD
TABLEAU VA-ET-VIENT

PIZARRA DE VAIVÉN
VAIVÉN BOARD
TABLEAU VA-ET-VIENT

PIZARRA DE VAIVÉN
VAIVÉN BOARD
TABLEAU VA-ET-VIENT

PIZARRA DE VAIVÉN
VAIVÉN BOARD
TABLEAU VA-ET-VIENT

REF	↑	└	⊞
720/2/VV1	x	120 x 200	12
720/2/VV2	x	120 x 250	12
720/2/VV3	x	120 x 300	12
720/2/VV4	x	120 x 400	12

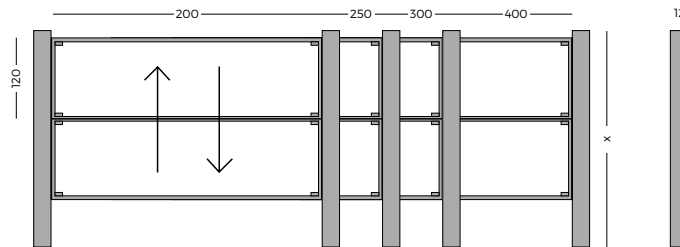

PIZARRA VAIVÉN

ESP Pizarra blanca de acero vitrificado sobre una estructura de aluminio anodizado en plata mate montada sobre suelo y pared. La pizarra se desliza y va guiada en el perfil por rodamientos de nylon. Ideales para colegios, universidades, anfiteatros...

WHITEBOARD VAIVEN

ENG Enamelled whiteboard mounted upon a supporting structure in silver anodised aluminium on stand or wall fixation. The surface slide is guided through a cable transmission. The ideal communication tool for large scale presentations, lecture theatres...

TABLEAU VA-ET-VIENT

FRA Tableau blanc émaillé monté sur une structure en aluminium anodisé couleur argent, fixation sol et mur. La surface se déplace sur le profil via des roulements. Pour une communication idéale dans les amphithéâtres, salles de congrès...



720/G

PIZARRA DE GUILLOTINA
GUILLOTINE BOARD
TABLEAU GUILLOTINE

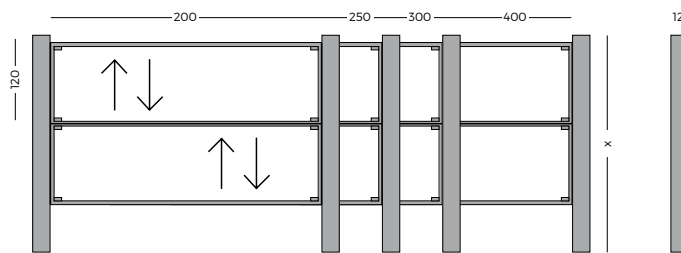

REF	↑	↶	±H
720/2/G1	x	120 x 200	12
720/2/G2	x	120 x 250	12
720/2/G3	x	120 x 300	12
720/2/G4	x	120 x 400	12



PIZARRA GUILLOTINA

ESP Conjunto de 2 pizarras blancas de acero vitrificado sobre una estructura de aluminio anodizado en plata mate montadas sobre suelo y pared. Las pizarras son independientes entre sí, guiadas por rodamiento de nylon.

GUILLOTINE BOARD

ENG 2 enamelled whiteboards mounted upon a supporting structure in silver anodised aluminium on stand or wall fixation. Both writing surfaces slide vertically and are interdependent or each other. Guidance by nylon castors.

TABLEAU GUILLOTINE

FRA Ensemble de 2 tableaux blancs émaillés montés sur une structure en aluminium anodisé couleur argent, fixation sol et mur. Les deux surfaces se déplacent de façon indépendantes et sont guidées par des roulements.



WALL

MURO DE ESCRITURA
WHITEBOARD WALL
MUR D'ECRITURE MULTIWALL



MURO DE ESCRITURA

ESP Muro de escritura de acero vitrificado a 800°C blanco enmarcado con perfil de aluminio lacado, el conjunto se consigue adosando lateralmente pizarras de 200cm x 100cm. de manera vertical en la pared consiguiendo así la superficie deseada.

WALL BOARD

ENG White vitrified steel at 800°C writing wall framed with lacquered aluminum profile, the set is achieved by laterally laying white boards 200 x 100 vertically on the wall thus achieving the desired surface.

TABLEAU MUR

FRA Mur d'écriture en acier émaillé (à 800°C) blanc, encadrement en aluminium laqué. L'ensemble se constitue de panneaux verticaux muraux de 200 x 100.

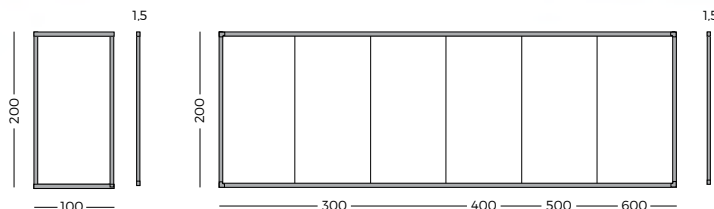

REF	L	H
720/W3	300 x 100	1.5
720/W4	400 x 100	1.5
720/W5	500 x 100	1.5
720/W6	600 x 100	1.5





PS PAINT

PINTURA PIZARRA
WHITEBOARD PAINT
PEINTURE TABLEAU



AREA	%
A	20
B	13
C	9
D	12
E	46

COLOR PINTURA



/BL /TR

REF	Color	Ltrs.	M ²
PNT/BL	Blanco	1	9
PNT/TR	Transparente	1	9



— 1L —

PINTURA PARED

ESP Pintura de pared con un acabado de pizarra blanca que permite escribir y dibujar sobre ella. Con dos capas son suficiente para obtener una superficie lisa de pizarra borrrable. Bote de 1L para cubrir 9 m².

WHITEBOARD PAINT

ENG Wall paint with a white board finish that allows you to write and draw on it. Two layers are sufficient enough to obtain a smooth surface of erasable white board. One 1L can is enough to cover 9 m².

PEINTURE TABLEAU

FRA Peinture murale avec finition tableau blanc permettant l'écriture ou le dessin. Deux couches sont suffisantes pour obtenir une superficie lisse et effaçable. Pot d'un litre pour environ 9 m².

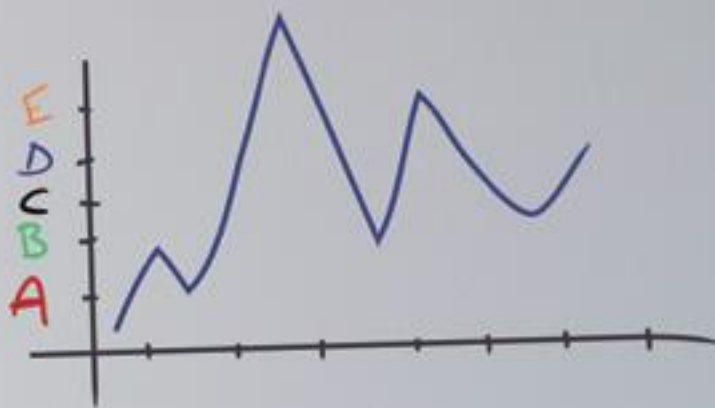

PINTURA BLANCA

ESP Aplicar dos capas de pintura blanca sobre una pared para obtener una superficie de escritura tipo pizarra.

ENG Apply two coats of whiteboard paint to a wall to create a smooth writing surface.

FRA Appliquer deux couches de peinture blanche sur le mur pour obtenir une superficie d'écriture type tableau.



PINTURA TRANSPARENTE

ESP Aplicar dos capas de pintura transparente sobre una pared pintada para obtener una superficie de escritura tipo pizarra de color.

ENG Apply two coats of transparent paint to a wall to create a smooth coloured writing surface.

FRA Appliquer deux couches de peinture transparente sur le mur pour obtenir une superficie d'écriture type tableau de couleur.



1000

PLANNING MAGNÉTICO
MAGNETIC PLANNER
PLANNING MAGNÉTIQUE

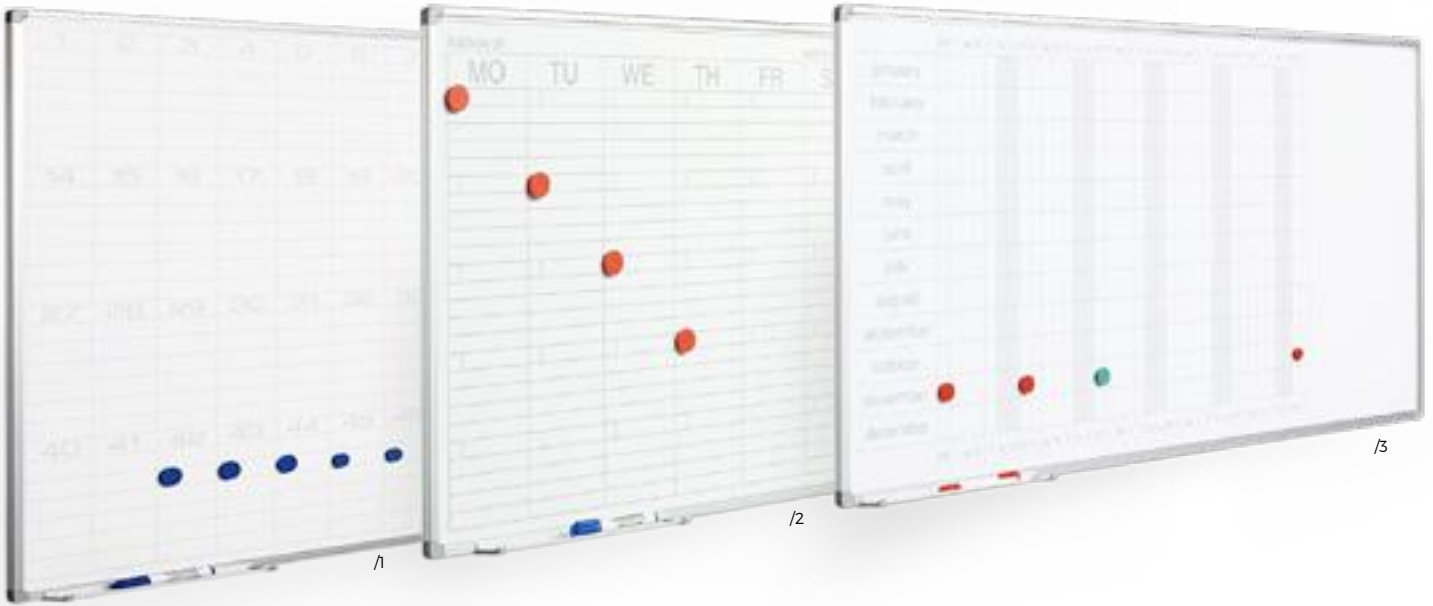
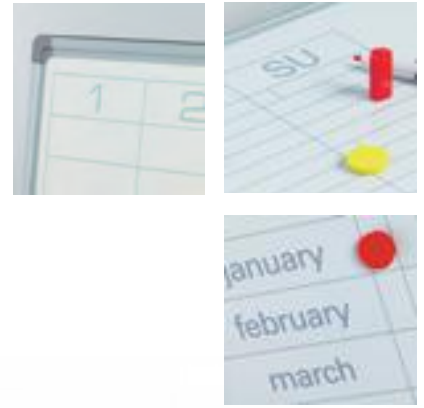

1

REF	↑	⇄	□
1000/S1	60 x 90	1,5	30
1000/S2	90 x 120	1,5	30

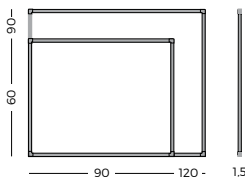

2

REF	↑	⇄	□
1000/A10	60 x 120	1,5	30



3

REF	↑	⇄	□
1000/M1	60 x 120	1,5	30

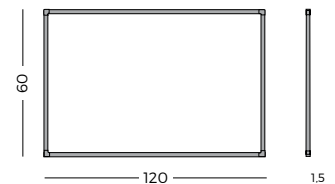

PLANNING MAGNÉTICO

ESP Planning mural serigrafiado, rotulable (borrado en seco), enmarcado con perfil de aluminio, anodizado de color plata mate y cantoneras redondeadas grises. Incluye cajetín reposarrotuladores de 30cm. Superficie lacada serigrafiada en color gris claro y permite adaptar material magnético.

MAGNETIC PLANNER

ENG Magnetic planner equipped with silver anodised aluminium frame and grey plastic rounded corners. Lacquered surface is suitable for writing on with dry wipe board markers. A 30cm. pen tray included.

PLANNING MAGNÉTIQUE

FRA Planning magnétique quadrillé avec encadrement en aluminium anodisé couleur argent et coins arrondés en plastique gris. Surface laquée en blanc effaçable à sec. Livré avec auget porte marqueurs de 30 cm.



PLANNING MAGNÉTICO
MAGNETIC PLANNER
PLANNING MAGNÉTIQUE

1000



/4
REF L -H

1000/60 90 x 120 1.5



/5
REF L -H

1000/50 90 x 120 1.5

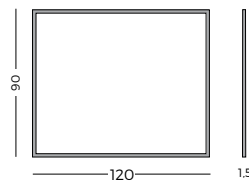

PLANNING MAGNÉTICO

ESP Planning mural blanco lacado serigrafiado, rotulable con rotuladores de borrado en seco, enmarcado con perfil de aluminio anodizado en color plata mate y cantoneras redondeadas grises. Incluye un cajetín reposarrotuladores de 30 cm.

MAGNETIC PLANNER

ENG Magnetic planner equipped with silver anodised aluminium frame and grey plastic rounded corners. Lacquered surface is suitable for writing with dry wipe board markers. A 30 cm. pen tray included.

PLANNING MAGNÉTIQUE

FRA Planning magnétique blanc quadrillé avec encadrement en aluminium anodisé couleur argent et coins arrondis en plastique gris mate. Surface laqué en blanc effaçable à sec. Livre avec auget porte marqueurs de 30 cm.



LEAN

PLANNING MAGNÉTICO
MAGNETIC **PLANNER**
PLANNING MAGNÉTIQUE



REF	↑	↑↓	□
1500/1	90 x 120	1.5	30
1500/2	100 x 150	1.5	30
1500/3	120 x 200	1.5	30

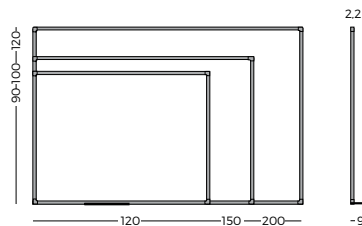

PLANNING

ESP Pizarra blanca lacada magnética con marco de aluminio, rotulable con rotuladores de borrado en seco. Superficie personalizable para implementar en fábricas, oficinas u organizar procesos. Consultar con la oficina técnica para su diseño personalizado.

PLANNER

ENG Magnetic lacquered whiteboard with aluminum frame, can be labeled with dry-erase markers. Customizable surface for use in factories, offices and for organizational processes. Consult our technical department for your custom design.

PLANNING

FRA Tableau blanc laqué magnétique, avec encadrement en aluminium, surface d'écriture effaçable à sec. Superficie personnalisable afin de l'implanter en usine, bureaux... Consultez nous pour un dessin personnalisé.

EJEMPLOS LEAN



MAGNETS CIRCULARES

REF	∅	uts./ box	diseño
KL/01	3,5	15 u. (5 x color)	emoji
KL/02	3,5	15 u. (5 x color)	tick
KL/03	3,5	15 u. (5 x color)	?
KL/04	3,5	15 u. (5 x color)	!



MAGNETS REVERSIBLES

REF	∅	uts./ box	diseño
KL/11	5	5 u.	emoji
KL/12	5	5 u.	tick
KL/13	5	5 u.	?
KL/14	5	5 u.	!



Ver página accesorios 52-53 / See pages 52-53 / Voir pages 52-53



/VD /RJ /VD /AM

MAGNETS FLECHAS

REF	L	uts./ box
KL/21	2 x 3	5



/VD /RJ /VD /AM /BL

MAGNETS FRAMES

REF	L	DIN	uts.
KL/A4	210 x 297	A4	5
KL/A3	297 x 420	A3	5



IMANES

ESP Accesorios de diferentes colores y diseños para el uso con una pizarra LEAN. Ideal para marcar procesos completados u organizar tareas industriales. Productos disponibles: Pack de 15 imanes de 3 colores, de 5 imanes de doble cara, de 5 flechas en 4 colores o fundas DIN A4 o DIN A3 de colores.

MAGNETS

ENG Accessories in a selection of different colors and designs for use with a LEAN slate. Ideal for marking completed processes or organizing industrial tasks. Available products: pack of 15 3-color magnets, 5 double-sided magnets, 5 arrows in 4 colors or DIN A4 or DIN A3 colored.

AIMANTS

FRA Accessoires de différentes couleurs et conceptions pour un usage sur tableau LEAN. Idéal pour lister ou marquer vos tâches et autres procédures. Produits disponibles : pack de 15 aimants de 3 couleurs, de 5 aimants doubles faces, de 5 flèches en 4 couleurs ou pochettes DIN A4 ou A3 de couleurs.



FLIPCHARTS

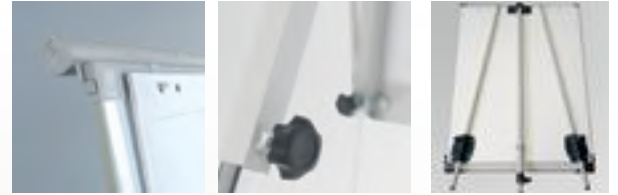

REF	H	L	HT
1 704/N	190	100 x 80	90
2 711/N	186	100 x 70	70
3 712/N	186	101 x 71	62

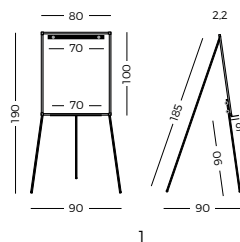

1

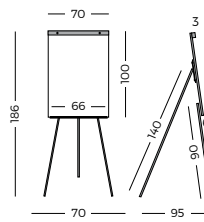

2

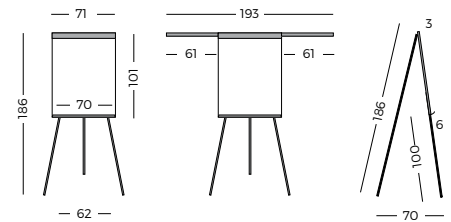

3

PIZARRA CABALLETE

ESP Pizarras de caballete lacadas con soporte tipo trípode de diferentes calidades y diseños. Superficie blanca magnética. 712/N incluye brazos extensibles en ambos lados. Soporte para blocs de papel incluido.

FLIPCHART

ENG Lacquered easel boards with tripod type stand in varied qualities and designs. Magnetic white surface. 712/N includes extendable arms. Support for paper flipcharts included.

CHEVALET

FRA Chevalet tableau de différentes qualités et conceptions. Superficie blanche magnétique. La version 712/N dispose de deux bras extensibles. Support bloc papier inclus. Hauteur réglable.

FLIPCHARTS

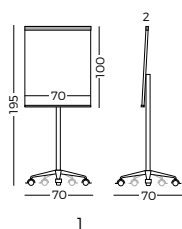

1

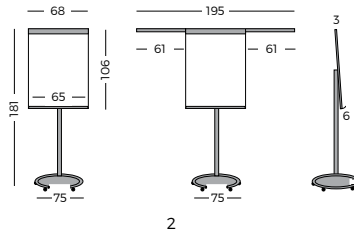

2

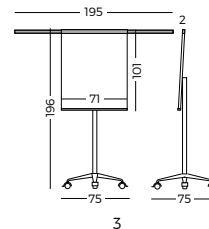

3

REF	H	L	PI
1 709/E	195	100 x 70	70
2 709/N	181	100 x 68	95
3 709/T	196	101 x 71	70



PIZARRA CABALLETE

ESP Pizarras de pie con ruedas de diferentes cualidades y diseños. Superficie blanca magnética y brazos extensibles en ambos lados en las opciones 709/T y 709/N. Soporte para blocs de papel incluido. Altura graduable.

FLIPCHART

ENG Mobile white boards on castors in varied qualities and designs. Magnetic white surface and extendable arms on both sides in options 709/T and 709/N. Support for paper pads included. Adjustable height.

CHEVALET

FRA Chevalet tableau avec roue de différentes qualités et conceptions. Superficie blanche magnétique avec bras extensibles des deux côtés pour les versions 709/T et 709/N. Support bloc papier inclus. Hauteur réglable.



ACCESORIOS

PS CAPTURE

App by Planning Sisplamo
planningsisplamo.com/pscapture



7012

ESP Borrador de aluminio

Uso para pizarras. Fieltro intercambiable.

ENG Whiteboard eraser

Use for boards. The filters are replaceable.

FRA Effaceur d'aluminium

Pour tableaux. Feutrine remplaçable.



7014

ESP Borrador de plástico

Uso para pizarras. Fieltro intercambiable.

ENG Plastic eraser

Use for boards. The filters are replaceable.

FRA Effaceur en plastique

Pour tableaux. Feutrine remplaçable.



7015

ESP Borrador magnético "Design"

Obertura para guardar fieltros y/o rotuladores.

ENG "Design" magnetic eraser

Open for keeping up dry erase pens &/or refills.

FRA Effaceur magnétique "Design"

Ouvert pour ranger feutrinnes et/ou marqueurs.



7006

ESP Borrador de aluminio magnético

Uso para pizarras. Fieltro intercambiable.

ENG Magnetic whiteboard eraser

Use for boards. The filters are replaceable.

FRA Effaceur magnétique

Pour tableaux. Feutrine remplaçable.



7014/1

ESP Recambio para borrador de plástico

2 uds. de fieltros para borrador ref. 7014

ENG Plastic eraser refill

Box of 2 refills for board eraser ref. 7014

FRA Feutrinnes de remplacement effaceur

Jeu de 2 unités de feutrinnes pour ref. 7014



7015/1

ESP Recambios para borrador "Design"

Pack 5 uds. de fieltros para borrador ref. 7015.

ENG Refills for magnetic eraser "Design"

Pack of 5 refills for "Design" eraser ref. 7015.

FRA Feutrinnes remplacement pour "Design"

Böîte de 5 recharges feutrine brosse ref. 7015.



7006/1

*Excl ref. 7012 & 7006

ESP Recambio para borrador de aluminio

Bolsa de 20 uds. de fieltros para borrador.

ENG Aluminium eraser refills

20 felt refills pack for aluminium erasers.

FRA Feutrinnes remplacement pour effaceur

Jeu de 20 unités de feutrinnes pour effaceur.

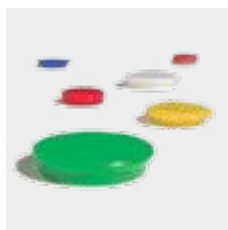

φ2 φ2.5 φ3.2

9002 - 9003 - 9004

ESP Imanes

Caja de 6 uds. de imanes redondos (2-2.5-3.2).

ENG Magnets

Pack of 6 circular magnets (2 - 2.5 - 3.2).

FRA Aimants

Böîte de 6 aimants ronds (2 - 2.5 - 3.2).



φ0.9

9010

*Kit 1 color

ESP Imanes

Caja de 20 uds. de imanes redondos.

ENG Magnets

Pack of 20 circular magnets.

FRA Aimants

Böîte de 20 aimants ronds.



9011

*Kit 1 color

ESP Imanes

20 uds. de imanes cuadrados (0.9 cm).

ENG Magnets

Pack of 20 square magnets (0.9 cm).

FRA Aimant

Böîte de 20 aimants carrés (0.9 cm).

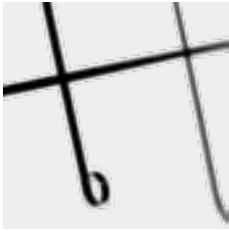

7011

- ESP Cintas adhesivas negras**
50 tiras adhesivas de 50 x 0,25 cm.
- ENG Black adhesive tapes**
50 adhesive strips 50 x 0,25 cm.
- FRA Films adhésifs noir**
50 bandes adhésives 50 x 0,25 cm.

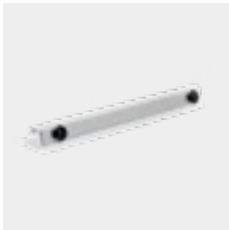
7002

- ESP Pinza portablocs**
Portablocs de papel. de 7 x 69 cm.
- ENG Pad holder**
7 x 69 cm. pad holder.
- FRA Pince papier**
Pince papier 7 x 69 cm.

7019

- ESP Portarrotuladores magnéticos**
Disponible para 4 rotuladores.
- ENG Magnetics marker holder**
Magnetic holder for 4 boards markers.
- FRA Porte marqueurs magnétique**
Disponible pour 4 marqueurs.

7008

- ESP Aerosol para pizarras**
Para limpieza de pizarras blancas 200ml.
- ENG Whiteboard cleaner spray**
For cleaning of white boards 200 ml.
- FRA Aerosol pour tableau**
Nettoyant aérosol 200 ml.

9012 - 9014

- ESP Banda magnética**
Tira magnética de 0,9x50 cm y 1,8x50 cm.
- ENG Magnetic strips**
Magnetic strip of 0,9x50cm. and 1,8x50cm.
- FRA Bande magnétique**
Bande magnetique de 0,9x50 et 1,8x50cm.

7005 - 7005/12

- ESP Rotuladores de pizarra**
Pack 4 rotuladores borrado en seco.
- ENG Whiteboard markers**
Pack 4 whiteboard markers.
- FRA Marqueurs effaçables à sec**
Bôte 4 marqueurs effaçables à sec.

7001

- ESP Bloc de papel liso**
Contiene 25 hojas de 90x 60 cm.
- ENG Pad of plain paper**
With 25 sheets 90 x 60 cm.
- FRA Recharge papier uni**
Bloc papier uni 25 feuilles 90 x 60 cm.



7002/M

- ESP Pinza portablocs magnética**
Pinza de 6x65cm. para sup. magnéticas.
- ENG Magnetic pad holder**
6 x 65 cm. long magnetic pad holder
- FRA Pince papier magnétique**
Pince fixe papier magnétique 6 x 65 cm.

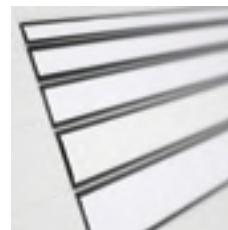

7003 - 7003/30 - 7003/50

- ESP Cajetín de aluminio**
Cajetín de aluminio de 100, 30 ó 50 cm.
- ENG Aluminium tray**
100, 30 or 50 cm. long aluminium pen tray.
- FRA Auget porte marqueurs**
Porte-marqueurs de 100, 30 ou 50cm.

5 1,5 2,5 3 4

9005 - 9006 - 9007 - 9008 - 9009

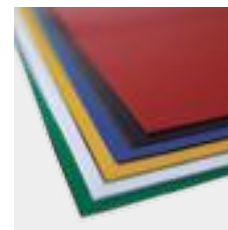
- ESP Portarrótulos magnético**
Portarrótulos de 50 cm. de largo.
- ENG Magnetic title holder**
50 cm. long magnetic title holder.
- FRA Porte-étiquettes magnétiques**
Porte-étiquettes 50 cm.

9000

- ESP Placa magnética**
Placa de 50 x 60 cm.
- ENG Magnetic plaque**
Plaque 50 x 60 cm.
- FRA Plaque magnétique**
Plaque 50 x 60 cm.



Más accesorios pág. 47 / More accesories 47/ Plus accès pag. 47



BASIC

PIZARRA DE **MARCO PINO**
PINE FRAME WHITEBOARD
 TABLEAU **CADRE EN PIN**



REF	L	H	uts./ box
BL/VI/7271	30 x 40	1,4	40
BL/VI/7272	40 x 60	1,4	20
BL/VI/7273	60 x 90	1,4	10
BL/VI/7274	90 x 120	1,4	6

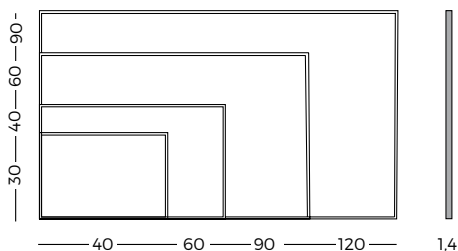

PIZARRA

ESP Pizarra blanca plastificada y rotulable enmarcada con marco pino natural. Disponible en 4 medidas. Incluyen 1 rotulador con portarrotulador adhesivo y herrajes para sujeción.

WHITEBOARD

ENG Plastic whiteboard with a wooden frame. Available in 4 sizes. Including a pen tray holder and its pen to write plus the screws.

TABLEAU

FRA Tableau blanc en plastique pour feutres avec cadre en pin naturel. Disponible en 4 dimensions. Inclus 1 stylo et son auget porte feutre adhésif.



KITS DE ACCESORIOS



KIT ECO

REF	CONTIENE
KIT/E	4 Rotuladores Líquido limpiador 50ml. Borrador magnético OVAL Filtros recambio borrador Pack 10 imanes ø20mm.



KIT TOP

REF	CONTIENE
KIT/T	4 Rotuladores Líquido limpiador 200 ml. Borrador magnético Filtros recambio borrador Pack 10 imanes ø20 mm. Reposa-rotuladores magnético



PS CAPTURE

REF	uts/ box	L
PS/C	4 + 1 sticker	10 x 10



Más información pág. 12 / More info pag. 12 / Plus information pag. 12

PS CAPTURE

ESP Marcadores magnéticos de alta calidad disponibles para la compra directa.

PS CAPTURE

ENG High quality magnetic markers available for direct sale.

PS CAPTURE

FRA Marqueurs magnétiques de grande qualité disponible en achat direct.

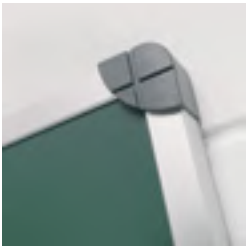

02

ESCOLPLAN

**EQUIPAMIENTO ESCOLAR
SCHOOL EQUIPEMENT
EQUIPEMENT SCOLAIRE**



SUPERFICIES PS

SUPERFICIES DE ESCRITURA
WRITTING SURFACES
SURFACE D'ÉCRITURE

ESP Descripción, características y cualificación según calidad de las diferentes superficies de escritura en los productos Escolplan. Incluye características de una pared cubierta con pintura de pizarra o superficies en diferentes materiales y colores.

ENG Description, characteristics and uses according to the quality of the writing surface in the Escolplan product range. Includes features such as wall covered slate paint or surfaces in different materials and colors.

FRA Description, caractéristiques et qualification selon la qualité des différentes superficies d'écriture des produits Escolplan. Inclus les caractéristiques d'un mur couvert de peinture tableau ou des superficies de différents matériaux.

COLORES

COLORES
 COLOURS
 COULEURS

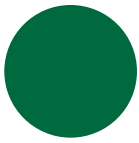

RAL 6028

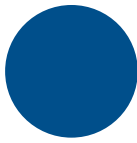

RAL 5023



RAL 7015



RAL 7012

01

PINTURA PS
PS PAINT
PEINTURE PS

PNT/TZ



04

SUPERFICIE LAMINADA
LAMINATED SURFACE
SURFACE STRATIFIÉE

730 - ZENIT - 730/X



COLORES

ESP Colores disponibles para pizarras Escolplan de Planning Sisplamo. Ideal para la escritura en tizas de colores o rotuladores de tiza líquida.

ENG Colours available colors for Escolplan plan boards of Planning Sisplamo. Ideal for writing with colored chalks or liquid chalk markers.

FRA Couleurs disponibles pour tableaux Escolplan de Planning Sisplamo. Idéal pour l'écriture à la craie de couleurs ou feutre de craie liquide.



CAPA DE PINTURA

ESP Pintura de pared para convertir cualquier superficie en una pizarra. Rotulable con rotuladores de borrado en seco. Disponible en diferentes colores. Más colores disponibles bajo pedido.

ENG Wall paint to turn any surface into a blackboard. Can be marked with erasers in dry conditions. Available in different colours. More colours available on request.

FRA Peinture murale pour convertir n'importe quelle superficie en tableau. Fonctionne avec craie et feutre de craie liquide. Disponible en plusieurs couleurs.



SUPERFICIE LAMINADA



ESP Superficie de escritura de color en plancha laminada de alta presión (HPL). Extremadamente resistente a impactos y al desgaste. Fácil mantenimiento. No magnética.

ENG Color writing surface in high pressure laminated board (HPL). Extremely resistant to impacts and wear. Easy maintenance. Not magnetic.

FRA Superficie d'écriture de couleur en planche laminée à haute pression (HPL). Extrêmement résistante aux impacts et usure. Facile d'entretien. Non magnétique.

PERFILES Y CANTONERAS PROFILES AND ANGLES PROFILÉS ET COINS

ESP Los perfiles que enmarcan las pizarras de Planning Sisplamo son de aluminio anodizado. Las cantoneras, que ocultan el tornillo, son piezas fabricadas por inyección de ABS.

ENG The profiles framing Planning Sisplamo white boards are anodized aluminum. The corners, which conceal the screw, are manufactured by injection of ABS.

FRA Les profiles qui encadrent les tableaux Planning Sisplamo sont en aluminum anodisé. Les coins, qui cachent la fixation, sont des pièces fabriqués par injection d'ABS.



05 ACERO VITRIFICADO ENAMELLED SURFACE SURFACE ÉMAILLÉE

730/A - 730/C - 730/P - 734 - ZENIT - 730/D - 730/T - 730/A/X - 739 - 730/VV - 730/G

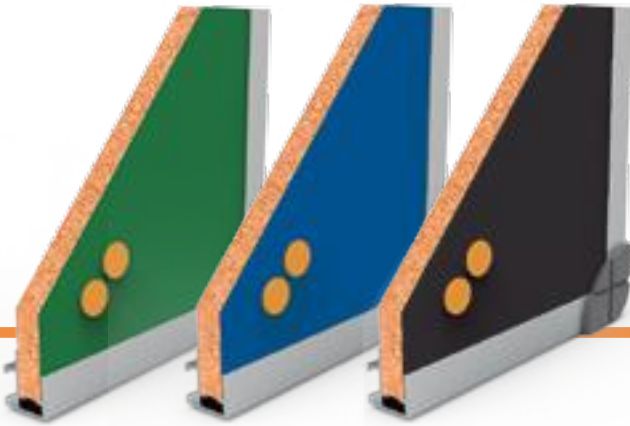

La superficie e³ CeramicSteel es la única del sector a nivel mundial con la certificación:

Cradle to Cradle Certified™ Bronze

Norma ISO 9001



ACERO VITRIFICADO



ESP Superficie de color en acero vitrificado formada por una lámina central de acero de 0,7 mm cubierta con un revestimiento delgado de esmalte, que se funde con el acero a 800°C. Fabricado con un 30% de acero reciclado. Reciclable al 99,9%. Se puede escribir con marcadores de borrado en seco, semipermanentes, solubles en agua o permeantes sin dañarla. Garantía de por vida. Resistente a rayaduras, abrasión, productos químicos, fuego, bacterias y graffitis. Fácil mantenimiento. Mayor contraste de color. Visibilidad mejorada y óptima comodidad visual. Magnética.

ENG Coloured surface in vitrified steel formed by a 0.7 mm steel core sheet covered with a thin coating of enamel, which melts with the steel at 800 ° C. Made with 30% recycled steel. Recyclable at 99.9%. It can be written on with dry erase markers, semipermanent, water soluble or permeant without damaging it. Lifetime warranty. Resistant to scratches, abrasion, chemicals, fire, bacteria and graffiti. Easy maintenance. Higher color contrast. Improved visibility and optimum visual comfort. Magnetic.

FRA Superficie de couleur en acier vitrifié formé par une tôle d'acier de 0,7mm recouverte d'un revêtement émaillé fondu à 800°C. Fabriqué avec 30% d'acier recyclé. Recyclable à 99,9%. Peuvent s'utiliser des craies et autres marqueurs à craie liquide sans l'abîmer. Garantie à vie. Résistant aux rayures, abrasion, produits chimiques, feu, bactéries et graffitis. Facile d'entretien. Grand contraste de couleur. Visibilité améliorée et qualité visuel optimum. Magnétique.



GUÍA PS

ESCOGE TU **PIZARRA**
CHOOSE YOUR **WHITEBOARD**
CHOISIR VOTRE **TABLEAU**

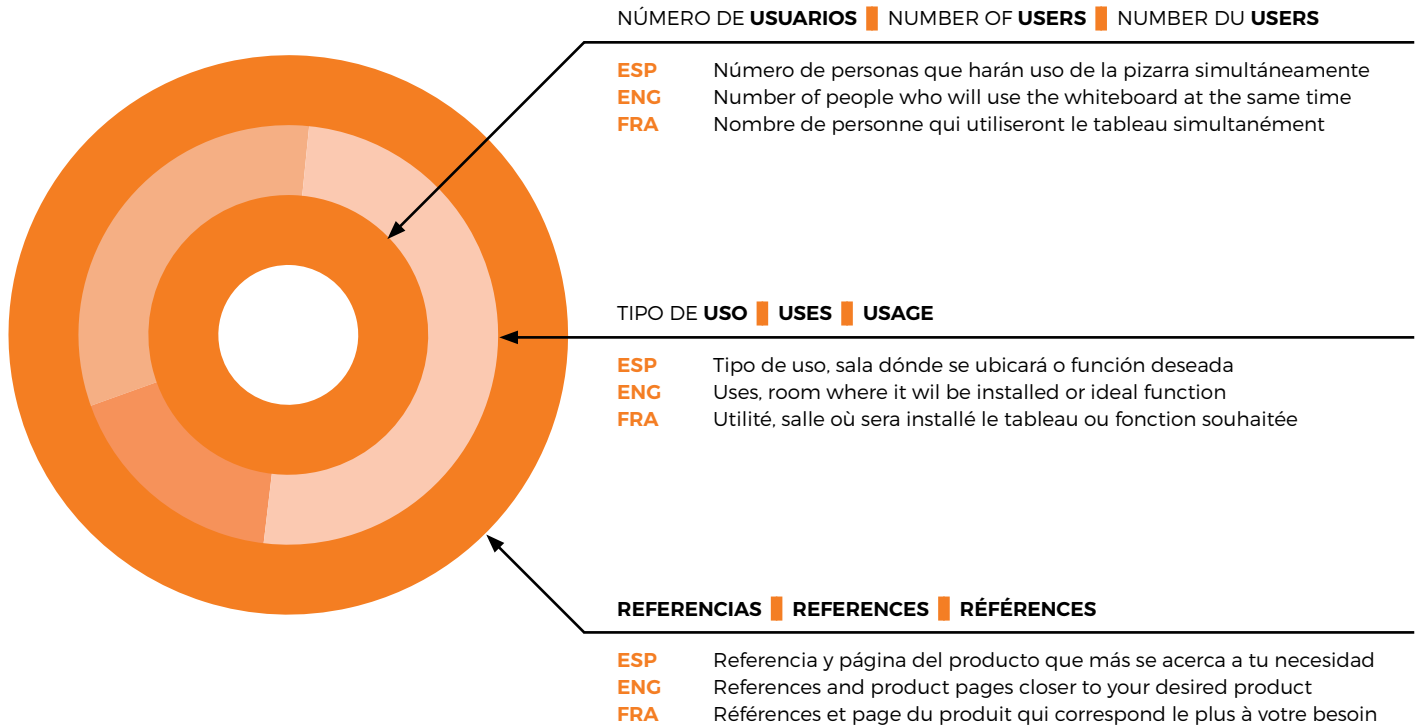

PERSONAL

PERSONAL | PERSONALE

ESP Pizarras de uso personal para el uso en el hogar o en salas de pequeñas dimensiones. Disponibles en versión mural, con soportes, en diferentes materiales y colores.
MMR: 40 x 60 cm.

ENG Whiteboards for use in the home or in small rooms. Available in mural version, with supports, in varied materials and many colors.
MMR: 40 x 60 cm.

FRA Tableau à usage personnel pour la maison ou de petites pièces/bureaux.. Disponible en version murale, avec support et en différents matériaux et couleurs.
MMR: 40 x 60 cm

ESCUELA

SCHOOL | ÉCOLE

ESP Pizarras para uso en escuelas, universidades o centros de enseñanza, con una altura de 120 cm y longitud variable. Se recomienda el uso de este tipo de pizarras debido a su medida ergonómica: tanto el punto superior como inferior coinciden con el punto de máxima extensión del brazo. Disponibles en versión mural, con soportes, en diferentes materiales y colores.
MMR: 120 x 150 cm.

ENG White boards for use in schools, universities or teaching, with a height of 120 cm and variable length. The use of this type of board is recommended due to its ergonomic measurement: both the upper and lower points coincide with the point of maximum extension of the arm. Available in mural version, with supports, in different materials and colours.
MMR: 120 x 150 cm.

FRA Tableaux pour usage en écoles, universités ou centres d'enseignement, avec une hauteur de 120 cm et longueur variable. Il est recommandé l'usage de ce type de tableaux pour leur dimensions ergonomiques: le point supérieur et inférieur coïncide avec le point maximum d'extension du bras. Disponibles en version murale, avec supports, en différents matériaux et couleurs.
MMR: 120 x 150 cm.

***MMR**

Medida Mínima Recomendada | Recommended Minimum Size | Dimension Minimum Recommandée

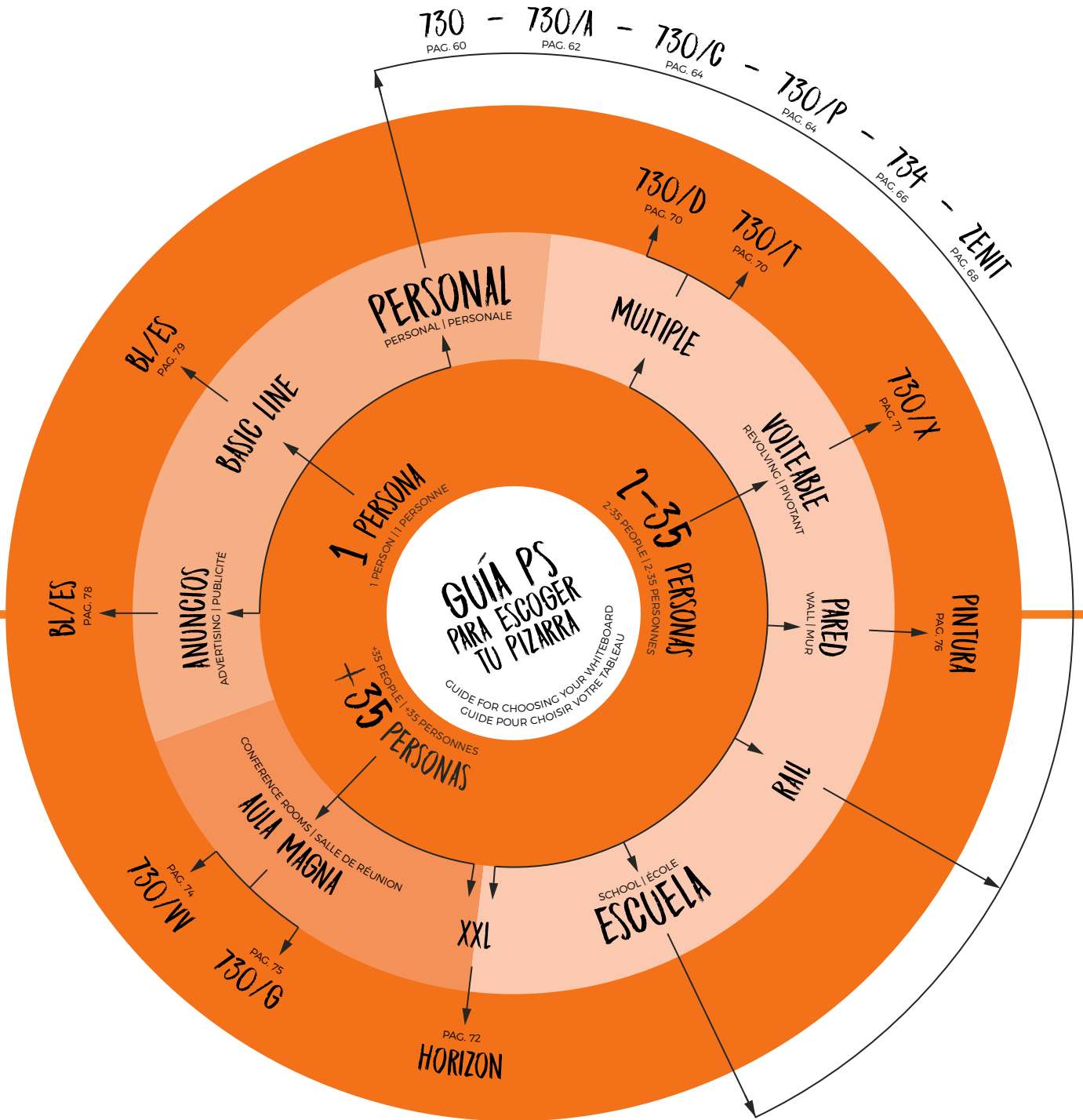

* 730 - 730/A - 730/C - 730/P - 734 - ZENIT

Diferentes medidas según uso o ubicación. ■ Diferentes sizes for different uses or locations. ■ Différentes mesures selon usage et emplacement.



730

PIZARRA LAMINADA
LAMINATED CHALK BOARD
TABLEAU STRATIFIÉ



REF	L	H	RAIL	
730/11	40 x 60	2.2	30	-
730/12	60 x 80	2.2	30	-
730/1	80 x 120	2.2	30	✓
730/2	100 x 120	2.2	30	✓
730/3	120 x 150	2.2	30	✓
730/4	120 x 200	2.2	30	-
730/5	120 x 250	2.2	30	-
730/6	120 x 300	2.2	30	-
• 730/7	120 x 350	2.2	30	-
• 730/8	120 x 400	2.2	30	-
• 730/9	120 x 500	2.2	30	-
• 730/10	120 x 600	2.2	30	-

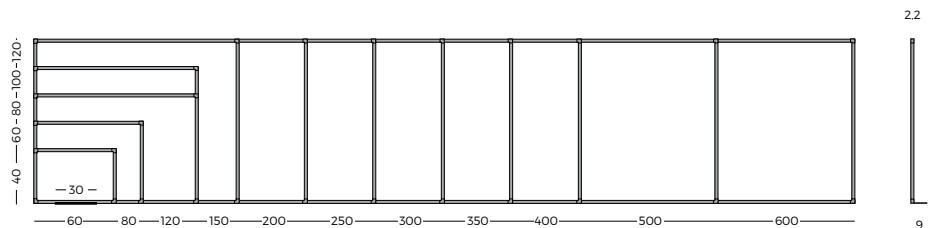

*Fabricada en dos piezas / Made in two pieces

PIZARRA LAMINADA

ESP Pizarra mural verde enmarcada con perfil de aluminio anodizado en color plata mate y cantoneras redondeadas de plástico gris. Superficie laminada de alta presión para escritura con tiza. Incluye cajetín reposatizas de 30 cm.

LAMINATED CHALK BOARD

ENG Chalk board equipped with silver anodised aluminium frame and plastic rounded corners. High pressure laminated surface. A 30 cm. Pen tray included.

TABLEAU STRATIFIÉ

FRA Tableau vert avec encadrement aluminium anodisé argent et coins arrondis en plastique. Surface laminée à haute pression pour écriture à la craie. Livré avec auget porte-marqueurs 30 cm.



SOPORTE T

REF	↑	└	┆┆	□
736/L	190	120 x 150	53	30
737/L	190	120 x 200	53	30



SOPORTE DELTA

REF	↑	└	┆┆	□
738/L	190	120 x 150	53	30
739/L	190	120 x 200	53	30



SOPORTE Y2

REF	↑	└	┆┆	□
730/2 + Y2/120	190	100 x 120	53	30
730/3 + Y2/150	190	120 x 150	53	30
730/4 + Y2/200	190	120 x 200	53	30

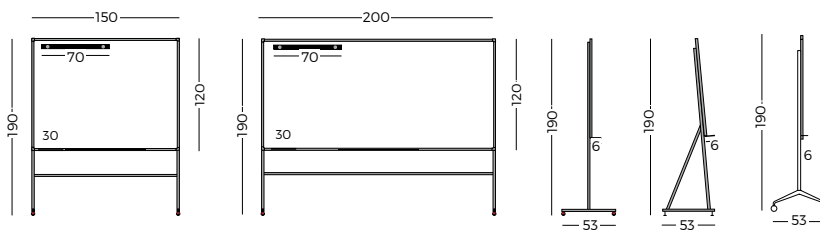

PS CAPTURE

App by Planning Sisplamo
planningsisplamo.com/pscapture



ACCESORIOS

REF: 7012

REF: 7014

REF: 7013/B

REF: 7014/1





730/A

PIZARRA DE ACERO VITRIFICADO
ENAMELLED CHALK BOARD
 TABLEAU EMAILLÉ

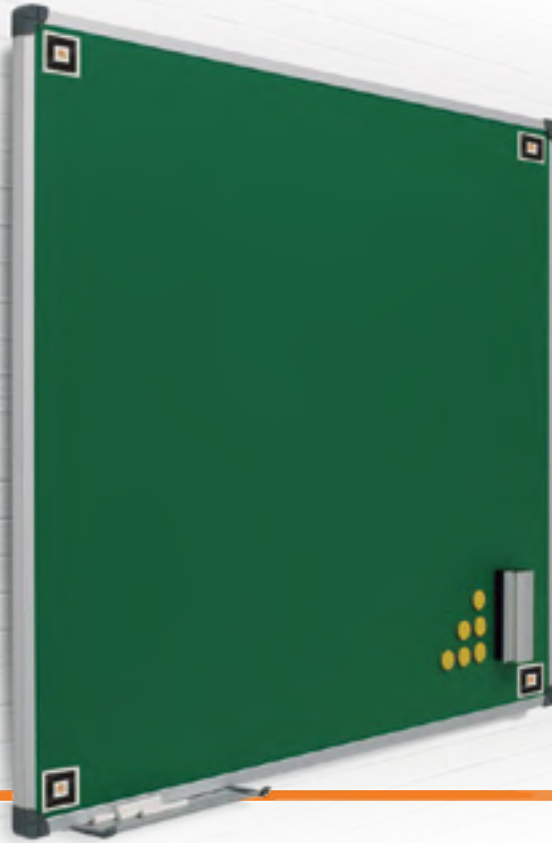
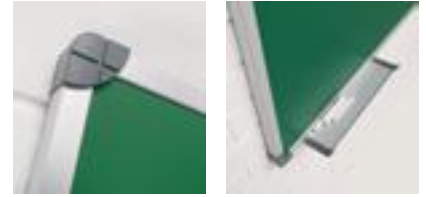

COLOR PIZARRA



REF	L	H	RAIL	RAIL
730/A1	120 x 100	2.2	30	✓
730/A2	120 x 150	2.2	30	✓
730/A3	120 x 200	2.2	30	-
730/A4	120 x 250	2.2	30	-
730/A5	120 x 300	2.2	30	-
730/A6	120 x 400	2.2	30	-

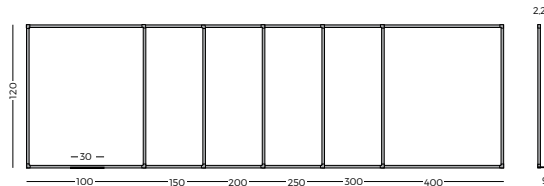

PIZARRA ACERO VITRIFICADO

ESP Pizarra mural verde enmarcada con perfil de aluminio anodizado en color plata mate y cantoneras redondeadas de plástico gris. Superficie magnética de acero vitrificado a 800°C para escritura con tiza. Incluye cajetín de 30 cm. Fabricadas en una pieza.

CHALK BOARD

ENG Chalk board equipped with silver anodised aluminium frame and plastic rounded corners. Magnetic 800°C enamelled steel surface, green for chalk. A 30 cm. pen tray is included. Manufactured in one piece.

ACIER ÉMAILLÉ

FRA Tableau vert en acier émaillé à 800 °C avec encadrement aluminium anodisé couleur argent et coins arrondis en plastique. Surface magnétique émaillée vitrifiée à 800° C pour écriture à la craie. Livré avec auget porte-marqueurs de 30 cm. Fabriqué d'une pièce.



SOPORTE T

REF	↑	↳	⇄	☐
736/A	190	120 x 150	53	30
737/A	190	120 x 200	53	30



SOPORTE DELTA

REF	↑	↳	⇄	☐
738/A	190	120 x 150	53	30
739/A	190	120 x 200	53	30



SOPORTE Y2

REF	↑	↳	⇄	☐
730/A1 + Y2/120	190	100 x 120	53	30
730/A2 + Y2/150	190	120 x 150	53	30
730/A3 + Y2/200	190	120 x 200	53	30

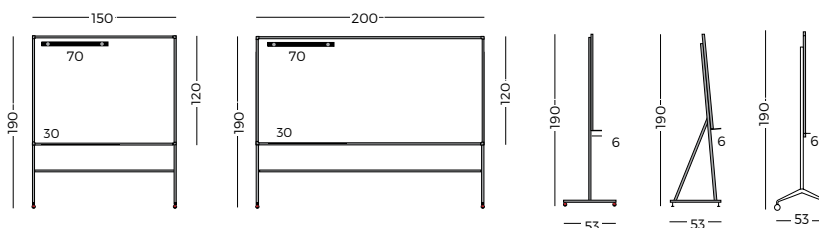

PS CAPTURE

App by Planning Sisplamo
planningsisplamo.com/pscapture

ACCESORIOS

REF: 7006



REF: 7013/B



REF: 7013/C



REF: 9002





730/C-730/P

CUADRÍCULA / PENTAGRAMA
 GRIDDED / PENTAGRAM
 QUADRILLÉ / PENTAGRAMME

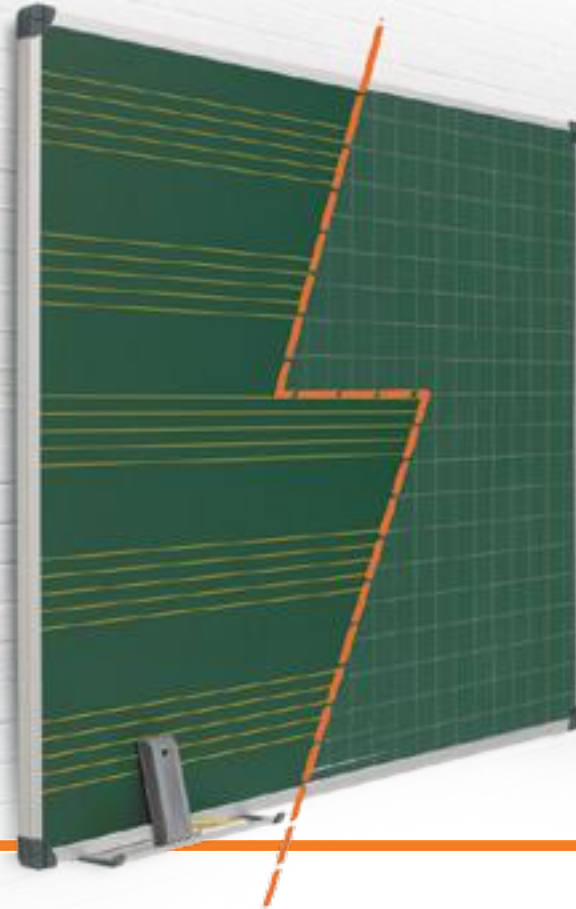

REF	L	H	RAIL
730/A/C1	100 x 120	2.2	30 ✓
730/A/C2	120 x 150	2.2	30 ✓
730/A/C3	120 x 200	2.2	30 -
730/A/C4	120 x 300	2.2	30 -

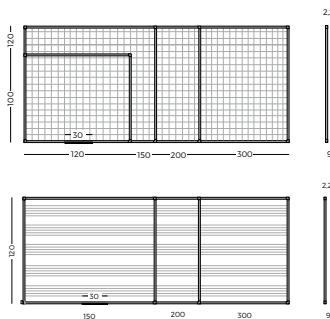
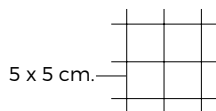

REF	L	H	RAIL
730/A/P1	120 x 150	2.2	30 ✓
730/A/P2	120 x 200	2.2	30 -
730/A/P3	120 x 300	2.2	30 -

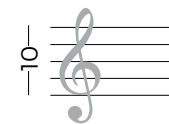

PIZARRA

ESP Pizarra verde con cuadrícula/pentagrama enmarcada con perfil de aluminio anodizado en color plata mate y cantoneras redondeadas de plástico gris. Superficie para escritura con tiza. Incluye cajetín reposatizas de 30 cm. 5 pentagramas en color amarillo y/o cuadrícula de 5 x 5 cm.

CHALK BOARD

ENG Gridded / pentagram chalk board equipped with silver anodised aluminium frame and plastic rounded corners. A 30 cm. pen tray included. 5 yellow pentagrams and/or 5 x 5 cm. gridded.

TABLEAU

FRA Tableau pentagramme vert avec encadrement aluminium anodisé couleur argent et coins arrondis en plastic. Surface pour écriture à la craie. Livré avec auget porte-marqueurs 30 cm. 5 pentagrammes de couleur jaune et/ou quadrillé de 5 x 5 cm.



SOPORTE T

REF	↑	↳	⇄	☐
730/AC/T2	190	120 x 150	53	30
730/AC/T3	190	120 x 200	53	30
736/A/P2	190	120 x 150	53	30
737/A/P3	190	120 x 200	53	30



SOPORTE DELTA

REF	↑	↳	⇄	☐
730/AC/D2	190	120 x 150	53	30
730/AC/D3	190	120 x 200	53	30
738/A/P2	190	120 x 150	53	30
739/A/P3	190	120 x 200	53	30



SOPORTE Y2

REF	↑	↳	⇄	☐
730/A/C2 + Y2/150	190	120 x 150	53	30
730/A/C3 + Y2/200	190	120 x 200	53	30
730/A/P1 + Y2/150	190	120 x 150	53	30
730/A/P2 + Y2/200	190	120 x 200	53	30

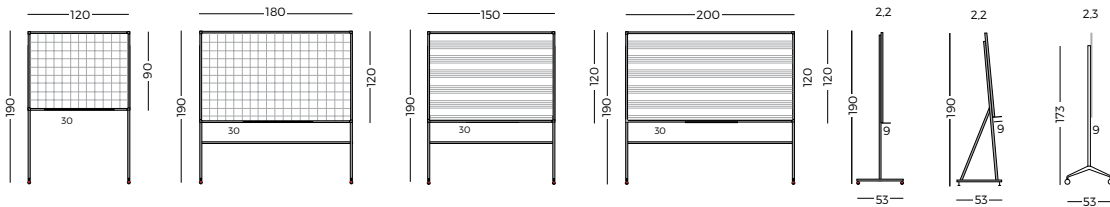

ACCESORIOS

REF: 7006



REF: 9002



REF: 7014



REF: 7013/B



REF: 7013/C



REF: 7014/I





PS CAPTURE

App by Planning Sisplamo
planningsisplamo.com/pscapture





734

PIZARRA MARCO "MINI"
CHALK BOARD "MINI"
TABLEAU "MINI"

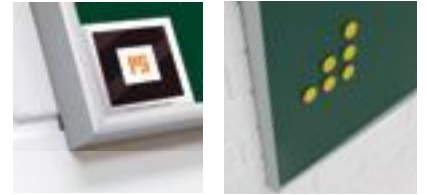

COLOR PIZARRA



REF	L	H	RAIL
734/10	40 x 60	2.3	30 -
734/1	60 x 80	2.3	30 -
734/2	80 x 100	2.3	30 ✓
734/3	100 x 120	2.3	30 ✓
734/4	120 x 150	2.3	30 ✓
734/5	120 x 200	2.3	30 -
734/6	120 x 250	2.3	30 -

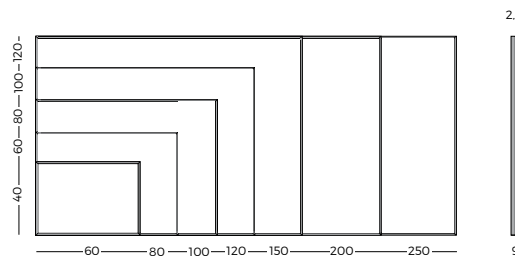

PIZARRA A.V. "MINI"

ESP Pizarra mural verde enmarcada con perfil de aluminio anodizado en color plata mate marco mini a inglete. Superficie magnética de acero vitrificado a 800° C con garantía de por vida. Incluye cajetín reposatizas.

CHALK BOARD E. "MINI"

ENG Enamelled steel chalkboard with anodized aluminium "mini" mitred frame. Magnetic surface cooked at 800°C. Lifetime guaranteed. Delivered with marker-holder.

TABLEAU E. "MINI"

FRA Tableau vert en acier émaillé avec cadre "mini" en aluminium anodisé à angles droits. Surface magnétique vitrifiée, cuite à 800°C. Garantie à vie. Livré avec auget portemarqueurs.



SOPORTE T

REF	↑	↳	⇄	☐
734/T2	190	100 x 80	53	30
734/T3	190	100 x 120	53	30
734/T4	190	120 x 150	53	30
734/T5	190	120 x 200	53	30



SOPORTE DELTA

REF	↑	↳	⇄	☐
734/D2	190	100 x 80	53	30
734/D3	190	100 x 120	53	30
734/D4	190	120 x 150	53	30
734/D5	190	120 x 200	53	30



SOPORTE Y2

REF	↑	↳	⇄	☐
734/2 + Y2/80	190	100 x 80	53	30
734/3 + Y2/120	190	100 x 120	53	30
734/4 + Y2/150	190	120 x 150	53	30
734/5 + Y2/200	190	120 x 200	53	30

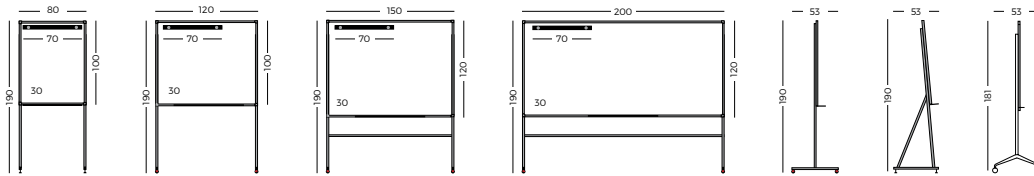

PS CAPTURE

App by Planning Sisplamo
planningsisplamo.com/pscapture



ACCESORIOS

REF: 7015

REF: 7013/B

REF: 7013/C

REF: 7014





ZENIT

PIZARRA "ZENIT"
CHALKBOARD "ZENIT"
TABLEAU "ZENIT"

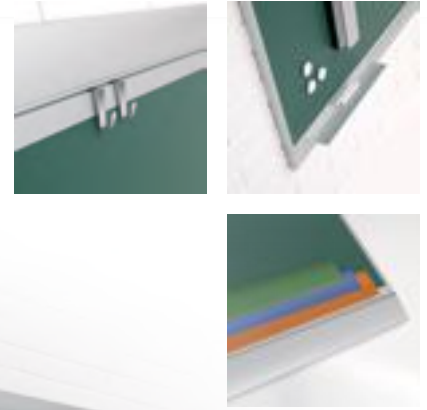

PERFIL LACADO



* /NG /BL /AM /RJ /AZ /VD /NJ

COLOR PIZARRA



/VD /AZ /NG /GR

REF	L	H	RAIL	RAIL
Z/730/A0	80 x 100	2.3	30	✓
Z/730/A1	100 x 120	2.3	30	✓
Z/730/A2	120 x 150	2.3	30	✓
Z/730/A3	120 x 200	2.3	30	-
Z/730/A4	120 x 250	2.3	30	-
Z/730/A5	120 x 300	2.3	30	-

REF	L	H	RAIL	RAIL
Z/730/0	80 x 120	2.3	30	-
Z/730/1	100 x 150	2.3	30	-
Z/730/2	120 x 150	2.3	30	-
Z/730/3	120 x 200	2.3	30	-
Z/730/4	120 x 250	2.3	30	-
Z/730/5	120 x 300	2.3	30	-

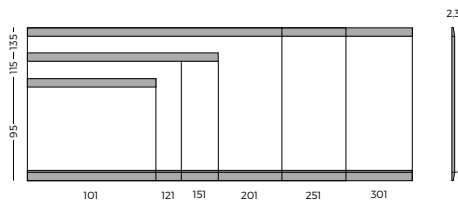

PIZARRA VERDE "ZENIT"

ESP Pizarra verde Zénit enmarcada con perfil de aluminio anodizado en color plata (tapa personalizable). Superficie laminada / acero vitrificado (800°C) verde brillo. Incluye una bandeja reposatizas de 30 cm.

CHALK BOARD "ZENIT"

ENG Vitrified chalkboard cooked at 800°C with anodized aluminium frame (customizable). Lifetime guaranteed, magnetic surface for chalk writing. Delivered with a 30 cm marker-holder. Colours green, blue, black and grey.

TABLEAU VERT "ZENIT"

FRA Tableau Zénit vert avec cadre en aluminium anodisé couleur argent (carters personnalisable). Surface verte stratifié / acier émaillé (800°C) et brillante. Inclus un auget pour craies de 30 cm.

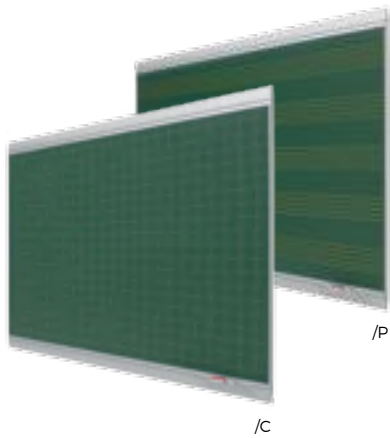

/C - /P

REF	└┐	┌┐	┌┐
/C			
Z/730/A/C1	100 x 120	2.3	30
Z/730/A/C2	120 x 150	2.3	30
Z/730/A/C3	120 x 200	2.3	30
/P			
Z/730/A/C4	120 x 300	2.3	30
Z/730/A/P1	120 x 150	2.3	30
Z/730/A/P2	120 x 200	2.3	30
Z/730/A/P3	120 x 300	2.3	30



SOPORTE Y2

REF	┆	└┐	┌┐	┌┐
Z/730/A/Y0	181	100 x 80	53	30
Z/730/A/Y1	181	100 x 120	53	30
Z/730/A/Y2	181	120 x 150	53	30
Z/730/A/Y3	181	120 x 200	53	30



SOPORTE Y2

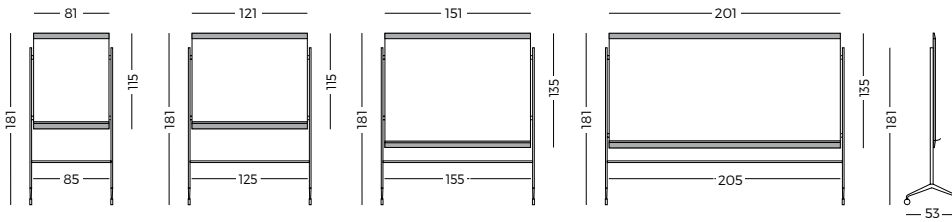

PIZARRA CUADRICULA & PENTAGRAMA

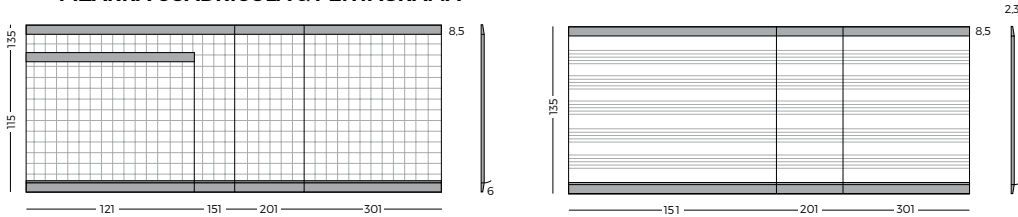

1 x 1 cm.
5 x 5 cm.

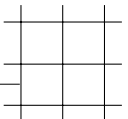

ACCESORIOS

REF: 7015

REF: 7013/B

REF: 7013/C

REF: Z/7003

REF: Z/7017





730/D-T

MURAL DÍPTICA / TRÍPTICA
 DOUBLE / TRIPLE PANELLERD
 TABLEAU DIPTYQUE / TRIPTYQUE



REF				
730/D1	90 x 120	90 x 60	2 + 4	30
730/D2	120 x 180	120 x 90	2 + 4	30

REF				
730/T1	90 x 240	90 x 120	2 + 4	30
730/T2	120 x 400	120 x 200	2 + 4	30

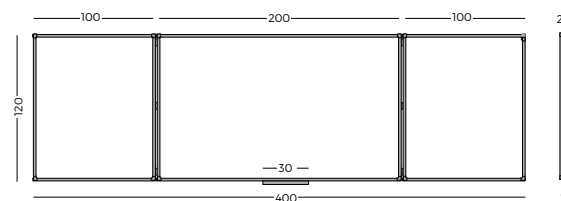
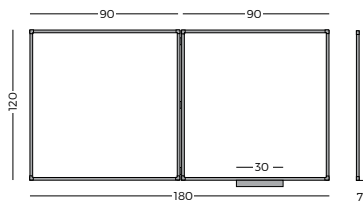

PIZARRA

CHALK BOARD

TABLEAU

ESP Pizarra mural díptica o tríptica verde de acero vitrificado enmarcada con perfil de aluminio anodizado en color plata mate y cantoneras redondeadas de plástico gris. Posee 3 ó 5 superficies de escritura respectivamente de cada pizarra con tiza. Incluye cajetín repositizas de 30 cm.

ENG Double or triple panelled chalk board enamelled steel surface equipped with silver anodised aluminium frame and plastic rounded corners. The double panel allows for 3 or 5 respectively separate writing surfaces. A 30 cm. chalk tray is included.

FRA Tableau diptyque ou triptyque vert en acier émaillé avec encadrement en aluminium anodisé couleur argent et coins arrondis en plastic. Panneau double pour écriture à la craie sur les 3 ou 5 surfaces respectivement. Livré avec un auget porte-craies de 30 cm.

**PIZARRA VOLTEABLE
REVOLVING CHALK BOARD
TABLEAU PIVOTANT**

730/X



REF	↑	L	⇄	□
730/A/X1	210	120 x 150	53	100
730/A/X2	210	120 x 175	53	100
730/A/X3	210	120 x 200	53	100

REF	↑	L	⇄	□
730/X1	210	120 x 150	53	100
730/X2	210	120 x 175	53	100
730/X3	210	120 x 200	53	100

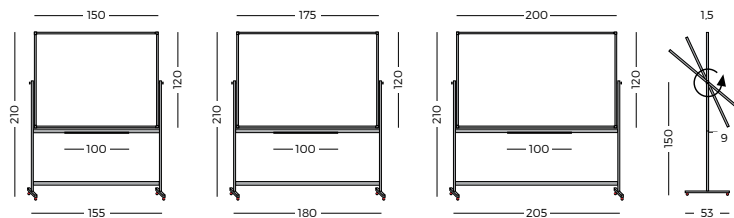
PIZARRA

ESP Pizarra verde volteable doble cara enmarcada con perfil de aluminio anodizado en color plata mate y cantoneras redondeadas de plástico gris. Superficie doble para escritura con tiza. Estructura metálica móvil provista de 4 ruedas (2 de ellas con freno).

CHALK BOARD

ENG Revolving chalk board equipped with silver anodised aluminium frame and plastic rounded corners. Double side surface. Metallic mobile support equipped with 4 castors (2 with brakes).

TABLEAU

FRA Tableau rotatif vert avec encadrement en aluminium anodisé couleur argent et coins arrondis en plastique. Monté sur piétement double. Double surface pour écriture pour la craie. Support métallique mobile équipé de 4 roulettes (dont 2 à frein).

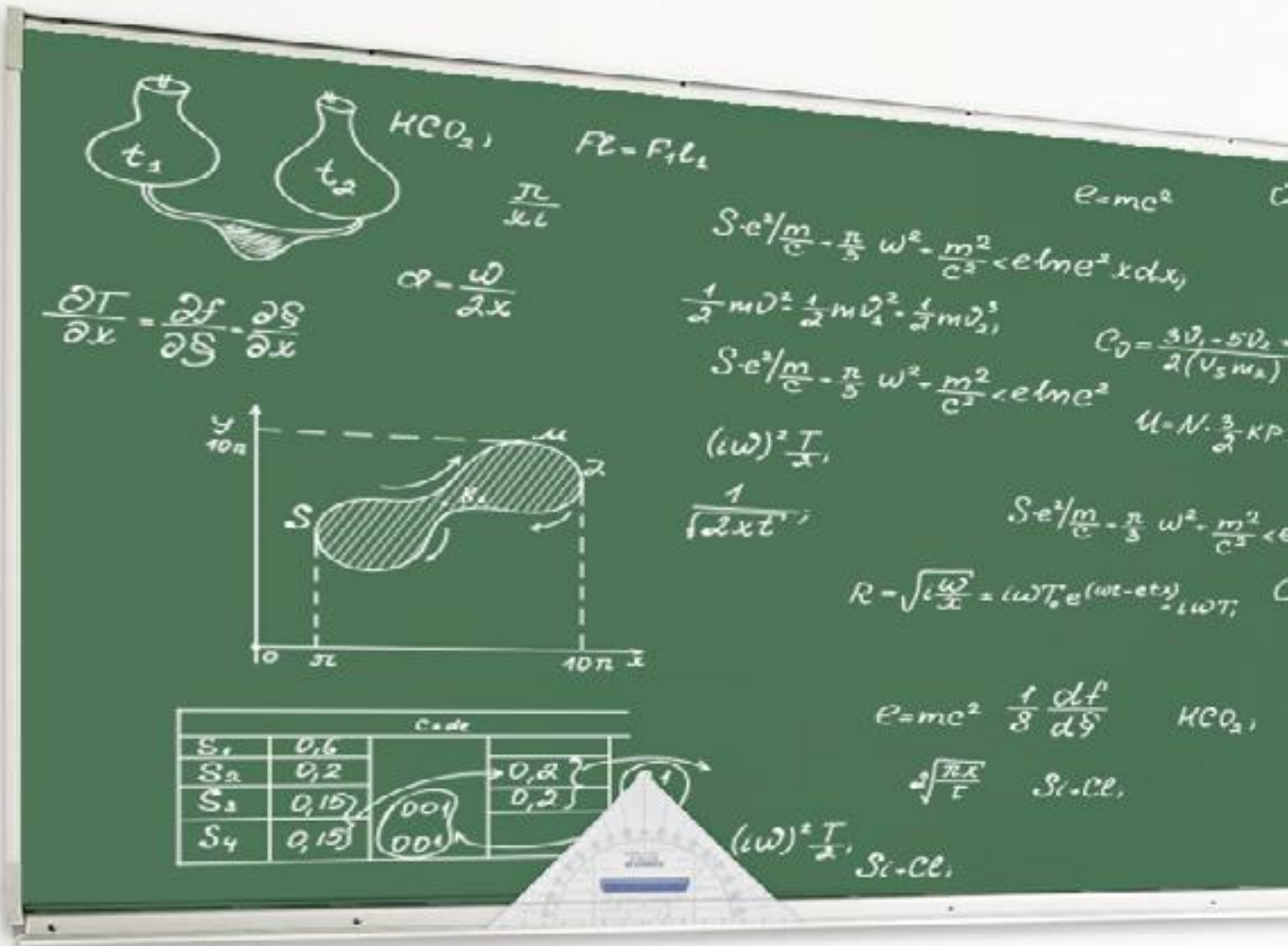

COLOR PIZARRA



REF L H W

- * 730/H4 120 x 400 9 400
- * 730/H5 120 x 500 9 500
- * 730/H6 120 x 600 9 600
- * 730/H8 120 x 800 9 800



*En 2 piezas / 2 pieces / En 2 parties

PIZARRA HORIZON

ESP Pizarra mural verde vitrificada de hasta 8 metros de longitud. Superficie magnética rotulable en seco de acero vitrificado a 800°C con garantía de por vida. Todas las pizarras se fabrican en 2 piezas. Incluye gancho porta planos.

HORIZON CHALKBOARD

ENG Framed chalkboard with anodized aluminum profile up to 8 meters in length. Magnetic surface can be labeled dry in vitrified steel at 800°C with lifetime warranty. All boards are made in 2 pieces. Map's hook included.

TABLEAU HORIZON

FRA Tableau mural vert jusqu'à 8 mètres de long. Superficie magnétique pour marqueurs effaçable à sec en acier émaillé 800°C garantie à vie. Ce tableau est en deux parties. Inclus deux crochets pour plans.

PIZARRA GRAN FORMATO
CHALKBOARD BIG SIZE
TABLEAU CONFÉRENCE

HORIZON

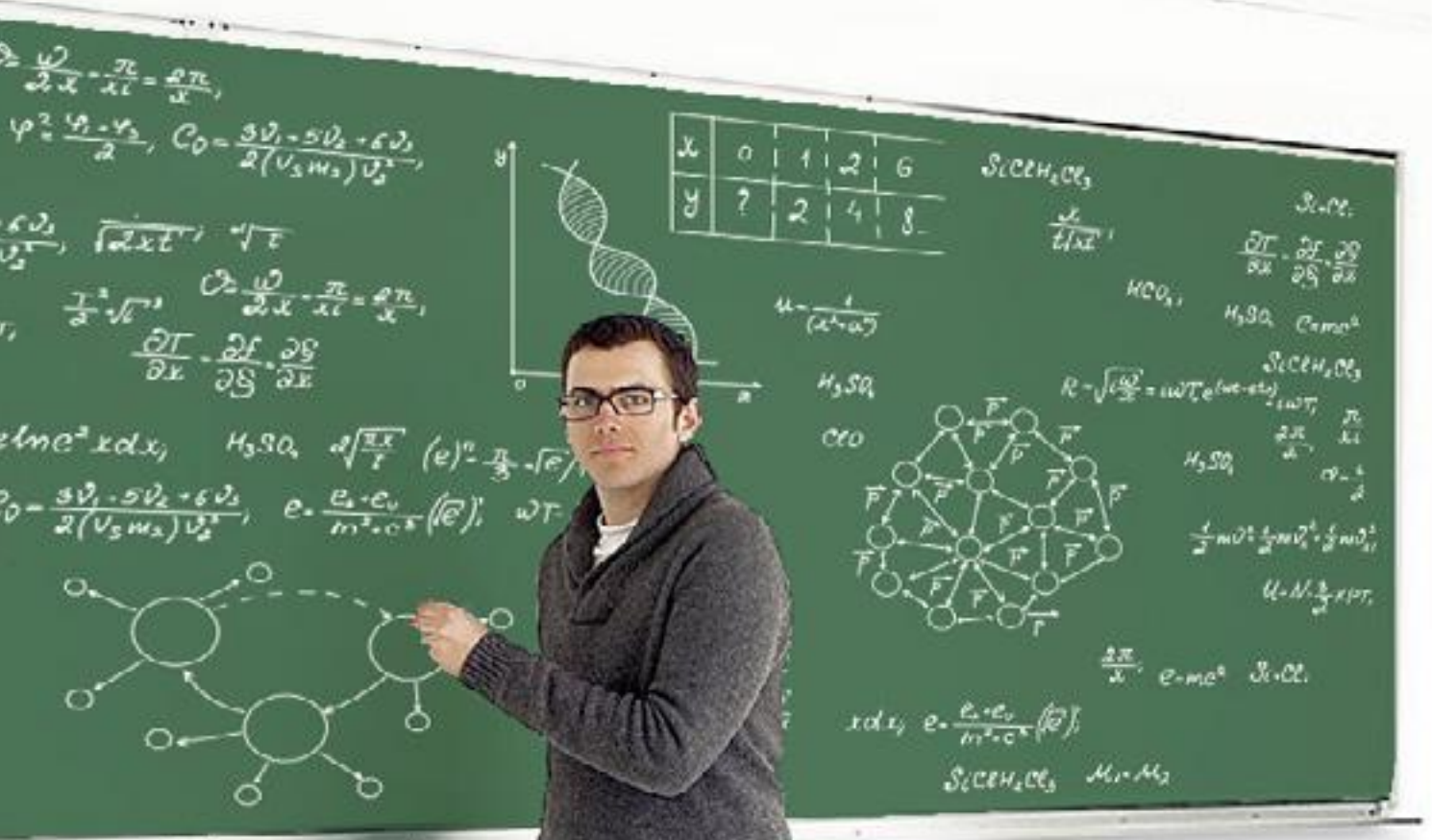



730/W

PIZARRA DE VAIVÉN
BOARD VAIVÉN
TABLEAU VA-ET-VIENT

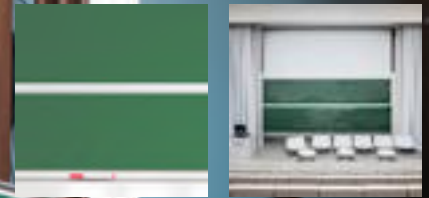

COLOR PIZARRA



REF		L	H
730/2/VV1	x	120 x 200	12
730/2/VV2	x	120 x 250	12
730/2/VV3	x	120 x 300	12
730/2/VV4	x	120 x 400	12

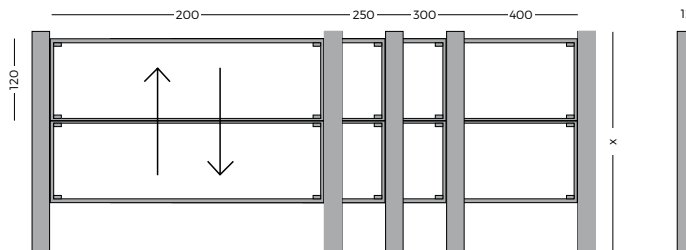

PIZARRA VAIVEN

ESP Pizarra blanca de acero vitrificado sobre una estructura de aluminio anodizado en plata mate montada sobre suelo y pared. La pizarra se desliza y va guiada en el perfil por rodamientos de nylon. Ideales para colegios, universidades, anfiteatros...

CHALK BOARD VAIVEN

ENG Enamelled whiteboard mounted upon a supporting structure in silver anodised aluminium on stand or wall fixation. The surface slide is guided through a cable transmission. The ideal communication tool for large scale presentations, lecture theatres...

TABLEAU VA-ET-VIENT

FRA Tableau blanc émaillé monté sur une structure en aluminium anodisé couleur argent, fixation sol et mur. La surface se déplace sur le profil via des roulements. Pour une communication idéale dans les amphithéâtres, salles de congrès...



PIZARRA DE GUILLOTINA
SASH BOARD
TABLEAU GUILLOTINE

730/G

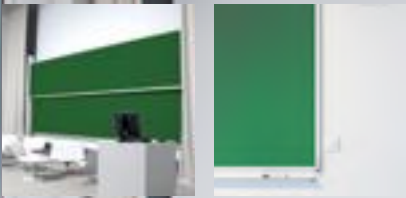

COLOR PIZARRA



/VD /AZ /NG /GR

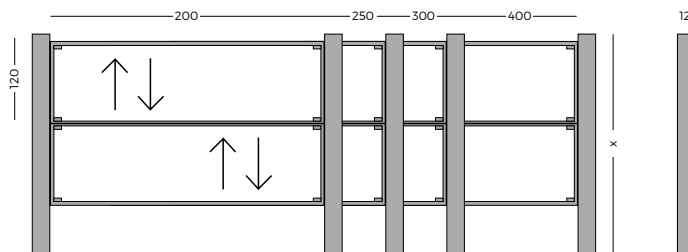

REF	↑	└	┌
730/A2/G1	x	120 x 200	12
730/A2/G2	x	120 x 250	12
730/A2/G3	x	120 x 300	12
730/A2/G4	x	120 x 400	12



PIZARRA GUILLOTINA

ESP Conjunto de 2 pizarras verdes de acero vitrificado sobre una estructura de aluminio anodizado en plata mate montada sobre suelo y pared. Las pizarras son independientes entre sí, guiadas por rodamientos de nylon.

GUILLOTINE CHALK BOARD

ENG 2 enamelled chalkboard mounted upon a supporting structure in silver anodised aluminium on stand or wall fixation. Both writing surfaces slide vertically and are independent of each other. Guidance by nylon castors.

TABLEAU GUILLOTINE

FRA 2 tableaux verts émaillés montés sur une structure en aluminium anodisé couleur argent sur piétement ou fixation murale. Les deux surfaces se déplacent de façon indépendantes et sont guidées par des poulies en nylon.



PS PAINT

PINTURA PIZARRA
PAINT BOARD
TABLEAU PEINTURE



COLOR PINTURA PIZARRA



/NG /AZ /VD /GR /RAL

Más colores bajo pedido.

REF	Color	Ltrs.	M ²
PNT/TZ	4 colores	1	4-5 m ²



PINTURA PIZARRA

ESP Pintura de pared con un acabado de pizarra de tiza que permite escribir y dibujar sobre ella. Una sola capa es suficiente para obtener una superficie lisa. Bote de 1L para cubrir 4-5 m².

PAINT BOARD

ENG Wall paint with a chalkboard finish that allows you to write and draw on it. One layer is sufficient enough to obtain a smooth surface of erasable chalkboard. One 1L can is enough to cover 4-5 m².

PEINTURE TABLEAU

FRA Peinture murale avec finition tableau couleur permettant l'écriture ou le dessin à la craie. Deux couches sont suffisantes pour obtenir une surface lisse et effaçable. Pot d'un litre pour environ 4-5 m².



PS CAPTURE

App by Planning Sisplamo
planningsisplamo.com/pscapture

**7006/1**

*Excl ref. 7012 & 7006

ESP Recambio para borrador de aluminio

Bolsa de 20 uds. de fieltros para borrador.

ENG Aluminium eraser refills

20 felt refills pack for aluminium erasers.

FRA Feutrine remplacement pour effaceur

Jeu de 20 unités de feutrine pour effaceur.

**7006****ESP Borrador de aluminio magnético**

Uso para pizarras. Filtro intercambiable.

ENG Magnetic whiteboard eraser

Use for boards. The filters are replaceable.

FRA Effaceur magnetique

Pour tableaux. Feutrine remplaçable.

**7014****ESP Borrador de plástico**

Uso para pizarras. Filtro intercambiable.

ENG Plastic eraser

Use for boards. The filters are replaceable.

FRA Effaceur en plastique

Pour tableaux. Feutrine remplaçable.

**7014/1****ESP Recambio para borrador de plástico**

2 uds. de fieltros para borrador ref. 7014

ENG Plastic eraser refill

Box of 2 refills for board eraser ref. 7014

FRA Feutrine de remplacement effaceur

Jeu de 2 unités de feutrine pour ref. 7014

**7013/B****ESP Tiza blanca**

Caja de 12 unidades de tizas blancas

ENG White chalk

Pack of 12 white chalk

FRA Craie blanche

Boîte de 12 craies blanches

**BL/ES/0061****ESP Tinta líquida blanca**

Caja de 3 unidades de tinta líquida blanca

ENG White liquid ink

Box 3 units white liquid ink

FRA Encre blanche liquide

Boîte de 3 unités d'encre blanche liquide

**7013/C**

*Excl ref. 7012 & 7006

ESP Tiza de color

Caja de 12 unidades de tizas de colores

ENG Colour chalk

Pack of 12 colour chalk

FRA Craie de couleurs

Boîte de 12 craies de couleurs

**BL/ES/0062****ESP Tinta líquida de colores**

Caja de 5 unidades de tinta líquida de colores

ENG Liquid ink colours

Box of 5 units of liquid ink colours

FRA Encre liquide de couleur

Boîte de 5 unités de couleurs d'encre liquide

**7003 - 7003/30****ESP Cajetín de aluminio**

Cajetín de aluminio de 100 ó 30 cm.

ENG Aluminium tray

100 or 30 cm. long aluminium pen tray

FRA Auget porte marqueurs

Auget en aluminium, porte-marqueurs 100 ou 30 cm.



BL/ES

PIZARRA NEGRA CON MARCO DE MADERA
WOOD FRAME BOARD
TABLEAU CADRE EN BOIS



REF	↑	L	±H
BL/ES/0051	-	40 x 50	2
BL/ES/0052	-	50 x 100	2
BL/ES/0053	-	70 x 120	2
BL/ES/0060	105	60 x 80	66

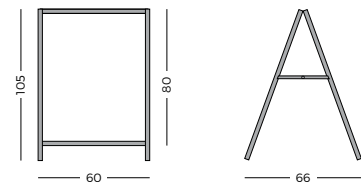
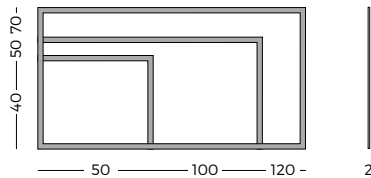

PIZARRA NEGRA

ESP Gama de pizarras negras con marco de madera rústico. Aptas para escritura con tiza tradicional y con rotuladores de tinta líquida. Disponibles en versión mural o caballete doble cara.

BLACK CHALK BOARD

ENG Range of black boards with "antique" wood frame for traditional chalk or liquid ink pens. Wall or double side board.

TABLEAU NOIR

FRA Gamme de tableaux noir avec cadre en bois rustique. Convient pour écriture à la craie traditionnelle et stylos à encre liquide. Disponible en mural ou double face type chevalet.



ESCOLPLAN

PIZARRA MARCO PINO
WOOD FRAME BOARD
TABLEAU AVEC CADRE EN PIN

BASIC

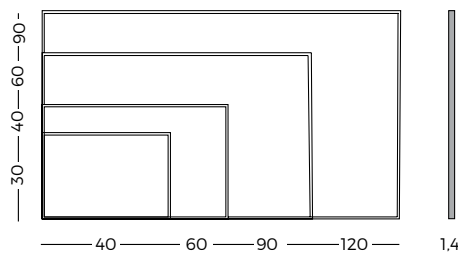

REF	L	H	uts./ box
BL/ES/7371	30 x 40	1,4	40
BL/ES/7372	40 x 60	1,4	20
BL/ES/7373	60 x 90	1,4	10
BL/ES/7374	90 x 120	1,4	6



PIZARRA MARCO PINO

ESP Pizarra verde plastificada y rotulable con tiza, enmarcada con marco pino natural. Disponible en 4 medidas. Incluye herrajes para sujeción.

FLIPCHART WOOD FRAME

ENG Plastic green board for chalks and with pine wood frame available on 4 dimensions. Includes the screws kit.

TABLEAU AVEC CADRE EN PIN

FRA Tableau vert en plastique et encadrée avec cadre en pin naturel pour écriture à la craie. Disponible en 4 dimensions. Comprend le matériel de fixation.

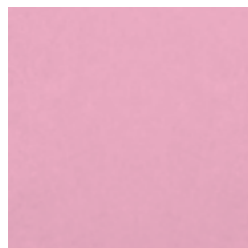

03

INFORMPLAN

TABLEROS DE INFORMACIÓN
BULLETIN BOARDS
TABLEAUX D'INFORMATION



BASIC

TABLERO DE **CORCHO**
CORK BOARD
 TABLEAU **LIÈGE**

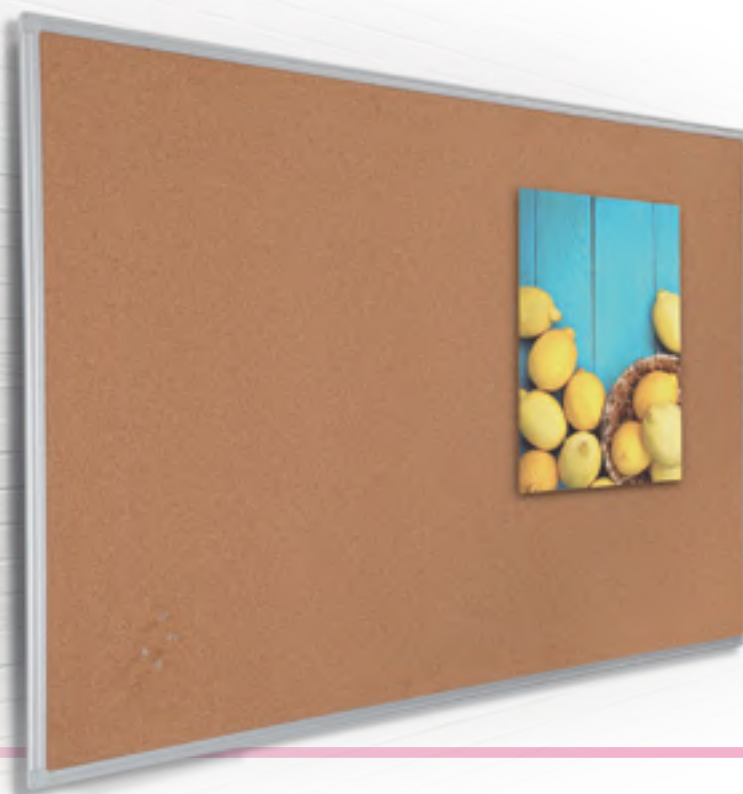

REF	L	H
BL/IN/0101	45 x 60	1
BL/IN/0102	60 x 90	1
BL/IN/0103	90 x 120	1
BL/IN/0114	100 x 150	1
BL/IN/0115	100 x 200	1

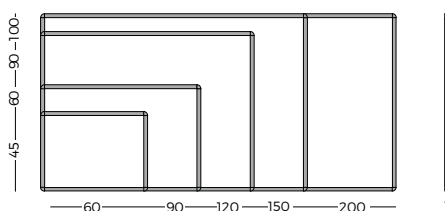

TABLERO DE CORCHO

ESP Tablero de corcho natural de 1 cm. de espesor, con marco de aluminio anodizado en plata mate y cantoneras redondeadas de plástico gris. Disponible en 5 formatos.

CORK BOARD

ENG Natural cork board (1 cm.) with anodized aluminum frame in matt silver with rounded corners made from gray plastic. Available in 5 formats.

TABLEAU LIÈGE

FRA Tableau en liège naturel (1 cm.) avec cadre en aluminium anodisé couleur argent mate et coins arrondis en plastique gris. Disponible en 5 formats.



TABLERO DE **MARCO PINO**
PINE FRAME CORKBOARD
 TABLEAU LIÈGE **CADRE EN PIN**

BASIC

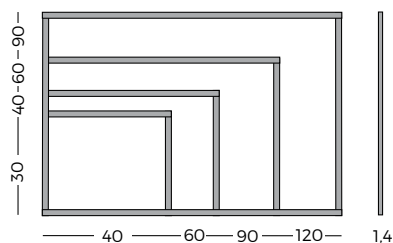

REF	L	- -	unts.
BL/IN/7771	30 x 40	1,4	40
BL/IN/7772	40 x 60	1,4	20
BL/IN/7773	60 x 90	1,4	10
BL/IN/7774	90 x 120	1,4	6



TABLERO DE CORCHO

ESP Tablero de corcho natural con marco de pino barnizado. Disponible en 4 formatos. Incluye pins y herrajes de fijación. Ideal tanto para uso doméstico como para la oficina.

CORK BOARD

ENG Natural cork board with varnished pine wood frame. Available in 4 sizes. Includes fittings. Ideal for home and office use.

TABLEAU LIÈGE

FRA Tableau en liège naturel cadre en pin vernis. Disponible en 4 formats. Comprend matériel de fixation et punaises. Idéal pour la maison et le bureau.



CORK

CORCHOS AUTOADHESIVOS
 AUTOADHESIVE **CORK**
LIÈGE AUTOCOLLANT

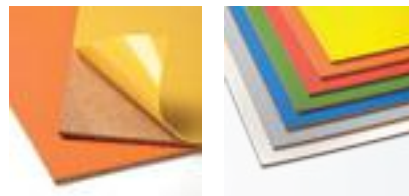

COLOR CORCHO



REF	L	H	uts./ box
BL/IN/0320	40 x 50	0,4	x2 units
BL/IN/0321	40 x 50	0,4	x2 units
BL/IN/0322	40 x 50	0,4	x2 units
BL/IN/0323	40 x 50	0,4	x2 units
BL/IN/0324	40 x 50	0,4	x2 units
BL/IN/0325	40 x 50	0,4	x2 units
BL/IN/0326	40 x 50	0,4	x2 units

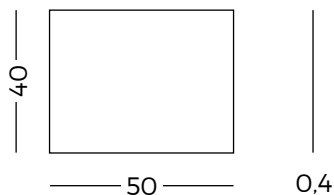

CORCHOS AUTOADHESIVOS

ESP Pack de 2 corchos autoadhesivos de 40 x 50 cm. pintados en colores. Ideal tanto para uso doméstico como para la oficina. Disponible en 7 colores.

FELT BOARD

ENG Set of auto adhesives painted in different colours cork plates 40 x 50 cm. Ideal for home or offices. 7 different colours.

TABLEAU FOND LIÈGE

FRA Pack de plaque de liège autocollants de 40 x 50 cm. peints de couleurs. Idéal pour la maison et le bureau. Disponible en 7 couleurs.



ROLLO DE CORCHO
ROLLER CORK
ROULEAU DE LIÈGE

CORK



COLOR CORCHO



/0320 /0321 /0322 /0323 /0324 /0325 /0326

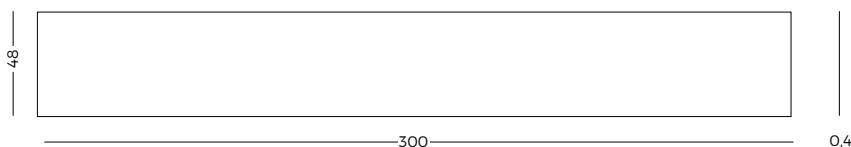

REF	L	H
BL/IN/0420	48 x 300	0,4
BL/IN/0421	48 x 300	0,4
BL/IN/0422	48 x 300	0,4
BL/IN/0423	48 x 300	0,4
BL/IN/0424	48 x 300	0,4
BL/IN/0425	48 x 300	0,4
BL/IN/0426	48 x 300	0,4



ROLLO DE CORCHO ADHESIVO

ESP Rollo de corcho autoadhesivo de 4 mm de grosor de 48 cm x 3 metros pintado de color. Disponible en 7 colores. Ideal tanto para uso doméstico como para la oficina.

ADHESIVE CORK ROLL

ENG Self-adhesive cork roll 4 mm thick 48 cm x 3 meters painted and available in 8 colors. Ideal for both home and office use.

ROULEAU DE LIÈGE DE COLLE

FRA Liège en rouleau de 4 mm d'épaisseur 48 cm x 3 mètres peintes. Disponible en 7 couleurs. Idéal à la fois pour un usage domestique et pour le bureau.



765

TABLERO DE **CORCHO**
CORK BOARD
 TABLEAU **FOND LIÈGE**



REF	L	H	RAIL
765/10	40 x 60	2.2	-
765/1	60 x 80	2.2	-
765/2	80 x 100	2.2	✓
765/3	100 x 120	2.2	✓
765/4	100 x 150	2.2	✓
765/5	100 x 175	2.2	✓
765/6	100 x 200	2.2	-
765/7	100 x 250	2.2	-

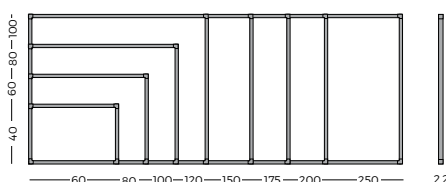

TABLERO DE CORCHO

ESP Tablero de anuncios mural con base de corcho natural, enmarcado con perfil de aluminio anodizado en color plata mate y cantoneras redondeadas de plástico gris. Se pueden fijar sobre su superficie notas, avisos, etc. mediante agujas. Corcho de 5 mm. de grosor.

CORK BOARD

ENG Cork board equipped with silver anodised aluminium frame and grey plastic rounded corners. Ideal for pinning notes, notices, posters etc. Cork thickness: 5 mm.

TABLEAU FOND LIÈGE

FRA Tableau d'affichage en liège avec encadrement en aluminium anodisé couleur argent, coins arrondis en plastique gris. Idéal pour l'affichage de notes, avis, posters, etc... par épingles et punaises. Liège de 5 mm de très bonne qualité.



SOPORTE T

REF	↑	└	⇄
765/2/T	190	100 x 80	53
765/3/T	190	100 x 120	53
765/4/T	190	100 x 150	53
765/6/T	190	100 x 200	53



SOPORTE DELTA

REF	↑	└	⇄
765/2/D	190	100 x 80	53
765/3/D	190	100 x 120	53
765/4/D	190	100 x 150	53
765/6/D	190	100 x 200	53



SOPORTE Y2

REF	↑	└	⇄
765/3 + Y2/120	173	100 x 120	53
765/4 + Y2/150	173	100 x 150	53
765/6 + Y2/200	173	100 x 200	53

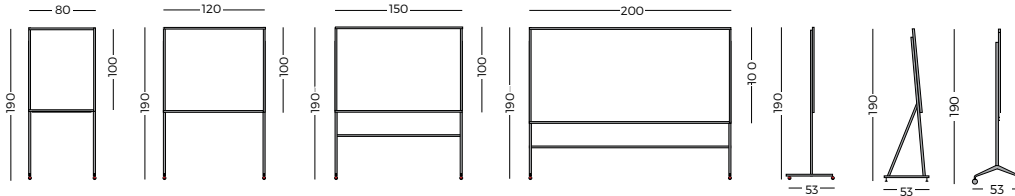

PERSONALIZACIÓN: 765 + ...

REF	└	⇄	pag.
PF/A4/M	30,5 x 22	0,5	144
PF/A5/M	22 x 16	0,5	144



PERSONALIZACIÓN: 765 + ...

REF	└	⇄	pag.
A4/M	24,5 x 22	3,5	142
A5/M	16,5 x 16	3,5	142
A4/3/M	16,5 x 11	3,5	142





760

TABLERO DE **CORCHO TAPIZADO**
FELT BOARD
 TABLEAU **FOND LIÈGE TISSU**

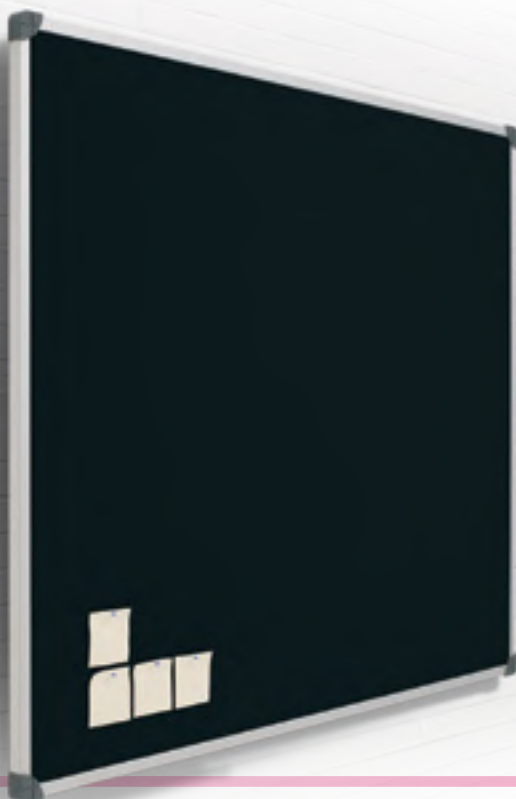
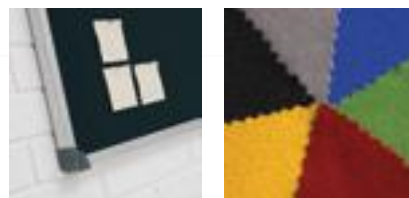

COLOR TAPIZADO

 /NG /BD /AZ /VD /GR /OC

REF	L	H	RAIL
760/10	40 x 60	2.2	-
760/1	60 x 80	2.2	-
760/2	80 x 100	2.2	✓
760/3	100 x 120	2.2	✓
760/4	100 x 150	2.2	✓
760/5	100 x 175	2.2	✓
760/6	100 x 200	2.2	-
760/7	100 x 250	2.2	-

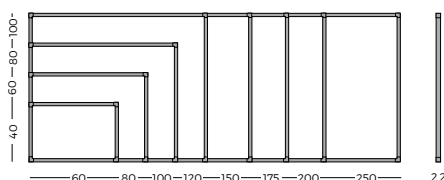

TABLERO DE CORCHO TAPIZADO

ESP Tablero de anuncios mural con base de corcho tapizado, enmarcado con perfil de aluminio anodizado en color plata mate y cantoneras redondeadas de plástico gris. Se pueden fijar sobre su superficie notas, avisos, pósters, etc. mediante agujas o chinchetas. Corcho de 5 mm. de grosor.

FELT BOARD

ENG Felt notice board with cork surface equipped with silver anodised aluminium frame and grey plastic rounded corners. Ideal for pinning notes, notices, posters, etc. Covered with fabric in colours black, bordeaux, blue, green, grey and ochre. Cork thickness: 5 mm.

TABLEAU FOND LIÈGE TISSU

FRA Tableau d'affichage en liège tapissé avec encadrement aluminium anodisé couleur argent et coins arrondis en plastique gris. Idéal pour l'affichage de notes, avis, posters, à l'aide d'épingles et punaises. Liège de 5 mm d'épaisseur de très bonne qualité.



SOPORTE T

REF	↑	└	⇄
760/2/T	190	100 x 80	53
760/3/T	190	100 x 120	53
760/4/T	190	100 x 150	53
760/6/T	190	100 x 200	53



SOPORTE DELTA

REF	↑	└	⇄
760/2/D	190	100 x 80	53
760/3/D	190	100 x 120	53
760/4/D	190	100 x 150	53
760/6/D	190	100 x 200	53



SOPORTE Y2

REF	↑	└	⇄
760/3 + Y2/120	173	100 x 120	53
760/4 + Y2/150	173	100 x 150	53
760/6 + Y2/200	173	100 x 200	53

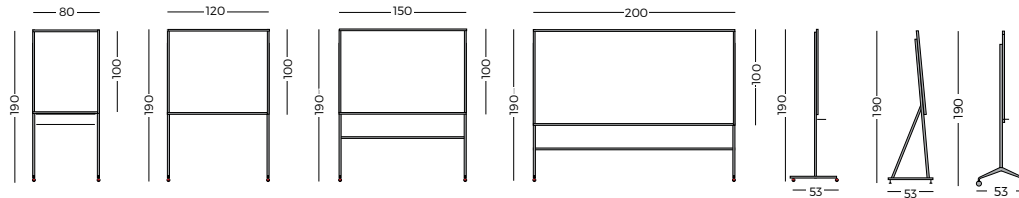

PERSONALIZACIÓN: 760 + ...

REF	└	⇄	pag.
PF/A4/M	30,5 x 22	0,5	144
PF/A5/M	22 x 16	0,5	144



PERSONALIZACIÓN: 760 + ...

REF	└	⇄	pag.
A4/M	24,5 x 22	3,5	142
A5/M	16,5 x 16	3,5	142
A4/3/M	16,5 x 11	3,5	142





ZENIT

TABLERO "ZENIT"
CORK BOARD "ZENIT"
TABLEAU "ZENIT"

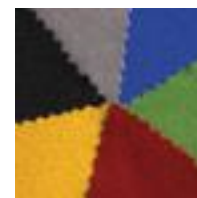

PERFIL LACADO



* /NG /BL /AM /RJ /AZ /VD /NJ

ACABADO / COLOR TAPIZADO



CORK /NG /BD /AZ /VD /GR /OC

REF	L	L ₁	H	RAIL
Z/765/10	40 x 60	53 x 61	2.3	-
Z/765/1	60 x 80	73 x 81	2.3	-
Z/765/2	80 x 100	93 x 101	2.3	✓
Z/765/3	100 x 120	113 x 121	2.3	✓
Z/765/4	100 x 150	113 x 151	2.3	✓
Z/765/5	100 x 175	113 x 176	2.3	✓
Z/765/6	100 x 200	113 x 201	2.3	-
Z/765/7	100 x 250	113 x 251	2.3	-

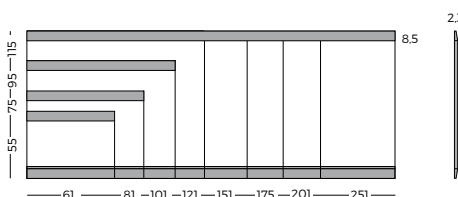

REF	L	L ₁	H	RAIL
Z/760/10	40 x 60	53 x 61	2.3	-
Z/760/1	60 x 80	73 x 81	2.3	-
Z/760/2	80 x 100	93 x 101	2.3	✓
Z/760/3	100 x 120	113 x 121	2.3	✓
Z/760/4	100 x 150	113 x 151	2.3	✓
Z/760/5	100 x 175	113 x 176	2.3	✓
Z/760/6	100 x 200	113 x 201	2.3	-
Z/760/7	100 x 250	113 x 251	2.3	-



TABLERO "ZÉNIT"

ESP Tablero de corcho Zénit enmarcado con perfil de aluminio anodizado en color plata (tapa personalizable). Superficie de corcho natural o tapizada en colores. Se pueden fijar sobre su superficie notas, avisos, pósters, etc, mediante agujas o chinchetas. Corcho de 5 mm. de grosor.

CORK BOARD "ZÉNIT"

ENG Cork or felt notice board, covered with colored fabric, with anodized aluminium frame (customizable). Cork 5 mm, high quality. Ideal for pinning notes, bulletins, posters, etc. Covered with fabric in colours black, bordeaux, blue, green, grey and ochre. Cork thickness: 5 mm.

TABLEAU "ZÉNIT"

FRA Tableau d'affichage avec fond liège ou liège tapissé. Encadrement en aluminium anodisé (personnalisable). Liège de 5 mm, très bonne qualité. Idéal pour l'affichage de notes, avis, posters, à l'aide d'épingles et punaises. Liège de 5 mm de très bonne qualité.



SOPORTE Y2

REF	↑	└	└└	└└└
Z/765/Y2	181	100 x 80	113 x 81	53
Z/765/Y3	181	100 x 120	113 x 121	53
Z/765/Y4	181	100 x 150	113 x 151	53
Z/765/Y6	181	100 x 200	113 x 201	53
Z/760/Y2	181	100 x 80	113 x 81	53
Z/760/Y3	181	100 x 120	113 x 121	53
Z/760/Y4	181	100 x 150	113 x 151	53
Z/760/Y6	181	100 x 200	113 x 201	53

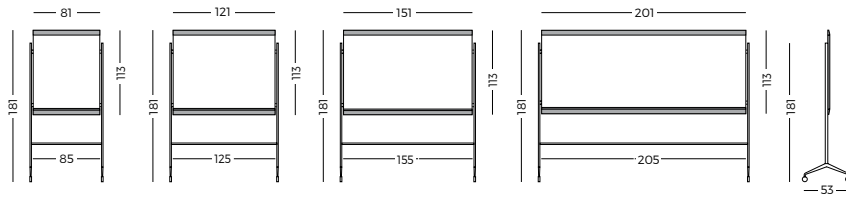

TAPIZADOS

NEGRO - /NG

BURDEOS - /BD

AZUL - /AZ

VERDE - /VD

GRIS - /GR

OCRE - /OC

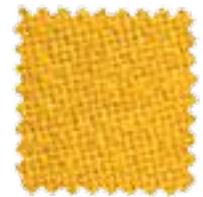
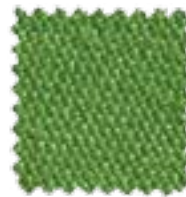

ACCESORIOS

REF: 7051/S

REF: PF/A4/M - PF/A5/M

REF: A4/M - A5/M

REF: A4/M - A5/M

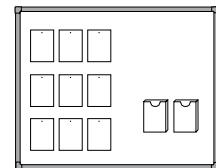

* Ejemplo / Exmpl



PIN PANEL

TABLERO DE ANUNCIOS
INFO BOARD
TABLEAU D'INFORMATION

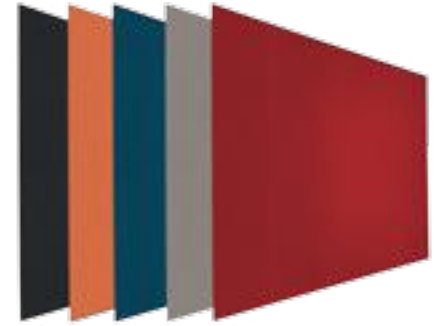
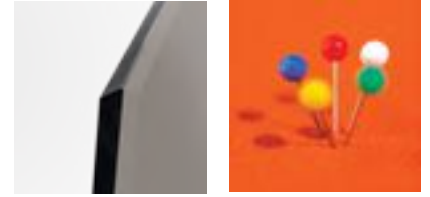

COLOR PIN PANEL



/NG /NJ /AZ /GR /RJ

REF	L	H
7600/1	60 x 90	1,6
7600/2	90 x 120	1,6
7600/3	120 x 180	1,6
7600/4	120 x 200	1,6

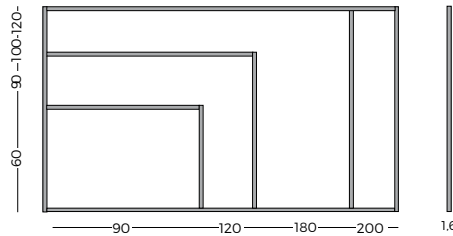

TABLERO DE FORBO

ESP Panel rectangular con el contorno biselado para sujetar notas, avisos, etc. mediante chinchetas. Superficie autoreparable, fabricado con materiales naturales y de elevado componente fonoabsorbente.

FORBO BOARD

ENG Rectangular forbo board panel with bevelled contour for attaching notes, warnings, etc using pins. Autoreparable surface, manufactured with natural materials and high sound-absorbing component.

TABLEAU FORBO

FRA Tableau d'affichage pour accrocher notes, avis etc à l'aide de punaises. Superficie auto-réparable fabriquée avec des matériaux naturelles. Composants phono-absorbents.



COLOR PIN PANEL



/NG /NJ /AZ /GR /RJ

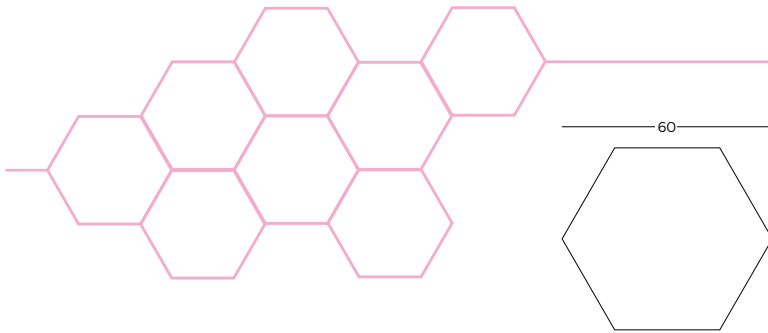

REF	L	H
7606/1	60 x 60	1.6



TABLERO DE FORBO

ESP Panel hexagonal para sujetar notas, avisos, etc. mediante chinchetas. Superficie autoreparable, fabricado con materiales naturales y de elevado componente fonoabsorbente.

FORBO BOARD

ENG Hexagonal forbo board panel with bevelled contour for attaching notes, warnings, etc using pins. Autoreparable surface, manufactured with natural materials and high sound-absorbing component.

TABLEAU FORBO

FRA Tableau hexagonal d'affichage pour accrocher notes, avis etc à l'aide de punaises. Superficie auto-réparable fabriquée avec des matériaux naturelles. Composants phono-absorbents



760/V

**PUERTAS CORREDERAS
SHOWCASE SLIDING DOORS
PORTES COULISSANTES**

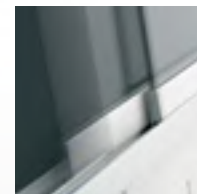
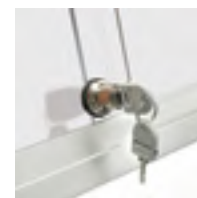

CORK



/NG /BD /AZ /VD /GR /OC



/AV

CORCHO NATURAL

REF	L	□	±
765/V1	60 x 80	2,5	7
765/V2	80 x 100	2,5	7
765/V3	100 x 120	2,5	7
765/V4	100 x 150	2,5	7
765/V5	100 x 175	2,5	7
765/V6	100 x 200	2,5	7



CORCHO TAPIZADO

REF	L	□	±
760/V1	60 x 80	2,5	7
760/V2	80 x 100	2,5	7
760/V3	100 x 120	2,5	7
760/V4	100 x 150	2,5	7
760/V5	100 x 175	2,5	7
760/V6	100 x 200	2,5	7



FONDO AV

REF	L	□	±
720/V1	60 x 80	2,5	7
720/V2	80 x 100	2,5	7
720/V3	100 x 120	2,5	7
720/V4	100 x 150	2,5	7
720/V5	100 x 175	2,5	7
720/V6	100 x 200	2,5	7



VITRINA CON PUERTAS CORREDERAS

ESP Vitrina de anuncios mural con opciones fondo de corcho, corcho tapizado o magnético, marco de aluminio anodizado en color plata mate natural y cantoneras redondeadas de zamak gris, puertas correderas de metacrilato y cerradura con llave.

SHOWCASE WITH SLIDING DOORS

ENG Showcase with cork, felt cork or magnetic surface equipped with silver anodised aluminium frame and grey zamak rounded corners, methacrylate locking sliding doors. Ideal for pinning notes, bulletins, posters, etc.

VITRINE AVEC PORTES COULISSANTES

FRA Vitrine fond en liège, liège tapissé ou magnétique avec encadrement en aluminium anodisé couleur argent, coins arrondis en zamak gris et portes coulissantes en méthacrylate avec serrure. Idéal pour l'affichage de notes, avis, posters, etc., par épingles et punaises.



SOPORTE T

REF	↓	↙	↘	↑
765/V/T2	183	80 x 100	2.5	7
765/V/T3	183	100 x 120	2.5	7
765/V/T4	183	100 x 150	2.5	7
760/V/T2	183	80 x 100	2.5	7
760/V/T3	183	100 x 120	2.5	7
760/V/T4	183	100 x 150	2.5	7



SOPORTE T

REF	↓	↙	↘	↑
720/V/T2	183	80 x 100	2.5	7
720/V/T3	183	100 x 120	2.5	7
720/V/T4	183	100 x 150	2.5	7



KIT LUZ

REF	↓	—
FLU/V1	80	4.2
FLU/V2	100	4.2
FLU/V3	120	4.2
FLU/V4	150	4.2
FLU/V5	175	4.2
FLU/V6	200	4.2

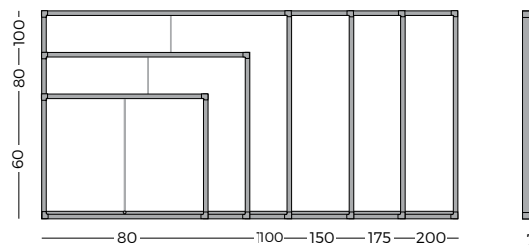
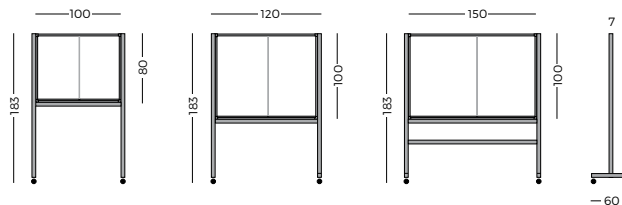

ACCESORIOS

REF: 7051/S



REF: 9002

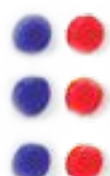

REF: 7005



REF: 7006





ZENIT_v

VITRINA "ZÉNIT" **PUERTA CORREDERA**
 SHOWCASE "ZÉNIT" **SLIDING DOORS**
 VITRINE "ZÉNIT" **PORTES COULISSANTES**



PERFIL LACADO

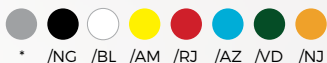

* /NG /BL /AM /RJ /AZ /VD /NJ



CORK



/NG /BD /AZ /VD /GR /OC



/AV

CORCHO NATURAL

REF	L	L ₁	H
Z/765/V1	55 x 75	70 x 80	7
Z/765/V2	75 x 95	90 x 100	7
Z/765/V3	95 x 115	110 x 120	7
Z/765/V4	95 x 145	110 x 150	7
Z/765/V5	95 x 170	110 x 175	7
Z/765/V6	95 x 195	110 x 200	7



CORCHO TAPIZADO

REF	L	L ₁	H
Z/760/V1	55 x 75	70 x 80	7
Z/760/V2	75 x 95	90 x 100	7
Z/760/V3	95 x 115	110 x 120	7
Z/760/V4	95 x 145	110 x 150	7
Z/760/V5	95 x 170	110 x 175	7
Z/760/V6	95 x 195	110 x 200	7



FONDO AV

REF	L	L ₁	H
Z/720/V1	55 x 75	70 x 80	7
Z/720/V2	75 x 95	90 x 100	7
Z/720/V3	95 x 115	110 x 120	7
Z/720/V4	95 x 145	110 x 150	7
Z/720/V5	95 x 170	110 x 175	7
Z/720/V6	95 x 195	110 x 200	7



VITRINA "ZENIT"

ESP Vitrina "Zenit" de anuncios mural con opciones fondo de corcho, corcho tapizado o magnético, marco de aluminio anodizado en color plata mate natural, puertas correderas de metacrilato y cerradura con llave.

SHOWCASE "ZENIT"

ENG Showcase "Zenit" with cork, felt cork or magnetic surface and anodized aluminium frame (customizable). Methacrylate secured sliding doors with key. Ideal for pinning up notes, notices, posters, etc.

VITRINE "ZENIT"

FRA Vitrine "Zenit" fond liège naturel, liège tapissé ou magnétique avec encadrement en aluminium anodisé (personnalisable). Portes coulissantes en méthacrylate avec serrure. Idéal pour l'affichage de notes, avis, posters, etc... par épingles et punaises.



SOPORTE Y2

REF | | L | L₁ | H

Z/765/VY2	181	75 x 95	90 x 100	53
Z/765/VY3	181	95 x 115	110 x 120	53
Z/765/VY4	181	95 x 145	110 x 150	53
Z/765/VY5	181	95 x 170	110 x 175	53
Z/765/VY6	181	95 x 195	110 x 200	53



SOPORTE Y2

REF | | L | L₁ | H

Z/760/VY2	181	75 x 95	90 x 100	53
Z/760/VY3	181	95 x 115	110 x 120	53
Z/760/VY4	181	95 x 145	110 x 150	53
Z/760/VY5	181	95 x 170	110 x 175	53
Z/760/VY6	181	95 x 195	110 x 200	53



SOPORTE Y2

REF | | L | L₁ | H

Z/720/VY2	181	75 x 95	90 x 100	53
Z/720/VY3	181	95 x 115	110 x 120	53
Z/720/VY4	181	95 x 145	110 x 150	53
Z/720/VY5	181	95 x 170	110 x 175	53
Z/720/VY6	181	95 x 195	110 x 200	53

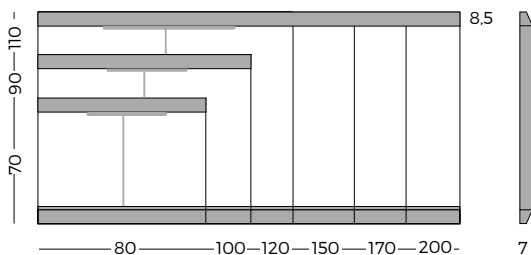
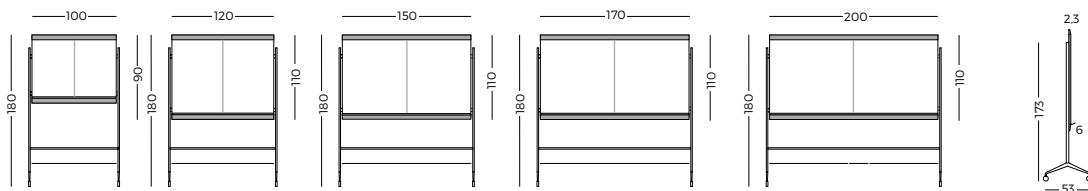

ACCESORIOS

REF: 7051/S



REF: 9002



REF: 7005



KIT LUZ

SIZE



55 x 75	Z/765/NL1	Z/760/NL1	Z/720/NL1
75 x 95	Z/765/NL2	Z/760/NL2	Z/720/NL2
95 x 115	Z/765/NL3	Z/760/NL3	Z/720/NL3
95 x 145	Z/765/NL4	Z/760/NL4	Z/720/NL4
95 x 170	Z/765/NL5	Z/760/NL5	Z/720/NL5
95 x 195	Z/765/NL6	Z/760/NL6	Z/720/NL6





VP

VITRINA CON **PUERTA ABATIBLE**
SHOWCASE WITH **SWING DOOR**
VITRINE **PORTE BATTANTE**



ACABADO



COLOR TAPIZADO



REF	L	h	h ₁
765/VP/1	38 x 50	1,8	3,5
765/VP/2	70 x 50	1,8	3,5
765/VP/3	70 x 75	1,8	3,5

REF	L	h	h ₁	A4
760/VP/1	38 x 50	1,8	3,5	4
760/VP/2	70 x 50	1,8	3,5	6
760/VP/3	70 x 75	1,8	3,5	9

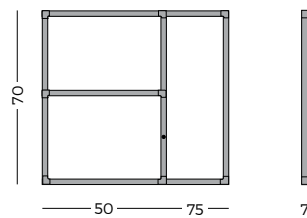

VITRINA CON PUERTA ABATIBLE

ESP Vitrina de anuncios mural con fondo tapizado o corcho natural, marco de aluminio anodizado en color plata mate natural y cantoneras redondeadas de zamak gris, puerta abatible de metacrilato y cerradura con llave. Se pueden fijar: notas, avisos,...

SHOWCASE WITH SWING DOOR

ENG Showcase with cork surface equipped with silver anodised aluminium frame and grey zamak rounded corners and swing doors. Lockable. Ideal for pinning notes, bulletins, posters, etc.

VITRINE À PORTE BATTANTE

FRA Vitrine à porte battante fond liège avec encadrement en aluminium anodisé couleur argent naturel et coins arrondis en zamak gris. Équipée d'une serrure porte en méthacrylate. Idéal pour l'affichage de notes, avis, posters, etc... par épingles et punaises.



VITRINA CON **PUERTA ABATIBLE**
SHOWCASE WITH **SWING DOOR**
VITRINE **PORTE BATTANTE**

BASIC

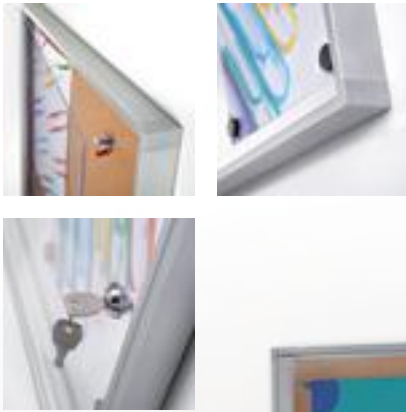

ACABADO



CORK

ACABADO



/BL

REF	L	-H-
BL/IN/0150	68,5 x 51,5	3,5
BL/IN/0151	100,5 x 51,5	3,5
BL/IN/0152	100,5 x 74,5	3,5

REF	L	-H-
BL/IN/0110	68,5 x 51,5	3,5
BL/IN/0111	100,5 x 51,5	3,5
BL/IN/0112	100,5 x 74,5	3,5

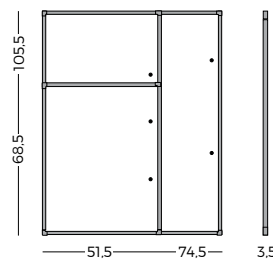

VITRINA BASIC LINE

ESP Vitrina de anuncios de corcho natural o magnética para uso interior. Fabricadas con perfil de aluminio anodizado mate y cantoneras redondeadas grises. Provistas de cerradura con llave. Incluye set de imanes.

SHOWCASE BASIC LINE

ENG Natural cork or magnetic for inside use showcase made with matt anodised aluminium profile and rounded grey plastic corners. Includes a lock with key and a set of magnets.

VITRINE BASIC LINE

FRA Vitrines en liège ou magnétique pour un usage intérieur en profilé d'aluminium anodisé et coins arrondis gris mat. Equipé avec serrure à clé et livrée avec punaises.



767VE

VITRINA **EXTERIOR**
OUTDOOR SHOWCASE
 VITRINE **EXTÉRIEURE**



REF	L	H	A4 ?
767/VE/12	68 x 51	4,5	4
767/VE/13	68 x 72	4,5	6
767/VE/14	98 x 72	4,5	9

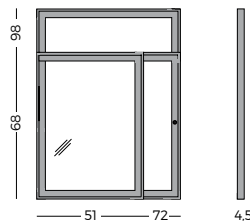

VITRINA DE EXTERIOR

ESP Vitrinas de anuncios murales con marco de aluminio anodizado en color plata mate de puerta abatible de cristal templado y cerradura con llave. Fondo magnético blanco. Estancas a la lluvia por lo que permiten su colocación a la intemperie.

OUTDOOR SHOWCASE

ENG Showcase equipped with silver anodised aluminium frame with or without light. Polycarbonate door with hinges and double safety lock with key. Magnetic whiteboard surface.

VITRINE EXTÉRIEURE

FRA Vitrine d'extérieur avec fond tableau blanc magnétique et encadrement en aluminium anodisé de couleur gris mate. Porte battante en polycarbonate et serrure clé, résistante aux intempéries.



VITRINA EXTERIOR TELESCÓPICA
TELESCOPIC OUTDOOR SHOWCASE
VITRINE EXTÉRIEURE TÉLESCOPIQUE

768VE

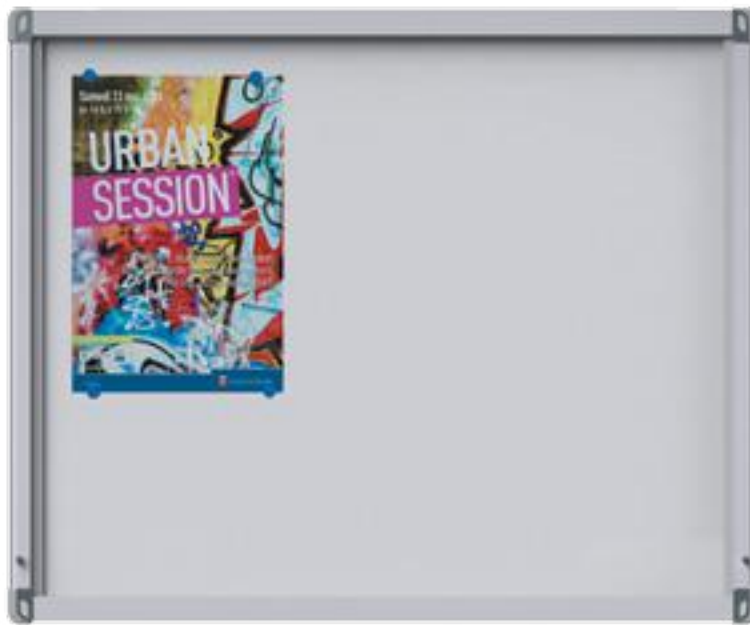

REF	L	H	A4 ?
768/VE/11	99 x 121	5	15
768/VE/12	99 x 163	5	21
768/VE/13	101 x 204	5	27

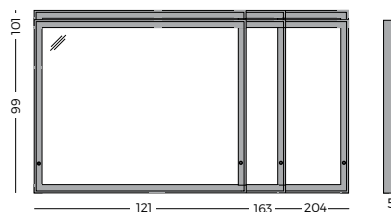

REF	L	H	A4 ?
768/VEP/11	98 x 117	7.5	15
768/VEP/12	98 x 160	7.5	21
768/VEP/13	98 x 202	7.5	27

**VITRINA TELESCÓPICA**

ESP Vitrinas de anuncios murales con marco de aluminio anodizado en color plata mate. Puerta abatible telescópica de cristal templado y doble cerradura con llave. Fondo magnético blanco. Estancias a la lluvia por lo que permiten su colocación a la intemperie.

TELESCOPIC SHOWCASE

ENG Showcase equipped with silver anodised aluminium frame with or without light. Polycarbonate door with hinges and double safety lock with key. Magnetic whiteboard surface. Ideal for exterior.

VITRINE TÉLESCOPIQUE

FRA Vitrine d'extérieur avec fond tableau blanc magnétique et encadrement en aluminium anodisé argent naturel. Portes à l'italienne en polycarbonate avec serrure clé, résistante aux intempéries.



VT

VITRINA **PUERTA TELESCÓPICA**
SHOWCASE **HINGED DOORS**
VITRINE **PORTES TÉLESCOPIQUES**



CORK /NG /BD /AZ /VD /GR /OC



/AV

CORCHO NATURAL / TAPIZADO

REF	L	□	±
765/VT1	60 x 80	1	4,5
765/VT2	80 x 100	1	4,5
765/VT3	100 x 120	1	4,5
760/VT1	60 x 80	1	4,5
760/VT2	80 x 100	1	4,5
760/VT3	100 x 120	1	4,5

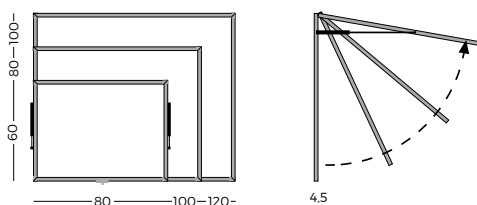

FONDO AV

REF	L	□	±
720/VT1	60 x 80	1	4,5
720/VT2	80 x 100	1	4,5
720/VT3	100 x 120	1	4,5



VITRINA TELESCÓPICA

ESP Vitrina de anuncios mural con fondo de corcho natural, magnético o tapizado, marco de aluminio anodizado en color plata mate natural y puerta abatible de metacrilato mediante telescópico y cerradura con llave. Se pueden fijar sobre su superficie notas, avisos, pósters, etc. El corcho tapizado disponible en seis colores.

TELESCOPIC SHOWCASE

ENG Showcase with natural cork, felt cork or magnetic surface equipped with silver anodised aluminium frame and methacrylat hinged doors and lockable. Ideal for pinning notes, notices, posters, etc. Available in felt cork (6 colours) and mesh (M1).

PORTES TÉLESCOPIQUES

FRA Vitrine à l'italienne fond liège, liège tissu ou magnétique avec encadrement en aluminium anodisé couleur argent naturel. Equipé d'une serrure, porte télescopique en méthacrylate. Idéal pour l'affichage de notes, avis, posters, etc... par épingles et punaises. Tissu disponible en six couleurs.



CORCHO AUTOADHESIVO
AUTOADHESIVE CORK
LIÈGE ADHÉSIF

767

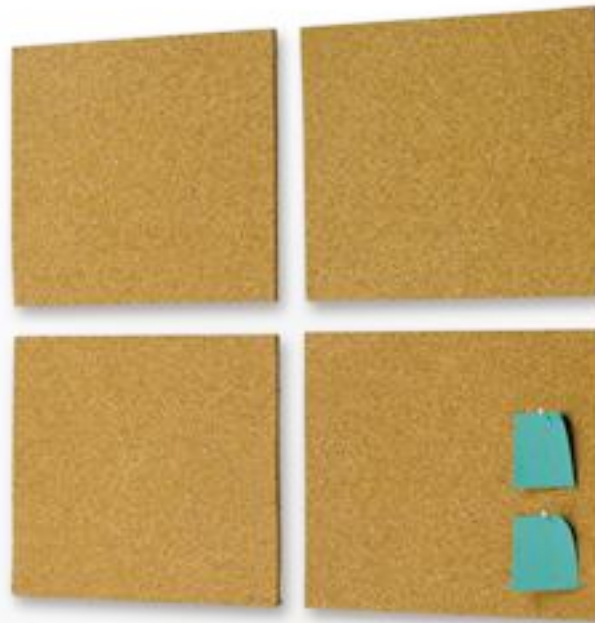

ACABADO



CORK

REF	L	H	uts/box
767	30 x 40	0,5	4 units

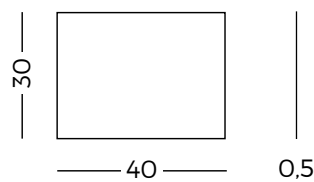

ACCESORIOS

REF: 7051/S



REF: 9002

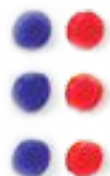

REF: 7005



REF: 7006



VISUALPLAN



PS PAINT

PINTURA MAGNÉTICA
MAGNETIC PAINT
PEINTURE MAGNETIQUE

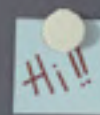

COLOR



/NG

REF	Características	Ltrs.	M ²
PNT/MG	Magnética	1	2 - 2.5 m ²



PINTURA MAGNÉTICA

ESP Pintura de pared magnética con partículas de hierro. Convierte cualquier pared en una superficie magnética. Es posible recubrir con otra pintura para obtener una superficie magnética de color. Bote de 1L, suficiente para cubrir una superficie de 2m² con dos capas.

MAGNETIC PAINT

ESP Magnetic wall paint with iron particles. Turn any wall into a magnetic surface. It is possible to obtain a coloured magnetic surface covering the magnetic paint with a layer or regular paint. 1L is enough to cover a surface of 2m² with two layers.

PEINTURE MAGNETIQUE

ESP Peinture murale magnétique incluant des particules de fer. Converti n'importe quel mur en superficie magnétique. Il est possible de la recouvrir avec une autre peinture afin d'obtenir une superficie magnétique de couleur. Pot d'un litre, suffisant pour couvrir une superficie de 2m² de deux couches.



SUPERFICIE MAGÉTICA

ESP Aplicar dos capas de pintura magnética para obtener una superficie de color negro imantada.

ENG Apply two layers of magnetic paint to obtain a black magnetized surface.

FRA Appliquer deux couches de peinture magnétique pour obtenir une superficie de couleur noire aimantée.



SUPERFICIE MAGNÉTICA DE COLOR

ESP Aplicar otra pintura de color encima de las capas de pintura magnética para obtener una superficie de color imantada.

ENG Apply another color paint on top to obtain a magnetized color surface.

FRA Appliquer une autre couleur par-dessus les deux couches pour obtenir une superficie colorée et aimantée.

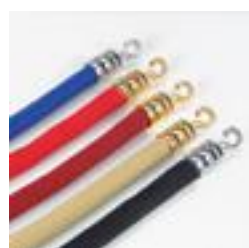

04

EXPOPLAN

SISTEMAS DE EXPOSICIÓN
DISPLAY SYSTEMS
SYSTÈMES D'EXPOSITION



NEXT BASIC

POSTES BASIC DE CORDÓN
 QUEUE ROPE GUIDES
 POTEAUX GUIDES CORDES



POSTE ALUMINIO

REF	↓	↔	∅
805/NG	100	30	5
805/PL	100	30	5
805/DO	100	30	5

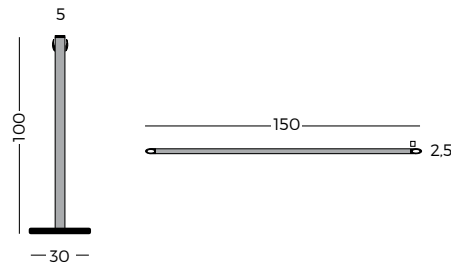

CORDÓN

REF	↓	↔
805/C/NG	2.5	150
805/C/AZ	2.5	150
805/C/RJ	2.5	150
805/C/BD	2.5	150
805/C/CR	2.5	150
806/C/BL	2.5	150
806/C/NG	2.5	150

POSTES "BASIC" DE CORDÓN

ESP Poste separador de aluminio con base metálica negra, resistente y de gran estabilidad, para separaciones de áreas y guiado peatonal. Disponible en 3 colores: negro, plata y oro. Cordón de 1,5 m, disponible en 2 trenzados distintos.

QUEUE GUIDES "BASIC"

ENG Aluminium queue guide with very stable black metallic base for separating different areas and forming organized queues. Available in 3 colours: black, silver and gold. 1.5 meter rope available in different styles (thick or thin braid).

POTEAUX GUIDES "BASIC"

FRA Poteau stable en aluminium, socle métallique noir, très résistant. S'intègrent à tous les espaces d'accueil, délimitation des zones et flux piétonnier. Disponibles en 3 couleurs: noir, argent et or. Cordes de 1,5 m, disponibles en deux types de tresses.



POSTES LUXE DE CORDÓN
QUEUE ROPE GUIDES
 POTEAUX GUIDES **CORDES**

NEXT LUXE



POSTE LATÓN

REF	↑	→	∅
804/CR	95	35	5
804/DO	95	35	5
804/GR	95	35	5
804/PL	95	35	5
804/NG	95	35	5

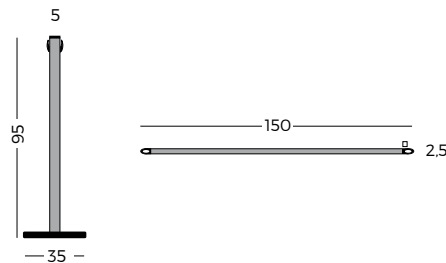

CORDÓN

REF	↑	→
804/C/NG	2.5	150
804/C/AZ	2.5	150
804/C/RJ	2.5	150
804/C/BD	2.5	150
804/C/CR	2.5	150
* 804/CT/BL	2.5	150
* 804/CT/NG	2.5	150

POSTES "LUXE" DE CORDÓN

ESP Poste separador de tubo y base de latón, resistente y de gran estabilidad, para separaciones de áreas y guiado peatonal. Disponible en 5 colores. Cordón de 1,5 m, disponible en 2 trenzados distintos.

QUEUE GUIDES "LUXE"

ENG Queue guide with a very stable brass base for separating different areas and forming organized queues. Available in 5 colours. 1.5 meter rope available in different styles (thick or thin braid).

POTEAUX GUIDES "LUXE"

FRA Poteau avec socle en laiton, très stable et résistant. S'intègre à tous les espaces d'accueil, délimitation des zones et flux des piétons. Disponibles en 5 couleurs. Cordes de 1,5 m, disponibles en deux types de tresses différentes.



NEXT TRAC

POSTE DE CINTA RETRACTIL
RETRACTABLE QUEUE GUIDES
POTEAU GUIDE-FILES À SANGLE RÉTRACTABLE



POSTE

REF	↑	→	∅
808/...	95	35	7
809/...	50	35	7

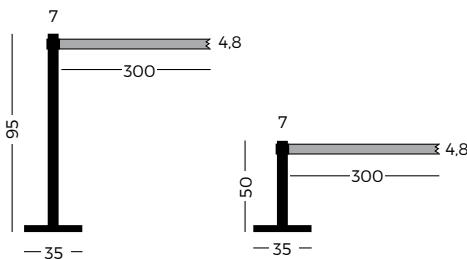

TERMINALES

REF	DESCR.	↑	→	∅
808/F/LC	POSTE FINAL	95	34	7
808/F/M	POSTE FINAL	95	34	7
800/TP	MURAL	7	1	-

POSTES DE CINTA EXTENSIBLE RETRÁCTIL

ESP Poste separador metálico de 95 y 50 cm de alto, para separaciones de áreas y guiado peatonal. Disponibles en varios colores tanto de poste como de cinta, disponible en 3 m. de largo. El cabezal del poste incorpora 3 vías de enganche.

RETRACTABLE QUEUE GUIDES

ENG 50 or 95 cm height barrier-post for areas delimitation and users guidance. Posts and tapes available in different colors. 3 m. tapes. 1 tape starting slot and 3 ending slots for multiple layouts.

POTEAU GUIDE-FILES À SANGLE RÉTRACTABLE

FRA Poteau guide-file de 50 ou 95 cm. de haut pour délimitation d'espaces et guidage des usagers. Poteaux et sangles disponibles dans différentes couleurs. Sangles de 3 m. Un départ de sangle et 3 arrivées permettant de nombreuses configurations.



TERMINAL

REF: L [?]

800/PP 30 x 21 A4



PRINT

DESCR.

ESP Consigue una cinta retráctil personalizada con el logotipo de tu empresa o marca. Contáctate con nuestra Oficina Técnica para más detalles.

ENG Customize your queue guides with a company or brand logo. For more information, contact our Technical Departments.

FRA Obtenir votre sangle retractable personnalisée avec le logo ou la marque de votre entreprise. Contactez nous pour plus de détail.

GAMA DE COLORES

REF: /NG /GR /AZ /RJ /AM /VD /BL /PER



REF:	/BL	/NG	/GR	/AZO	/AZ	/BD	/RJ	/NJ	/AM	/FL	/VD
ESP	Blanco	Negro	Gris	Azul oscuro	Azul	Burdeos	Rojo	Naranja	Amarillo	Fluorescente	Verde
ENG	White	Black	Grey	Dark Blue	Blue	Cardinal	Red	Orange	Yellow	Fluorescent	Green
FRA	Blanche	Noir	Gris	Bleu foncé	Bleu	Bordeaux	Rouge	Orange	Jaune	Fluorescent	Vert



NEXT LUXE

POSTES "LUXE" DE CINTA RETRÁCTIL
RETRACTABLE QUEUE GUIDES "LUXE"
CORD POTEaux GUIDES



ACABADO POSTE

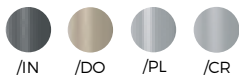

REF ↓ ↑ ∅

808/...	95	35	7
809/...	35	35	7



COLOR CINTA

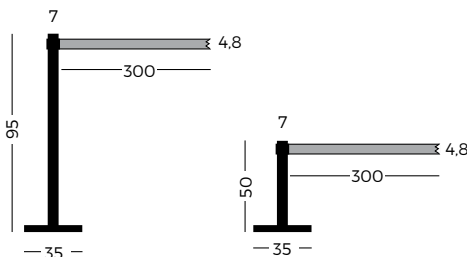

POSTES "LUXE" DE CINTA RETRACTIL

ESP Poste separador metálico de 95 y 50 cm de alto, para separaciones de áreas y guiado peatonal. Disponibles en varios colores tanto de poste como de cinta, disponible en 3 m. de largo. El cabezal del poste incorpora 3 vías de enganche.

RETRACTABLE QUEUE GUIDES "LUXE"

ENG 50 or 95 cm height barrier-post for areas delimitation and users guidance. Posts and tapes available in different colors. 3 m. tapes. 1 tape starting slot and 3 ending slots for multiple layouts.

POTEAU GUIDE-FILES À SANGLE RÉTRACTABLE

FRA Poteau guide-file de 50 ou 95 cm. de haut pour délimitation d'espaces et guidage des usagers. Poteaux et sangles disponibles dans différentes couleurs. Sangles de 3 m. Un départ de sangle et 3 arrivées permettant de nombreuses configurations.



EXPOPLAN

POSTES "ECO" DE CINTA RETRÁCTIL
BARRIER-POST "ECO" RETRACTABLE
POTEAUX GUIDE-FILE "ECO" À SANGLE RÉTRACTABLE

NEXT ECO



COLOR CINTA



/NG /RJ

ACABADO POSTE



/NG

REF	↑	→	∅
803/E2/NG	95	35	7
803/E2/RJ	95	35	7

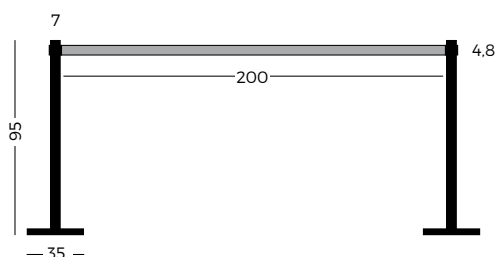

2 POSTES METÁLICOS "ECO" CINTA EXTENSIBLE

ESP Caja de 2 postes separadores metálicos de 95 cm de alto, para separaciones de áreas y guiado peatonal. Poste de color negro y cinta retráctil de 2 m. disponible en rojo y negro.

SET OF 2 BARRIER-POSTS "ECO"

ENG Barrier-post eco 95 cm for areas delimitation and users guidance. Black posts, tape available in red or black. One starting slot and 3 ending slots for multiple layouts.

LOT DE 2 POTEAUX GUIDE-FILE "ÉCO"

FRA Poteau guide-file éco 95 cm. de haut pour délimitation d'espaces et guidage des usagers. Poteaux noirs, sangle rouge ou noire. Un départ de sangle et 3 arrivées permettant différentes configurations.



NEXT AXIAL

POSTES "AXIAL" CINTA RETRÁCTIL
RETRACTABLE BARRIER-POST "AXIAL"
POTEAU GUIDE-FILE "AXIAL" À SANGLE RÉTRACTABLE



ACABADO POSTE



/NG /PL /RJ

COLOR CINTA



/BL /NG /CR /AZO /AZ /BD /RJ /NJ /AM /FL /VD

REF	↑	→	∅
808/X/PL	95	34	7
808/X/NG	95	34	7
808/X/RJ	95	34	7

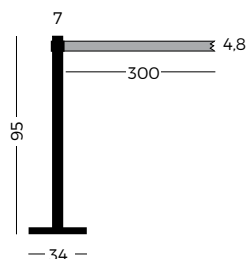

POSTES "AXIAL" CINTA RETRÁCTIL

ESP Poste separador metálico Axial de 95 cm de alto, para separaciones de áreas y guiado peatonal. Disponibles en negro, rojo y plata y 11 colores de cinta retráctil 3 m. Su base en aspa, permite ser apilados para su almacenaje.

BARRIER-POST "AXIAL"

ENG Metallic barrier-post 95 cm. Post and tapes 3m. Different colors available. One starting slot and 3 ending slots for multiple layouts. Cross shaped base for an easier moving and stocking.

POTEAU GUIDE-FILE "AXIAL"

FRA Poteau guide-file en métal de 95 cm. Poteaux et sangles 3 m. Un départ et 3 arrivées permettant différentes configurations. Base en forme de croix qui permet de les empiler pour un rangement et un déplacement plus facile.



EXPOPLAN

CINTA EXTENSIBLE RETRÁCTIL MURAL
WEBBING FELT (FOR WALL)
SANGLE RETRACTABLE MURALE

NEXT WALL



POSTE MURAL

REF	↑	→
800/23	4,8	250
800/37	4,8	370
800/52	4,8	500
800/77	4,8	700

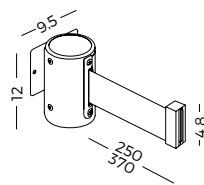

TERMINAL MURAL

REF	↙
800/TP	7 x 1

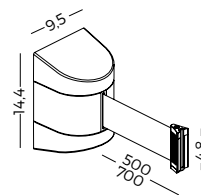

CINTA EXTENSIBLE RETRÁCTIL MURAL

ESP Elemento mural de cinta extensible retráctil, permite de manera rápida y segura aislar provisionalmente áreas o zonas de paso, y cerrar puertas o zonas determinadas. Disponible en 4 longitudes; 2,5 m., 3,7 m., 5,2 m. y 7,7 m.

WEBBING FELT (FOR WALL)

ENG Wall adjustable barrier belt for quick and easy use to close off areas temporarily. Available in 4 lengths; 2,5 m., 3,7 m., 5,2 m. y 7,7 metres.

SANGLE RETRACTABLE MURALE

FRA Sangle murale rétractable avec système d'autofreinage afin qu'elle ne se rétracte pas brusquement en cas de décrochage. Délimitation efficace et rapide de tout type de surfaces. Disponible en quatre longueurs: 2,5 m., 3,7 m., 5,2 m. et 7,7 mètres.



NEXT_{IND}

POSTES METÁLICO **INDUSTRIAL**
 BARRIER POST FOR **INDUSTRIAL**
 POTEAUX INDUSTRIELS POUR **INDUSTRIEL**

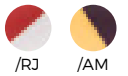

POSTE ALUMINIO

REF	↓	→	∅
802/IN/RJ	95	34	7
802/IN/AM	95	34	7

CINTA

REF	↓	→
800/IN/RJ	4,8	300
800/IN/AM	4,8	300

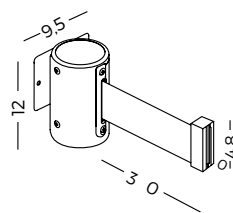
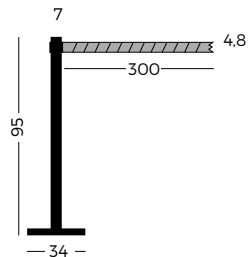

POSTES METÁLICO INDUSTRIAL

ESP Poste separador metálico de 95 cm de alto, para separaciones de áreas y guiado peatonal. Disponibles en varios colores tanto de poste como de cinta, disponible en 3 m. de largo. El cabezal del poste incorpora 3 vías de enganche.

BARRIER POST INDUSTRIAL

ENG Metallic queue guides for area delimitation and user guidance. Post and tapes available in different colors. 3 m. Wall start available.

POTEAUX INDUSTRIELS

FRA Guide file en métallique de 95 cm. de haut pour délimitation d'espaces et guidage des usagers. Poteaux et sangles disponibles en plusieurs couleurs et en départ mural Sangles de 3 m.



EXPOPLAN

807

POSTES METÁLICOS PARA EXTERIOR OUTDOOR METALLIC QUEUE GUIDES POTEAUX D'EXTERIEUR

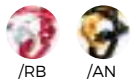

POSTE ALUMINIO

REF	↓	→	∅
807/RJ	100	30	2.5
807/AM	100	30	2.5



CADENAS

REF	↓	→
807/RB/5	3	500
807/RB/25	3	2500
807/AN/5	3	500
807/AN/25	3	2500

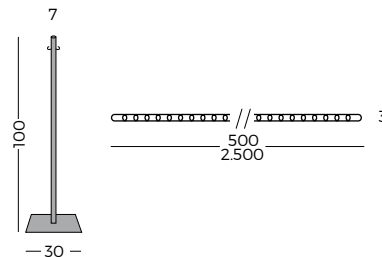

POSTES METÁLICOS PARA EXTERIOR

ESP Poste separador de hierro lacado, resistente y de gran estabilidad, ideal para separaciones de áreas públicas y privadas en el exterior. Disponible en 2 colores: Rojo y amarillo. Cadena de plástico de doble color (rojo/blanco y amarillo/negro).

OUTDOOR METALLIC QUEUE GUIDES

ENG Iron metallic queue guides with a very stable base for separating different areas. Available in 2 colours: Red and yellow. The plastic chain comes in colour combinations red/white or yellow/black.

POTEAUX D' EXTÉRIEURE

FRA Poteau en fer, résistant et très stable pour délimiter des espaces et orienter. Coloris: Rouge et jaune. Chaîne à maillons combinés: rouge/blanc ou jaune/noir. Longueur 5 m ou 25 m.



821-823

ATRIL DE MARCO ABATIBLE
SNAPFRAME LECTERN
 PUPITRE À CADRE CLIPPANT



821

REF	↑	→	☐
821/A3	110	30 x 40	33 x 45
821/A4	110	30 x 40	33 x 24

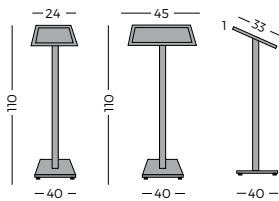

ATRIL DE MARCO ABATIBLE

ESP Atril expositor de aluminio de marco abatible para exponer toda clase de información, catálogos, menús,... El portapóster superior A4 y A3 permite adaptarse al soporte en posición vertical u horizontal.

823

REF	↑	→	☐	CA
823/PF	116,3	25 x 33	A4	No

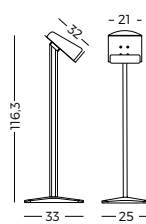

SNAPFRAME LECTERN

ENG Snapframe aluminium display, ideal to show all sorts of information, catalogues, menus, etc... The upper snapframe A4 and A3 allows to place it vertical or horizontal.

823/CA

REF	↑	→	☐	CA
823/PF/CA	127,6	25 x 33	A4	Si

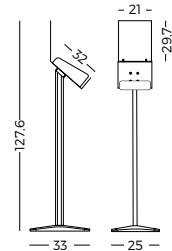

PUPITRE À CADRE CLIPPANT

FRA Pupitre en aluminium à cadre clippant pour exposer tout type d'informations, catalogues, menus, etc... Le porte affiche A4 ou A3 peut se positionner horizontalement ou verticalement.



ATRIL MARCO **ABATIBLE Y REGULABLE**
ADJUSTABLE LECTERN WITH SNAP FRAME
MENUBOARD FLEXIBLE



REF	L	L	?
822/A3	42 x 30	0 - 90°	A3
822/A4	33 x 24	0 - 90°	A4

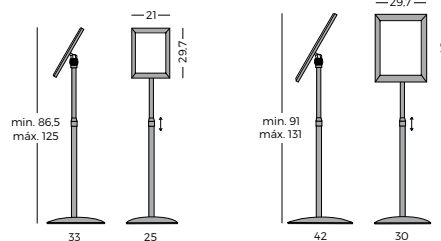
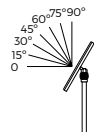

ATRIL MARCO ABATIBLE Y REGULABLE

ESP Atril expositor graduable en altura de aluminio de marco abatible para exponer toda clase de información, catálogos, menús. El portapóster superior Din A4 y Din A3 permite adaptarse al soporte en posición vertical y horizontal y es graduable en inclinación de 0° a 90°. (Disponible con caja de luz LED)

ADJUSTABLE LECTERN WITH SNAP FRAME

ENG Height adjustable lectern made of aluminium and with snap frame to hold menus, catalogues, general information...The snap frame is available in A4 and A3 format and can be positioned horizontal or vertically and with a inclination from 0° to 90°. (Led showcase light available)

REF	L	L	?	Light
822/A3/L	42 x 30	0 - 90°	A3	2000-2200 W
822/A4/L	33 x 24	0 - 90°	A4	2000-2200W



MENUBOARD FLEXIBLE

FRA Pupitre exposant réglable en hauteur et en aluminium avec cadre auto clippant pour exposer toutes sortes d'informations, catalogues, menus. La partie supérieure pour documents format A4 et A3 et avec l'inclinaison verticale et horizontale réglable de 0° à 90°. (Disponible Pupitre exposant avec LED)



832-2400

EXPOSITORES DE INFORMACIÓN
INFO DISPLAYS
PORTE-AFFICHES
REF

832/4 184 72 x 40 4

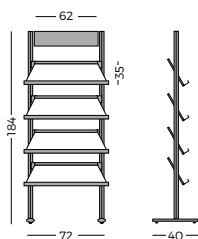
REF

2400/1B 184 72 x 40 1

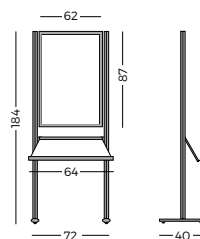
**EXPOSITORES DE INFORMACIÓN**

ESP Expositores compuestos por 2 perfiles elípticos verticales de aluminio en plata mate, con estantes metálicos pintados en color gris. Ideal para catálogos y revistas en formato DIN A4. Los estantes pueden situarse en un lado.

INFO DISPLAYS

ENG Displays made of 2 vertical elliptical aluminum supports in matt silver. Metallic shelves painted in grey. Ideal for catalogues and magazines in A4 format. The shelves can be placed on one side. At the top there is a grey panel, which can be personalized.

PORTE-AFFICHES

FRA Présentoirs composés de 2 supports elliptiques verticaux en aluminium couleur argent mat avec des étagères métalliques grises. Idéal pour catalogues et revues format A4. Les étagères sont disponible en simple face ou double.



EXPOPLAN

EXPOSITORES DE INFORMACIÓN
MAGAZINES DISPLAYS
PRÉSENTOIRS

QUADRA



REF | → ?

Q/400/PE 195 100 x 40 1
Q/400/PE/D 195 100 x 40 2

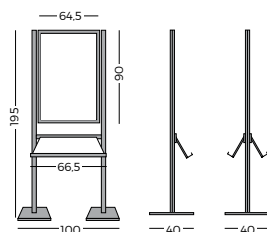

REF | → ?

Q/400/3 195 100 x 40 3
Q/400/3/D 195 100 x 40 6

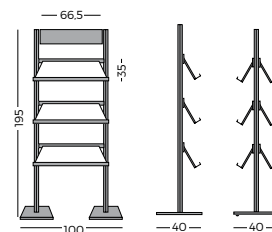

EXPOSITORES DE INFORMACIÓN "QUADRA"

ESP Conjunto formado por un portapósters de formato DIN A1, a una o dos caras y portaestantes metálico gris sobre estructura doble de aluminio anodizado en plata mate, serie Quadra.

MAGAZINES DISPLAYS "QUADRA"

ENG Displays made of 2 vertical elliptical aluminum supports in matt silver. Metallic shelves painted in grey. Ideal for catalogues and magazines in A4 format. The shelves can be placed on one or both sides.

PRÉSENTOIRS "QUADRA"

FRA Présentoirs composés de 2 supports "Quadra" verticaux en aluminium couleur argent mat avec des étagères métalliques grises. Idéal pour catalogues et revues format A4. Les étagères peuvent se situer sur un ou deux côtés.



850

PORTAPÓSTERS MARCO ABATIBLE
WALL SNAPFRAME
CADRE MURAL "CLIPPANT"



REF

850/I/M0	87 x 122	82 x 117	1,2	A0
850/I/M1	63 x 87	57 x 82	1,2	A1
850/I/M2	45 x 63	40 x 58	1,2	A2
850/I/M3	73 x 103	68 x 98	1,2	70 x 100
850/I/M4	53 x 73	48 x 68	1,2	50 x 70
850/I/M5	32 x 44	42 x 29,7	1,2	A3
850/I/M6	23 x 32	21 x 29,7	1,2	A4

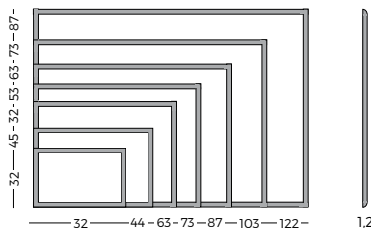

PORTAPÓSTERS MARCO ABATIBLE

ESP Sistema de presentación de pósters, con marco abatible de aluminio anodizado en plata mate a inglete, que permite la sustitución del impreso de una manera rápida y cómoda.

WALL SNAPFRAME

ENG Modern and practical snapframe with durable aluminium clip frames and mitred corners. Folding for posters presentation. Poster or sheets are protected by a thin laminated plastic AV proof non reflects.

CADRE MURAL "CLIPPANT"

FRA Porte-affiche en aluminium anodisé couleur argent angles droits. Ces cadres garantissent une excellente tenue des documents. L'affiche des documents sont protégées par une feuille en plastique transparente anti reflets - anti UV.



DELTA (DOUBLE FACE)

REF | L | W | H | A

850/I/D4	93	73 x 53	68 x 48	A1
850/I/D1	107	87 x 63	82 x 57	50 x 70
850/I/D3	123	103 x 73	98 x 68	70 x 100

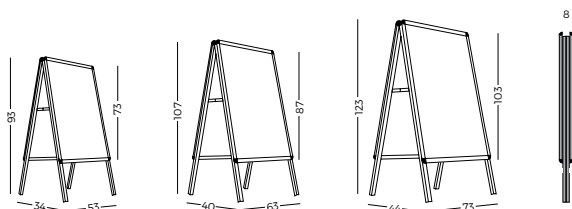

SUSPENDIDO (DOUBLE FACE)

REF | L | W | TH | A

850/I/S/2	45 x 63	40 x 58	2.4	A2
850/I/S/1	63 x 87	57 x 82	2.4	A1
850/I/S/0	87 x 122	82 x 117	2.4	A0
850/I/S/3	73 x 103	68 x 98	2.4	50 x 70
850/I/S/4	53 x 73	48 x 68	2.4	70 x 100

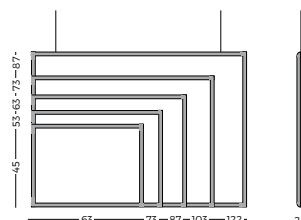

PERFIL LACADO



* /NG /BL /AM /RJ /AZ /VD /NJ

PERSONALLIZACIÓN

CUSTOMIZATION / PERSONNALISATION

Bajo pedido / Under order / Sous commande

Opcional / Optional / Optionelle

Preguntar cantidad / Ask quantit / Démander quantité





852

BANNER PORTAPÓSTERS
WALL SUSPENDED POSTERSNAPPER
BANNER PORTE-AFFICHES



REF	Póster	External	?
852/A4	21	21,6	A4
852/A3	30	30,6	A3
852/A2	42	42,6	A2
852/A1	60	60,6	A1
852/A0	85	85,6	A0
852/P5	50	50,6	50 x 70
852/P7	70	70,6	70 x 100

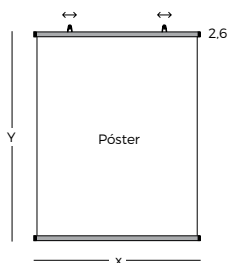

BANNER PORTAPÓSTERS

ESP Suspendido doble cara de marco abatible de aluminio anodizado en plata mate, que permite la sustitución del impreso de una manera rápida y cómoda mediante el perfil en forma de pinza que sujeta el póster mediante sistema de clip.

WALL SUSPENDED POSTERSNAPPER

ENG Double sided banner display made of silver anodised aluminium. Ideal for fixing posters or light paper banners. The clamp profiles guarantee quick and easy exchange of the banner. Easily erected and dismantled. Available in A size and póster formats.

BANNER PORTE-AFFICHES

FRA Profil clippant en aluminium anodisé couleur argent pour poster par suspension. Facile a accrocher ainsi que pour changer l'information. Simple ou double face.



EXPOPLAN

PERFIL PORTANOTAS
NOTES HOLDER PROFILE
 PROFIL DE SUPPORT DE NOTES

NOTE

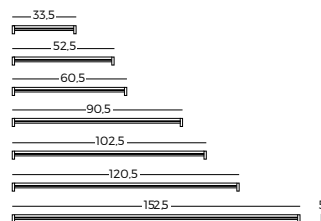
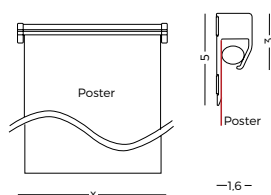

REF	Póster	(x)	- -
BL/EX/0040	31	33,5	5
BL/EX/0041	50	52,5	5
BL/EX/0042	58	60,5	5
BL/EX/0043	88	90,5	5
BL/EX/0044	100	102,5	5
BL/EX/0045	118	120,5	5
BL/EX/0046	150	152,5	5



PERFIL PORTANOTAS

ESP Perfil de aluminio anodizado en color plata mate que se fija a la pared mediante tornillos ocultos en la tapa lateral, para fijar notas, pósters, dibujos, planos, etc.

NOTES HOLDER PROFILE

ENG Silver anodised aluminium profile fixed to the wall through hidden screws on the lateral cover. Ideal for hanging up notes, posters, drawings, plans, etc...

PROFIL DE SUPPORT DE NOTES

FRA Profil en aluminium anodisé mat, fixé au mur par des vis ou par une bande magnétique (au choix). Idéal pour fixer des notes, posters, dessins, plans, etc...



ZIG-ZAG

PORTACATÁLOGOS **ZIG-ZAG**
ZIG-ZAG DISPLAY FOR CATALOGUES
DISPLAY ZIG-ZAG PORTABLE



REF



833/ZZP 34 x 134,5 5 x A4

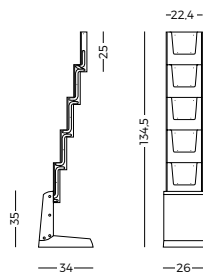

PORTACATÁLOGOS ZIG-ZAG

ESP Gama de expositores Zig-Zag de pie para revistas y catálogos contruidos en aluminio y/o metacrilato y de formato A4. Estructuras desmontables o plegables. Ideal para ferias, congresos, exposiciones, etc.

ZIG-ZAG DISPLAY FOR CATALOGUES

ENG Range of Zig-Zag display for catalogues and magazines made of aluminium and/or methacrylates with pocket size for A4. Dismountable structure and foldable. Ideal for exhibition, fairs, hotels.

REF



BL/EX/0210 42 x 167 6 x A4

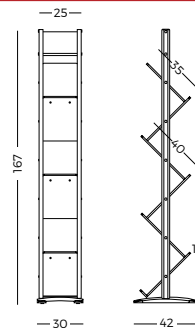

DISPLAY ZIG-ZAG PORTABLE

FRA Gamme de display exposants sur pied Zig-Zag pour magazines et catalogues fabriqué en aluminium et/ou en méthacrylate format A4. Structures amovibles ou pliables. Idéal pour des salons professionnels, conférences, expositions.



EXPOPLAN

EXPOSITORES PARA CATÁLOGOS
INFORMATION RACKS
PRÉSENTOIRS

835



REF



835/C/10

143

27 x 35 10 x A4

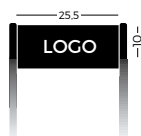
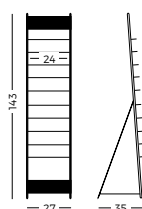

*Logo opcional / Logo optional

EXPOSITORES PARA CATÁLOGOS

ESP Expositores para catálogos y/o revistas verticales construidos con varilla negra y cromada. Su estructura es desmontable y plegable y está disponible para catálogos formato A4 (Disponible en 10 casillas).

INFORMATION RACKS

ENG Information racks for catalogues and/or magazines manufactured with black chrome stems. Dismantle the structure easily for temporary use. Available for catalogues in A4 format (10 trays).

PRÉSENTOIRS

FRA Présentoir à catalogues et/ou revues verticales fabriqués en métal noir et chromée. Structure démontable et pliable pour formats A4 (10 encoches).



837

EXPOSITOR INCLINADO
INCLINED DISPLAY
PRÉSENTOIR INCLINÉ



*Casilleros no incluidos

REF	↑	→	?
837/24	150	24	4 x A4
837/45	150	45	8 x A4

REF	L	→	?
837/S	35 x 24	11.5	A4

REF	L	→	?
V/A4	30 x 21	3	A4
V/A5	21 x 15	3	A5
V/A4/3	15 x 10	3	1/3 A4

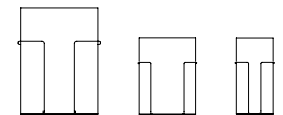
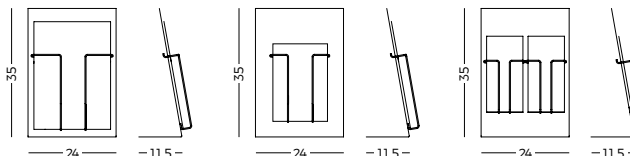
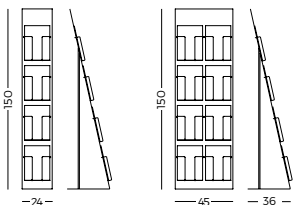

EXPOSITOR DE CHAPA "ALIANS"

ESP Expositor de chapa con cajetines de varilla metálica formando la composición deseada en cada momento. Las cajetines están disponibles en Din A4, A5 y formato tríptico. La parte superior puede ser rotulada o vinilada bajo pedido.

INCLINED DISPLAY "ALIANS" IN METAL

ENG Inclined display "Alians" made of perforated metallic structure and surface with metallic wire trays. Trays sizes can be A4, A5 or 1/3 of A4. Upper side can be personalized (logo or text).

PRÉSENTOIR INCLINÉ "ALIANS" EN MÉTAL

FRA Présentoir incliné "Alians" en métal Présentoir incliné en métal perforé avec porte-brochures en tiges métalliques. Composition modulable sur formats A4 et A5 et tryptique. La partie supérieure peut être personnalisée (logo ou texte).



EXPOPLAN

PANEL MURAL
WALL DISPLAY
PRÉSENTOIR MURAL

845



*Casilleros no incluidos

REF L H W D

845/TEN/120 190 127 x 80 9 x A4
845/TEN/80 190 92 x 80 6 x A4

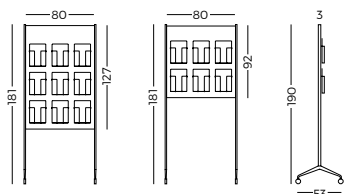

PANEL "EXPO-WALL" MURAL

ESP Conjunto portafolletos mural de chapa perforada para cajetines de varilla metálica disponibles en Din A4, A5 y 1/3 de A4 y formato tríptico. La parte superior puede ser rotulada o vinilada (no incluye rótulo).

REF L H W D

845/M/120 127 80 9 x A4
845/M/80 92 80 6 x A4
845/M/60 67 80 3 x A4

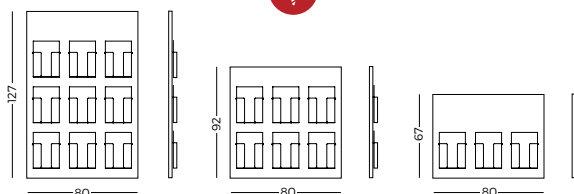

WALL DISPLAY "EXPO-WALL"

ENG Range of wall displays made of perforated metallic surface and with A4 and A5 or 1/3 of A4 wire trays. The upper board can be personalized or signed with vinyl or with curved or flat profile.

REF L H W D

V/A4 30 x 21 3 A4
V/A5 21 x 15 3 A5
V/A4/3 15 x 10 3 1/3 A4

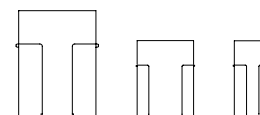

PRÉSENTOIR "EXPO-WALL" MURAL

FRA Présentoir mural en métal perforé. Porte-brochures en tige métal aux formats A4, A5 et 1/3 de A4. La partie supérieure peut être personnalisée sur un ruban de signalétique (profil de signalétique non inclus).



840

PORTAFOLLETOS MURALES Y CON PIÉ
WALL AND FLOOR ANNOUNCEMENT BOARDS
PORTE BROCHURES



COLOR TAPIZADO



REF	L	W	?	REF	H	L	W	?	REF	H	L	W	?	REF	H	L	W	?
			A4					A4					A4					A4
840/G	115 x 80	3	9 x A4	840/TG	190	115 x 80	3	9 x A4	840/DG	190	115 x 80	3	9 x A4	840/QG	195	115 x 80	3,5	9 x A4
840/P	90 x 58	3	12 x 1/3 A4	840/TP	190	90 x 58	3	12 x 1/3 A4	840/DP	190	90 x 58	3	12 x 1/3 A4	840/QP	195	90 x 58	3,5	12 x 1/3 A4

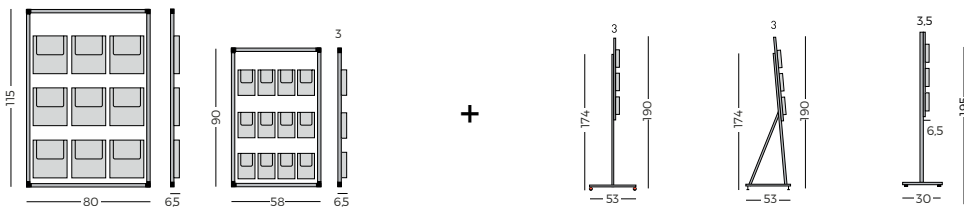

PORTAFOLLETOS MURALES Y CON PIÉ

ESP Portafolletos de metacrilato DIN A4 y 1/3 DIN A4 montados sobre tableros tapizados en téxtil y enmarcados con perfil de aluminio. Bajo presupuesto pueden fabricarse combinaciones con formatos de cajetines (Din A4, A5 y tríptico).

WALL AND FLOOR ANNOUNCEMENT BOARDS

ENG Methacrylate trays DIN A4 and 1/3 A4 mounted on aluminium anodised silver frame felt announcement boards. Special order boards with different trays in different formats (A4 and A5 and brochures) can be manufactured.

PORTE BROCHURES

FRA Porte Brochures en méthacrylate format A4 et 1/3 A4 montés sur des panneaux tapissés. Sur commande on peut fabriquer des combinaisons différents formats de cases (A4, A5 et triptyques).



EXPOPLAN

EXPOSITORES "SOFT" ANNOUNCEMENT BOARD "SOFT" PRESENTOIRS "SOFT"

8400



COLOR MELAMINA



/GR /AZ /VD /AM /NJ

REF	L	W	H	?
8400/1	120 x 80	2,7	9 x A4	
8400/2	80 x 80	2,7	6 x A4	
8300/1	120 x 80	2,7	15 x 1/3 A4	
8300/2	80 x 80	2,7	10 x 1/3 A4	

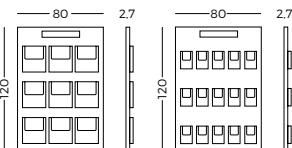

REF	L	W	H	?
8400/1/P	195	120 x 80	6,2	9 x A4
8400/2/P	195	80 x 80	6,2	6 x A4
8300/1/P	195	120 x 80	6,2	15 x 1/3 A4
8300/2/P	195	80 x 80	6,2	10 x 1/3 A4

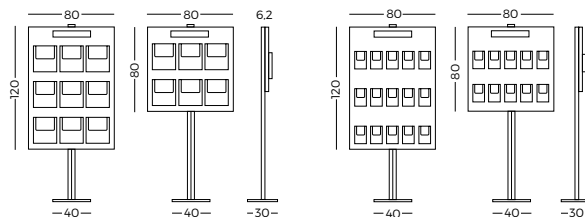

REF	L	W	H
Q/810/A	195	30 x 40	7 x 3,5
Q/810/B	145	30 x 40	7 x 3,5

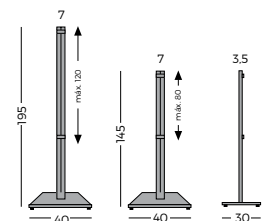

EXPOSITORES "SOFT"

ESP La gama de expositores forrados en melamina está disponible en formato mural en 2 tamaños y 2 formatos de portafolletos a elegir: DIN A4 y 1/3 DIN A4. Gracias a las múltiples combinaciones son el complemento ideal para el equipamiento de oficinas, recepciones, halls, etc...

ANNOUNCEMENT BOARD "SOFT"

ENG Range of board wall fixation in melamine, available in 2 different sizes and 2 of document holder, A4 and 1/3 of A4. This is the ideal product for hall, building entrance...

PRESENTOIRS "SOFT"

FRA Gamme de présentoir sur piétement mural en mélamine tapissé, disponible en 2 dimensions et deux formats de porte brochure A4 et 1/3 de A4. Créez votre composition pour une information visible dans les halls, couloirs, accueils...



2000

SISTEMA DE **CABLES Y TENSORES**
 CABLE AND **TENSION SYSTEM**
 SYSTÈME DE **CABLE ET POCLETTE**

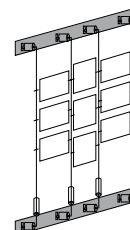
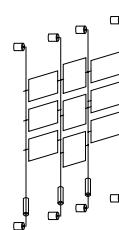
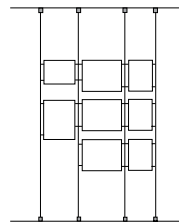

SISTEMA DE CABLES Y TENSORES

ESP Sistema de información de cables y tensores multifuncional. Mediante cables, carpetas de metacrilato y pinzas se puede componer el diseño deseado. Disponible en varios formatos y acabados.

CABLE AND TENSION SYSTEM

ENG Multifunctional cable and tension displaying system. You can create your own design by disposing cables, methacrylate folders and pincers from the ceiling to the floor, or ceiling-suspended. Available in different formats and finishes.

SYSTÈME DE CABLE ET POCLETTE

FRA Information, publicité ou décoration sur câble acier, pinces, tablettes et pochettes en méthacrylate. Composez votre vitrine a votre image.

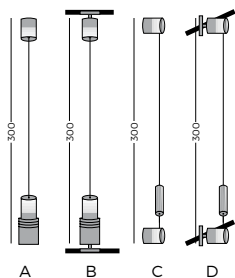

CABLES Y TENSORES

REF	L
A 2003/TS	300
B 2003/TSC	300
C 2003MM	300
D 2003/MMC	300

ESP Conjunto formado por 1 pieza fija a techo, pared o rail en la parte superior, cable de acero de 3 m y pieza tensora inferior.

ENG Cables can be fitted to suit all requirements - for wall to wall, floor to ceiling. Length: 3m. Cables secured to an end stop.

FRA Kit composé de 1 support fixation au plafond, mur ou rail, 1 câble en acier 3 m., et un tendeur inférieur.

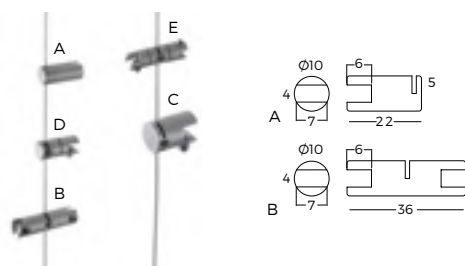

PINZAS DE SUJECCIÓN

REF	L
A 2000/2	0.4
B 2000/3	0.4
C 2000/4	0.8
D 2000/5	0.4
E 2000/6	0.4

ESP Pinzas mediante las cuales se sujetan las carpetas o estantes al cable tensor. Disponibles en múltiples formatos.

ENG Single sided or double sided support grips to hold panels, shelves or boxes. Either fixed or rotating.

FRA Pincettes de fixation permettant la liaison du câble avec les pochettes porte-visuel, tablettes ou boîtes.

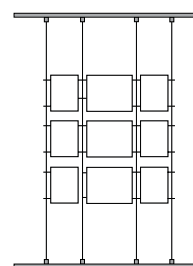
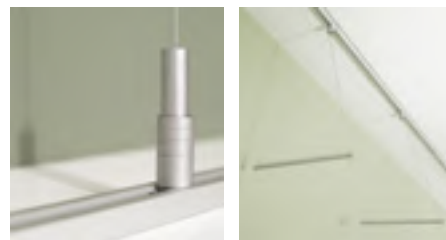

RAIL DE DESPLAZAMIENTO

REF	L
A 2001/C	2.5 x 100
B 2002/C	2.5 x 200
C 2003/C	2.5 x 300

ESP Perfil de aluminio anodizado. Se atornilla a techo, suelo o pared, y en su carril se fija el tensor. Permite desplazarse a der. e izq.

ENG Anodised aluminium finish. Screw fixing into ceiling and/or floor and/or wall. The tensor allows the sliding to the left or right.

FRA Finition aluminium anodisé. Fixation au plafond, au sol, u au mur, vis fournie. Il permet de déplacer librement l'ensemble des câbles.

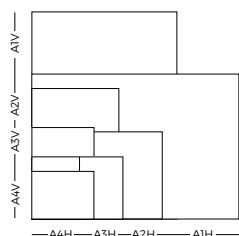

CARPETAS

REF	L	?
ST/A4/V	30 x 23.5	A4 - V
ST/A4/H	21 x 32.5	A4 - H
ST/A3/V	42 x 32.5	A3 - V
ST/A3/H	30 x 44.5	A3 - H
ST/A2/V	59 x 42	A2 - V
ST/A2/H	42 x 59	A2 - H
ST/A1/V	85 x 59	A1 - V
ST/A1/H	60 x 84	A1 - H





E-CLIP

SISTEMA DE CABLES Y TENSORES "E-CLIP"
 "E-CLIP" CABLE AND TENSION SYSTEM
 SYSTEME DE CABLE ET POCLETTE "E-CLIP"

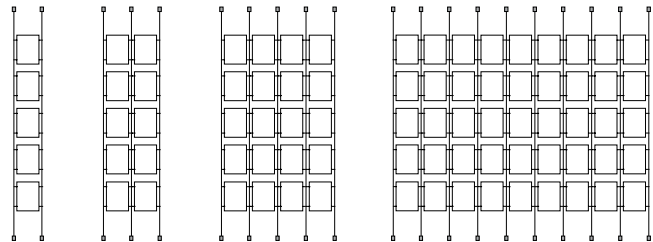
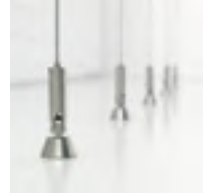

SISTEMA DE CABLES Y TENSORES "E-CLIP"

ESP Sistema de cables y tensores con carpetas de metacrilato transparente con nuevo sistema E-CLIP que permite intercambiar y mover de arriba/ abajo las carpetas sin necesidad de herramientas y en pocos segundos.

"E-CLIP" CABLE AND TENSION SYSTEM

ENG Multifunctional cable and tension display system. Thanks to the new grip E-CLIP it will be easy and fast to move your composition without need of special tools.

SYSTEME DE CABLE ET POCLETTE "E-CLIP"

FRA Information, publicité ou décoration sur câble en acier et pincettes. Le nouveau système de pincettes E-CLIP permet de moduler facilement et sans outils votre composition.

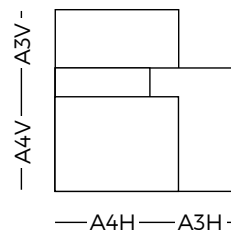
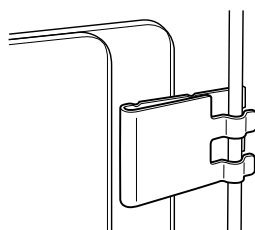
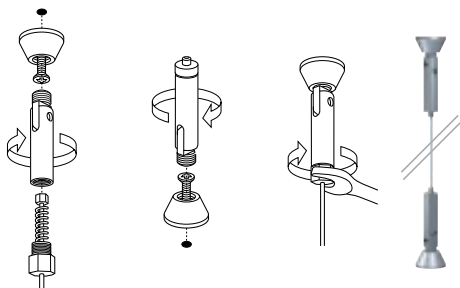
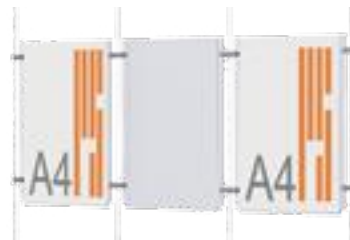

CABLES

REF | |

2102 400 0.3



PINZA

REF L

2101 2 x 3



CARPETAS

REF L ?

2100/A4/V 30 x 23.5 A4 - V
 2100/A4/H 21 x 32.5 A4 - H
 2100/A3/V 42 x 32.5 A3 - V
 2100/A3/H 30 x 44.5 A3 - H



5x

+



2x

+



20x

+



5x

+



4x

=

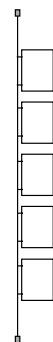

KIT DE PIEZAS

ESP Kit de piezas para el montaje de una columna E-CLIP.

ESP Pieces kit for one E-CLIP column.

ESP Kit de pièces pour le montage d'une colonne E-CLIP.

REF |

2100/KIT/I 400





TEN

BASTIDOR MÓVIL
ALUMINIUM FRAME
CADRE AUTO-PORTANT

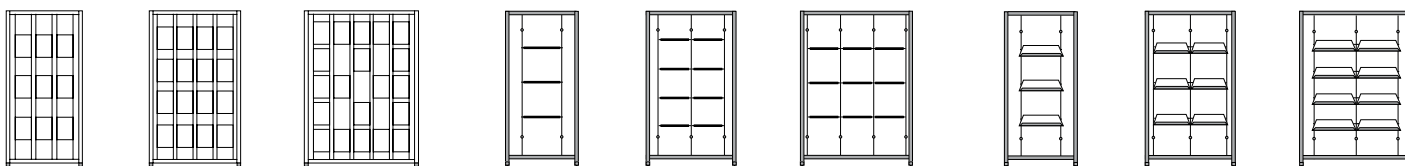

BASTIDOR MÓVIL "TEN"

ESP Sistema de cables sobre bastidor "Ten" fabricado en aluminio anodizado y pié "Y2" de fundición, provisto de ruedas o niveladores, que permite de manera rápida montar y desplazar el conjunto al espacio deseado. Ideal para escaparates, exposiciones, etc...

ALUMINIUM FRAME "TEN"

ENG Display cabling system in anodized aluminium with cast-iron "Y2" support, castors or jacks, total mobility and modular layout (cables, pockets, trays...)

CADRE AUTO-PORTANT "TEN"

FRA Système auto-portant en aluminium anodisé avec piétement "Y2" en fonte, avec roulettes ou verins, mobilité totale et configuration modulable (cables, pochettes, tablettes...).

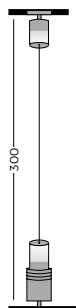

TENSOR
REF

2003/TSC 300

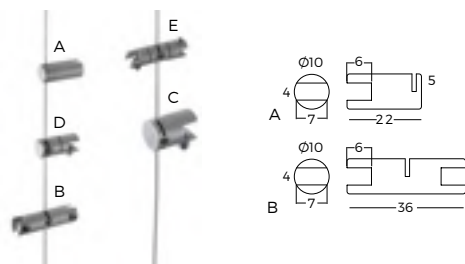

PINZAS DE SUJECIÓN

REF

A	2000/2	0.4
B	2000/3	0.4
C	2000/4	0.8
D	2000/5	0.4
E	2000/6	0.4



KIT DE PIEZAS

REF

A	TN/90/R	TN/90/N	212 x 90	5	3
B	TN/90/XF/R	TN/90/XF/N	212 x 90	5	3
C	TN/110/R	TN/110/N	212 x 110	5	4
D	TN/110/XF/R	TN/110/XF/N	212 x 110	5	4
E	TN/150/R	TN/150/N	212 x 150	5	5
F	TN/150/XF/R	TN/150/XF/N	212 x 150	5	5



KIT DE PIEZAS

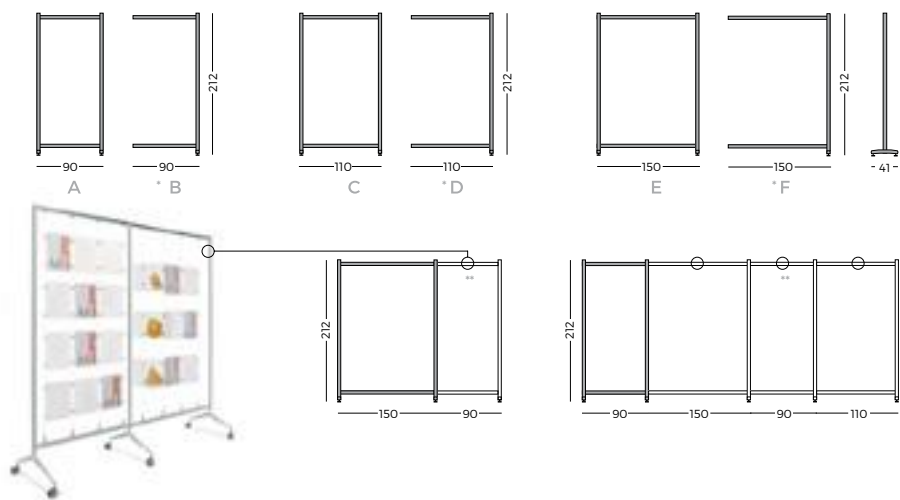



Q-T

POSTE DE INFORMACIÓN
INFO SYSTEM
BARRE D'INFORMATION

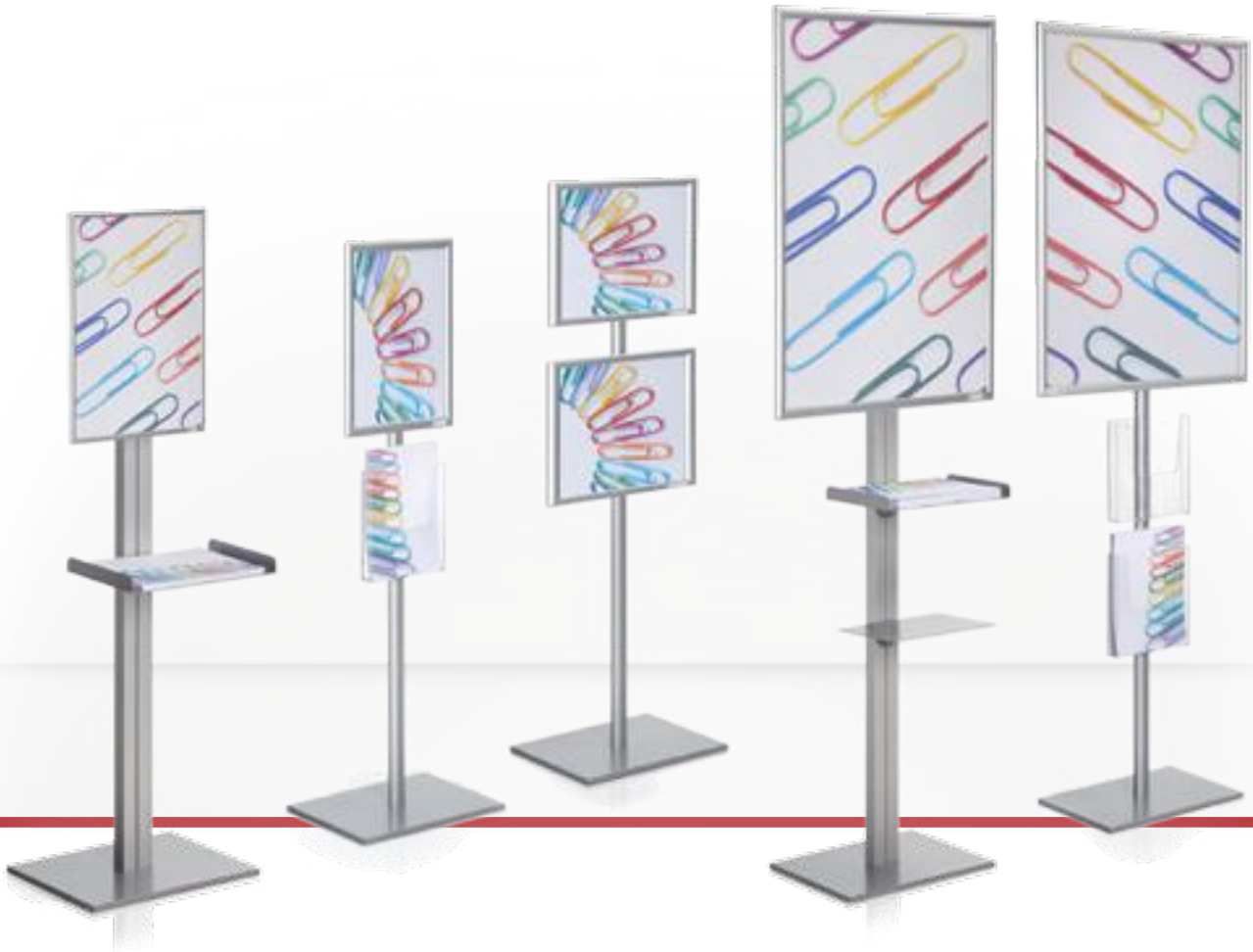
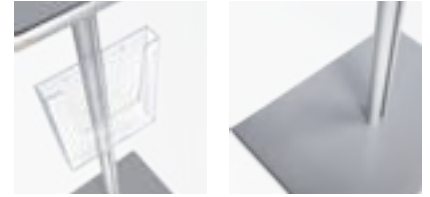

REF	↑	?
Q/198	95	30 x 40
Q/199	150	30 x 40
Q/200	195	30 x 40
Q/201	225	30 x 40

*No incluye accesorios

REF	↑	?
T/198	95	30 x 40
T/199	150	30 x 40
T/200	195	30 x 40
T/201	225	30 x 40

*No incluye accesorios

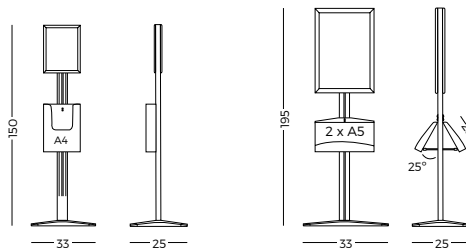

POSTE DE INFORMACIÓN "QUADRA"

ESP Sistema de exposición compuesto de un perfil de aluminio anodizado plata mate vertical, con base metálica cuadrada pintada en color gris. El perfil tiene dos ranuras sobre las que podemos aplicar diferentes accesorios, pinzas, portafolletos, etc.

INFO SYSTEM "QUADRA"

ENG Display system composed of a vertical matt silver aluminum anodised profile with a metallic square base painted in grey. The profile has 2 slots to be fitted with accessories like grips, document holders, etc. Ideal for congresses, exhibitions, sale points, etc..

BARRE D'INFORMATION "QUADRA"

FRA Système d'exposition composé d'une barre verticale en aluminium anodisé de couleur argent avec un socle carré en métal de couleur gris. La barre est rainurée sur ses 2 cotés opposés pour y fixer différents accessoires, pinces, portes brochures ou dépliant.

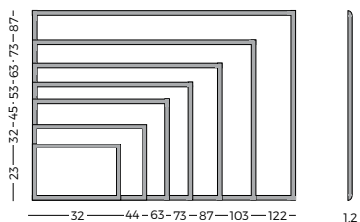

MARCO

REF	L	H	±	?
850/I/M0	87 x 122	82 x 117	1.2	A0
850/I/M1	63 x 87	57 x 82	1.2	A1
850/I/M2	45 x 63	40 x 58	1.2	A2
850/I/M3	73 x 103	68 x 98	1.2	70 x 100
850/I/M4	53 x 73	48 x 68	1.2	50 x 70
850/I/M5	32 x 44	42 x 29.7	1.2	A3
850/I/M6	23 x 32	21 x 29.7	1.2	A4

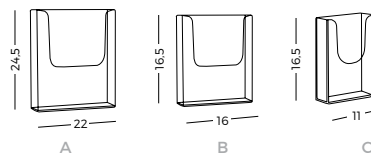

DISPLAY

REF	L	H	?
A4/M	24,5 x 22	3,5	A4
A5/M	16,5 x 16	3,5	A5
A4/3/M	16,5 x 11	3,5	1/3 A 4

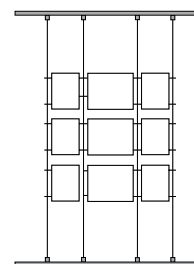

BANDEJA

REF	L
Q/2205	22 x 35

PERSONALIZACIÓN

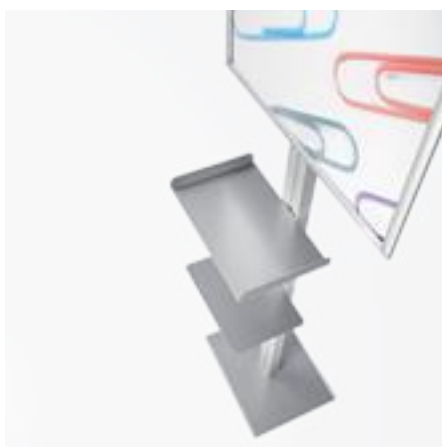



880

PANELES REJILLA
GRID PANELS
PANNEAUX GRILLE

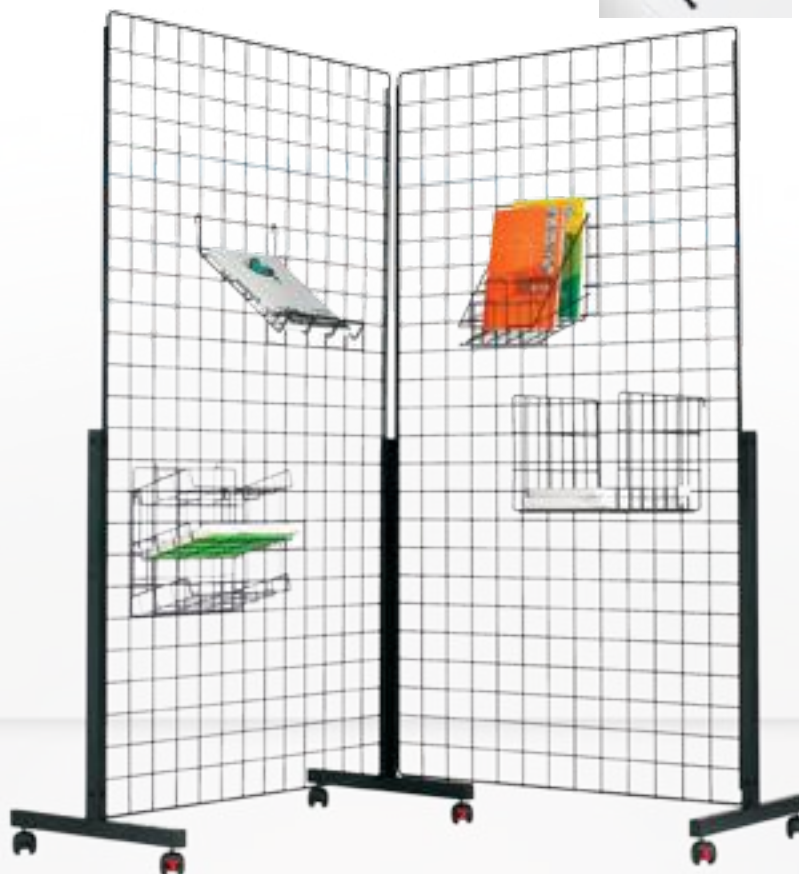
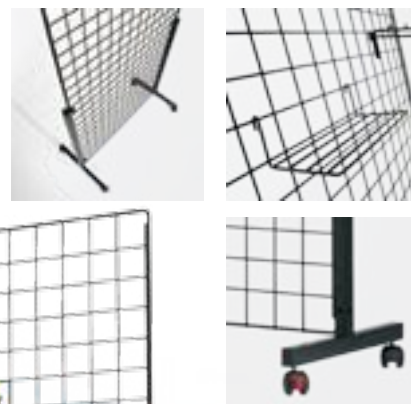

REJILLA

REF	L	- -
880	180 x 100	0.5

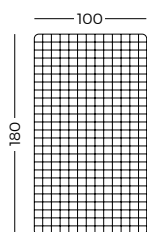

PIE

REF	L	- -
881	95 x 50	4



ACCESORIOS

REF	L	- -
8801	9,5 x 30 x 14	0.5
8802	35 x 22 x 5	0.5
8803	5 x 27 x 38	0.5
8804	29,5 x 22 x 24	0.5
8805	34,5 x 33 x 18	0.5
8808	9,5 x 3 x 27	0.5
8811	27 x 28 x 35	0.5

PANELES REJILLA

ESP Paneles rejilla metálicos de color negro, contruidos con varilla de hierro de 0,5 cm. formando una malla de 7 cm. Puede colgarse a la pared o montarse con pies forma "T" con ruedas. Sobre el panel podemos situar una extensa gama de accesorios.

GRID PANELS

ENG Black metallic grid panels which can be hung on walls or on "T" support frame (with castors). Black metallic stems have a diameter of 0,5 cm. and formed a 7 cm. net. Place a large range of accessories (also made with thin metallic stems).

PANNEAUX GRILLE

FRA Panneaux grille noir métallique en fer 0,5 cm. formant une cloison de 7 cm. Grande flexibilité de configuration. Fixation murale ou sur piètement "T" avec roulettes. Sur les panneaux on peut fixer très facilement une gamme étendue d'accessoires.

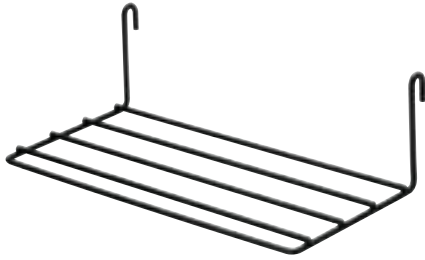

REF 8801 Estante plano
Straight shelf
Étagère plate



REF 8801 Estante vertical
Vertical shelf
Étagère verticale

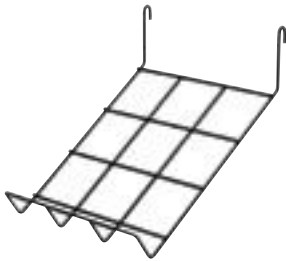

REF 8801 Estante plano
Straight shelf
Étagère plate

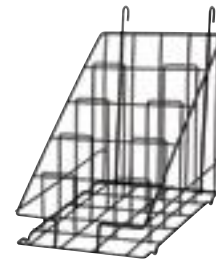

REF 8801 Revistero vertical
Vertical magazine rack
Porte-revues verticale

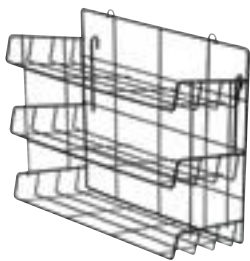

REF 8801 Triple estante plano
Triple straight shelf
Triple étagère plate



REF 8801 Gancho recto
Wire hood
Crochet droit

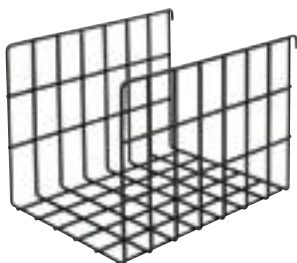

REF 8801 Cesto multifunción
Multifunction basket
Corbeille multifonctions



DISPLAY

PORTAFOLLETOS DE METACRILATO DOCUMENT HOLDERS PORTE-BROCHURES MÉTHACRYLATE



REF L uts./ box

H/50 10 x 20 50



REF	L	H	box	uts./ box
A4/V3	33 x 22	3,5	A4/V3/5	4
A4/S	30 x 22	3,5	A4/S/10	20
A4/M	24,5 x 22	3,5	A4/M/10	30

REF	L	H	box	uts./ box
A5/V3	23 x 16	3,5	A5/V3/5	12
A5/S	20 x 16	3,5	A5/S/10	40
A5/M	16,5 x 16	3,5	A5/M/10	45

REF	L	H	box	uts./ box
A4/S/V3	23 x 11	3,5	A4/S/V3/5	20
A4/S/S	20,5 x 11	3,5	A4/S/S/10	50
A4/S/M	16,5 x 11	3,5	A4/S/M/10	60

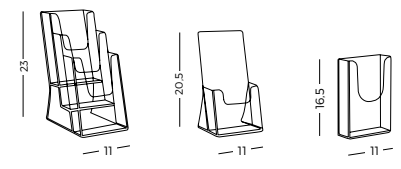
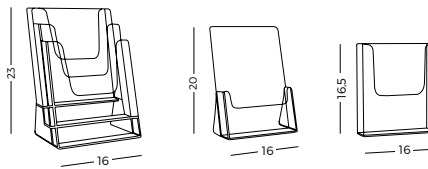
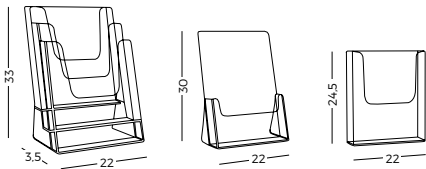

PORTAFOLLETOS DE METACRILATO

ESP Expositores para folletos DIN A4 fabricados en metacrilato transparente de alta resistencia. La diversidad de acabados; mural, sobremesa simple y sobremesa triple, permiten obtener un perfecto soporte para cada necesidad.

DOCUMENT HOLDERS

ENG High resistant transparent methacrylate document holders. Format A4. Many different finishings: wall, table and triple table that allow you to display all types of documents such as catalogs, brochures, cards for every need, etc.

PORTE-BROCHURES MÉTHACRYLATE

FRA Porte-Brochures A4 fabriqués en méthacrylate transparent de haute résistance. Gamme très étendue de finitions: usage mural, usage comptoir simple et triple pour tous les besoins.



EXPOPLAN

DISPLAYS DE ACRÍLICO
ACRYLIC DISPLAYS
PORTE-VISUELS ACRYLIC

DISPLAY



REF	L	?	□
BL/EX/0012	29,7 x 21	A4	V
BL/EX/0013	21 x 29,7	A4	H
BL/EX/0014	21 x 14,8	A5	V
BL/EX/0015	14,8 x 21	A5	H
BL/EX/0016	14,8 x 10,5	A6	V
BL/EX/0017	10,5 x 14,8	A6	H
BL/EX/0018	21 x 10,5	1/3 A4	V
BL/EX/0019	10,5 x 21	1/3 A4	H

REF	L	?	□
BL/EX/0032	29,7 x 21	A4	V
BL/EX/0033	21 x 29,7	A4	H
BL/EX/0034	21 x 14,8	A5	V
BL/EX/0035	14,8 x 21	A5	H
BL/EX/0036	14,8 x 10,5	A6	V
BL/EX/0037	10,5 x 14,8	A6	H
BL/EX/0038	21 x 10,5	1/3 A4	V
BL/EX/0039	10,5 x 21	1/3 A4	H

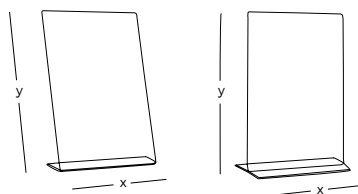

DISPLAY DE ACRÍLICO

ESP Gama de portadocumentos fabricados en acrílico transparente de alta resistencia. Disponibles en formato "T" y "L" y cada uno de ellos en tamaño A4, A5, A6 y 1/3 de A4 tanto en formato vertical como en horizontal.

DISPLAYS ACRYLIC

ENG Range document holder made of high strength transparent acrylic. Available as "T" and "L" and each of them in A4, A5, A6 and 1/3 of A4 format both vertically and horizontally.

PRESENTOIRS "SOFT"

FRA Gamme de supports et porte-documents en acrylique transparent de haute résistance. Disponible en "T" et "L" et disponibles en formats A4, A5, A6 et 1/3 de format A4 à la fois verticalement et horizontalement.

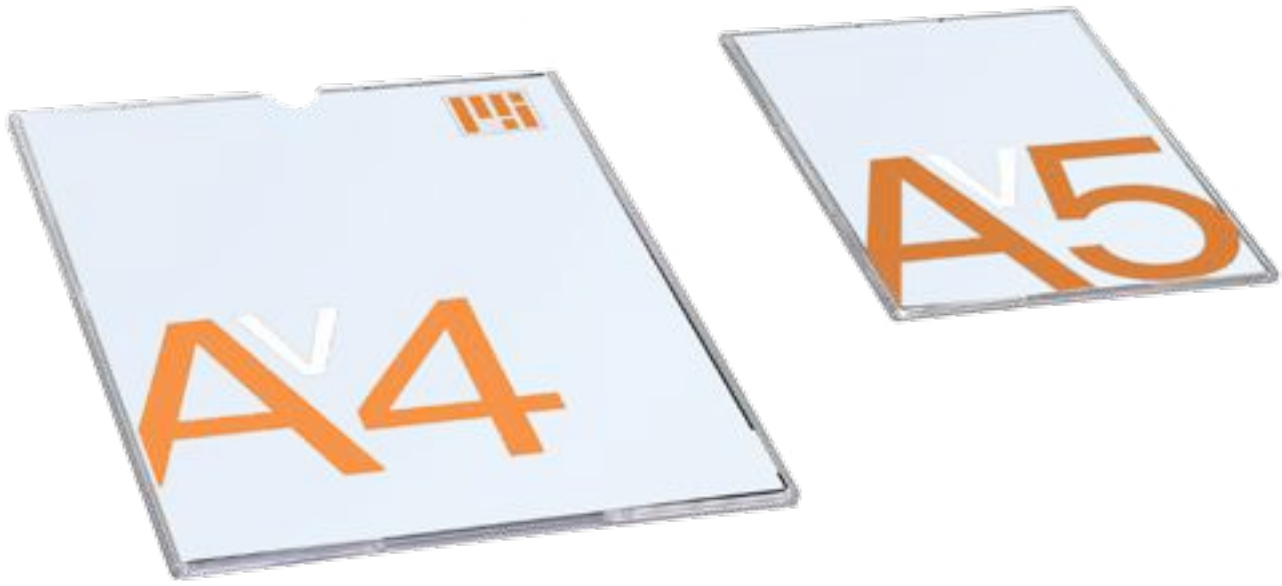

REF	L	H	box	uts./ box
-----	---	---	-----	-----------

PF/A4/M	30,5 x 22	0,5	PF/A4/M/10	10
---------	-----------	-----	------------	----

PF/A5/M	22 x 16	0,5	PF/A5/M/10	10
---------	---------	-----	------------	----

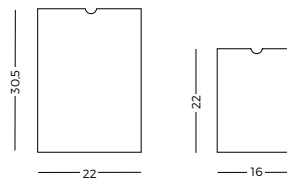

DISPLAY ACRYLICS

ESP Displays portafolletos fabricados en acrílico transparente de alta resistencia. La diversidad de acabados; mural, sobremesa y sobremesa con tríptico, permiten obtener un perfecto soporte para cada necesidad.

DISPLAY ACRYLICS

ENG High resistant transparent acrylic document holders. Many different finishings: wall, table and triple table that allow you to display all types of documents such as catalogues, brochures, cards for every need.

DISPLAY ACRYLICS

FRA Porte Visuels fabriqués en acrylique transparent de haute résistance. Gamme très étendue de finitions: usage mural, usage comptoir simple et triple pour tous les besoins.



EXPOPLAN

PORTACARTELES CON BASE DE METACRILATO
METHACRYLATE DOCUMENT HOLDER
 PORTE-VISUELS MÉTHACRYLATE

DISPLAY



POSICIÓN VERTICAL

REF	L	H
PC/AL/A4V	29,7 x 21	8,2
PC/AL/A5V	21 x 14,8	8,2
PC/AL/A6V	10,5 x 14,8	8,2

POSICIÓN HORIZONTAL

REF	L	H
PC/AL/A4H	21 x 29,7	8,2
PC/AL/A5H	14,8 x 21	8,2
PC/AL/A6H	14,8 x 10,5	8,2

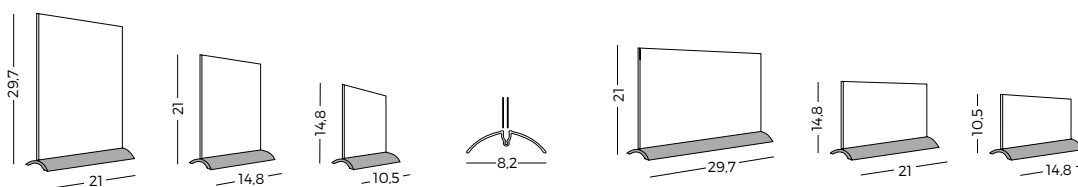

PORTACARTELES CON BASE DE ALUMINIO

ALUMINIUM DOCUMENT HOLDER

PORTE-VISUEL ET ALUMINIUM

ESP Expositor portacarteles fabricado en metacrilato transparente de alta resistencia y base de aluminio anodizada en plata mate. La diversidad de formatos: A4, A5 y A6 en formato vertical u horizontal, permiten obtener un perfecto soporte para cada documento.

ENG High-resistant transparent acryl document holders and silver anodised aluminium base. Format A4, A5, and A6, either vertical or horizontal. Ideal for the display of menus, at the restaurants, price lists, etc...

FRA Porte-visuel A4, A5 et A6 fabriqués en méthacrylate transparent de haute résistance avec socle aluminium. Usage vertical ou horizontal. Idéal pour des menus, listes de prix, soldes, etc...



CC-RAIL

RAIL PARA COLGAR CUADROS
RAIL FOR PICTURE HANGING
RAIL POUR ACCROCHER DES TABLEAUX

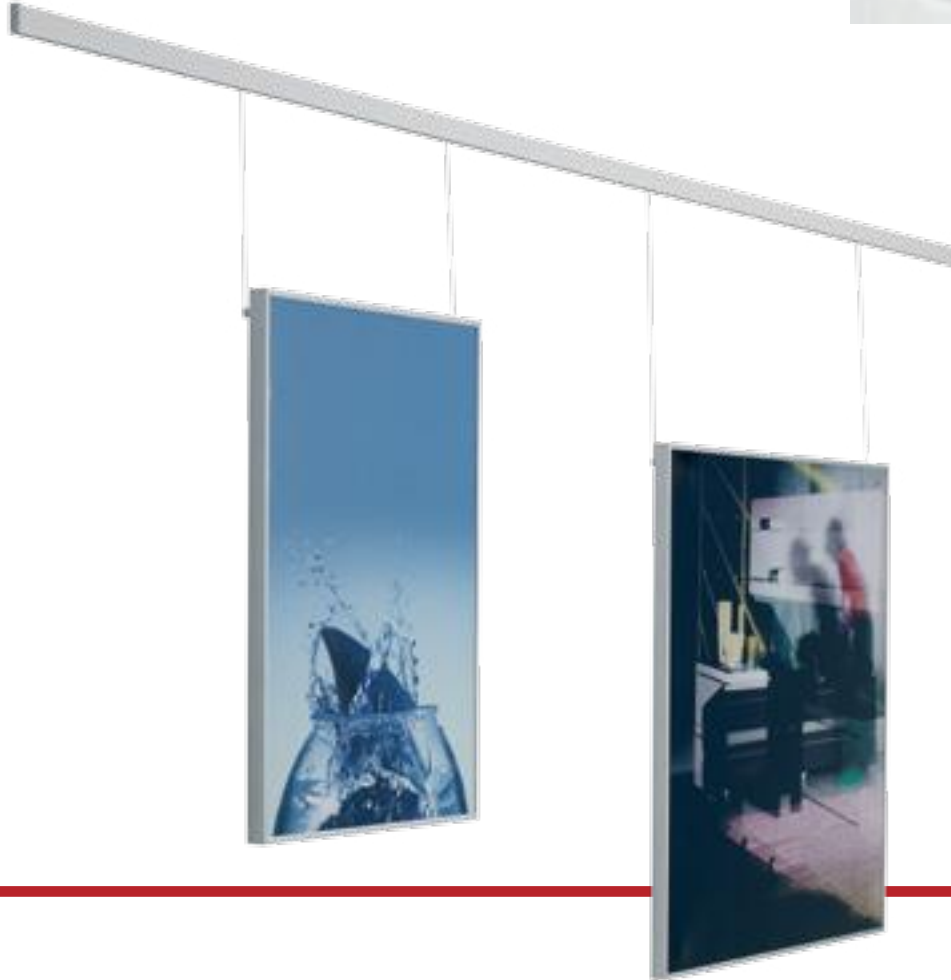

REF	┌	└
CC/150	3 x 200	1

REF	Cable	└
CC/1	2	1

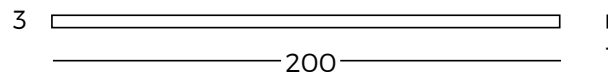

RAIL PARA COLGAR CUADROS

ESP Rail de aluminio mural color plata mate, para colgar cuadros. Permite cambiarlos sin tener que atornillarlos en la pared. Ideales para salas, galerías de arte, recepciones, etc. El kit de 200 cm. incluye un juego de 2 cables.

RAIL FOR PICTURE HANGING

ENG Aluminium rail system for hanging up pictures on the wall. Matt silver colour. It enables different layout without drilling holes on the wall or using screws. Ideal for rooms,... The fixation kit includes two iron hooks and a set of two 200 cm cables.

RAIL POUR ACCROCHER DES TABLEAUX

FRA Rail mural en aluminium pour suspendre et exposer des tableaux. Couleur argent mat. Ce système permet de changer facilement la composition de tableaux. Idéal pour des salles, des galeries d'art, des réceptions, etc



DISPLAY + BUZÓN
 DISPLAY + MAILBOX
 DISPLAY + BOÎTE AUX LETTRES

ES-ET-BZ



TARJETERO - PORTARRÓTULOS

REF	L	H	?	box	uts./ box
ES/1	6,2 x 21	4	5,7 x 20,5	-	-
ET/1	5,5 x 9,5	3,9	-	ET/1/10	40

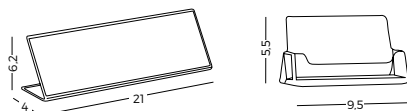

BUZÓN DESMONTABLE

REF	L
BZ/P	25 x 35

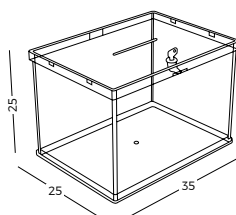

BUZÓN

REF	L
BL/EX/0070	20,5 x 20,5

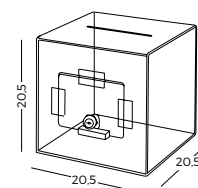

PORTARRÓTULOS, TARJETERO Y BUZÓN

ESP Porta tarjetas y portarrótulos de metacrilato de alta resistencia. El portarrótulos puede situarse en 2 posiciones. Buzón de sugerencias desmontable fabricado en metacrilato transparente de alta resistencia.

INFORMATION AND BUSINESS CARD HOLDER

ENG Made of high resistant methacrylate. The name holder can be placed in two different way. Suggestion box made of resistant transparent methacrylate.

SUPPORT INFORMATION ET CARTES DE VISITE

FRA Fabriqués en méthacrylate très résistant. Le support d'information peut se positionner de deux façons. Boîte à suggestions démontable en méthacrylate transparent très résistant.



CAJETINES METÁLICOS APILABLES
ATTACHABLE METALLIC TRAYS
CASIERS MÉTALLIQUES



REF	Top	Inside	Cover
DIN A4V	A4V/01	A4V/02	A4V/03
DIN A4H	A4H/01	A4H/02	A4H/03
DIN A5V	A5V/01	A5V/02	A5V/03
DIN A5H	A5H/01	A5H/02	A5H/03

REF	A	B	C
DIN A4V	30	24	1,5
DIN A4H	21,5	31,5	1,5
DIN A5V	21,5	16,5	1,5
DIN A5H	15	24	1,5

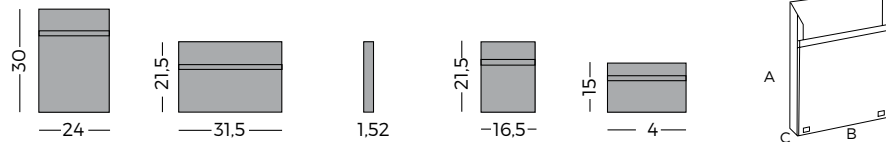

CAJETINES METÁLICOS APILABLES

ESP Cajetines apilables metálicas compuestas de 3 piezas que permiten instalarse en bloques (formato vertical u horizontal). Disponibles en Din A4 y Din A5, son el soporte adecuado para situar documentos. Ref. /01 Soporte pared, /02 Intermedio, /03 Tapa final.

ATTACHABLE METALLIC TRAYS

ENG Attachable metallic trays composed by 3 independent pieces that can be joined as blocks horizontally and vertically. Available in Din A4 and Din A5. Suitable for all kinds of documents: mail, cards, files, pamphlets, etc. Ref. /01 wall support, /02 Middle Tray, /03 Ending.

CASIERS MÉTALLIQUES

FRA Corbeille en métal superposable et juxtaposable. Très facile à monter. Compartiments modulables qui s'accrochent l'un à l'autre. Dimensions de la corbeille: DIN A4 et DIN A5. Réf.: /01 Support au mur, /02 Intermédiaire, /03 Pièce final.



PLANNING PORTAFICHAS
CARD PLANNER
PLANNING À FICHES

301-303-319



PORTAFICHAS

REF	L	H	?
301/60	72 x 12	1	60
303/60	72 x 6	1	60
301/40	52 x 12	1	40
303/40	52 x 6	1	40

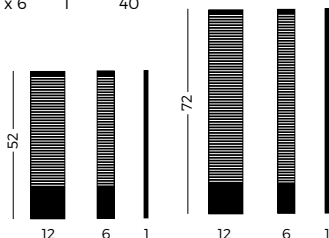

FICHAS

REF	L	?
3001	13,5 x 12	50
3003	10 x 6	50

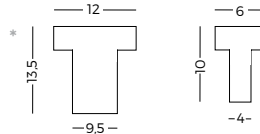

TARJETAS MAGNÉTICAS

REF	L	H	?
319	75 x 11,5	1,5	25

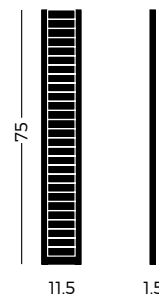

PLANNING PORTAFICHAS

ESP Portafichas para fichas en forma "T" de cartulina, intercambiables y ampliables mediante la guía de sujeción a pared Ref. 06. Disponibles en 2 formatos (6 ó 12 cm.), y dos tamaños (40 ó 60 fichas) respectivamente. Fichas 3003 y 3001 disponibles en 10 colores.

CARD PLANNER

ENG Card planner for "T" cards. Extendable through a wall subsection track placed at the base of the card planner (Ref. 06). Available in 2 formats (6 or 12 cm.) and 2 sizes (40 or 60 cards) respectively. Cards 3003 and 3001 are available in 10 different colours.

PLANNING À FICHES

FRA Planning pour fiche en T en carton et de couleurs (10 couleurs). Composez facilement votre système, sur 2 formats de 6 ou 12 cm et deux dimensions de fiches 40 ou 60.

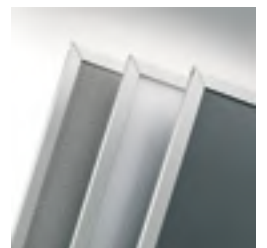

05

MODULPLAN

MOBILIARIO AUXILIAR
AUXILIAR FURNITURE
MOBILIER AUXILIAIRE



6000

PAPELERA **BASIC**
BASIC BINS
 CORBEILLES **BASIC**



COLOR PAPELERA



STANDARD /NG /BL

REF	L	L
6001	31 x 21,5	12
6002	31 x 25,5	16
6003	39,5 x 29,5	27

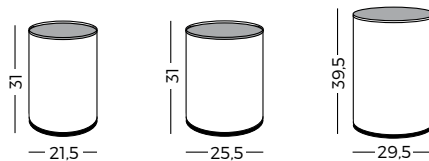

PAPELERA BASIC 6000

ESP Gama de papeleras metálicas lisas pintadas epoxi, provistas de aro inferior de PVC. Disponibles en 12, 16 y 27 litros. Color standard gris RAL 7035. Bajo pedido ver gama de colores.

BASIC BINS 6000

ENG Smooth metal wastebaskets Range epoxy painted, fitted with PVC bottom ring. Available in 12, 16 and 27 liters. Standard colour gray RAL 7035. Ask us for a special colour.

CORBEILLES BASIC 6000

FRA Gamme de corbeille à papier en métal époxy peint, équipée d'un anneau inférieure en PVC. Disponible en 12, 16 et 27 litres. Couleur standard gris RAL 7035. Consultez nous pour un coloris spécial.



MODULPLAN

PAPERAS
WASTEPAPER
CORBEILLE À PAPIER

PIENO



○ ● ●
/BL /NG STANDARD

●
/GR

PAPELERAS

REF	L	L
02P	37 x 25	18
03P	50 x 25	25

CUBETA

REF	L	+
C546/GR	21 x 14	20

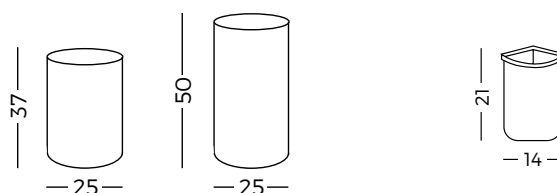

PAPELERA "PIENO"

ESP Gama de papeleras de chapa pintada epoxi color gris. Disponibles en 37 y 50 cm. de altura y 25 cm., de diámetro. Ideales para la oficina y el hogar. Opcional cubetas.

WASTEPAPER "PIENO"

ENG Range of wastepaper bins painted with grey epoxy, they are curved and fixed with chrome head screws. Available in 37 and 50 cm high and 25 cm diameter. Ideal for the office and home.

CORBEILLE À PAPIER "PIENO"

FRA Gamme de corbeilles en métal couleur gris époxy. Disponible en 37 et 50 cm de hauteur et en 25 et 50 cm de diamètre. Idéale pour les bureaux, etc...

MODULPLAN



CESTINI

PAPELERA METÁLICA
METALLIC WASTEPAPER BIN
CORBEILLE EN MÉTAL



COLOR PAPELERA



REF	L	L
A 6070	65,5 x 25,5	33
B 6071	65,5 x 25,5	33

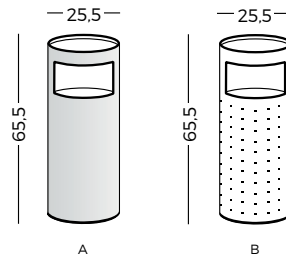

PAPELERA METÁLICA "CESTINI"

ESP Papelera metálica pintada en color gris ideal para centros comerciales y zonas de exterior. Apertura lateral por los dos lados y cenicero superior. Aro inferior de PVC.

METALLIC WASTEPAPER BIN "CESTINI"

ENG Wastepaper bin painted in grey. Ideal for shopping centers and outside. Bilateral opening and upper ashtray. Bottom PVC ring.

CORBEILLE "CESTINI" EN MÉTAL

FRA Corbeille en métal peint en gris. Idéale pour centres commerciaux et extérieur. Ouverture bilatérale et cendrier en partie supérieure. Anneau inférieur de pvc.



EXPOPLAN

PAPELERA METÁLICA
METALLIC WASTEPAPER BIN
CORBEILLE EN MÉTAL

SWING



COLOR PAPELERA



/BL STANDARD

REF	L	→	L
6030	65 x 31,5	26	41
6031	83 x 31,5	26	56

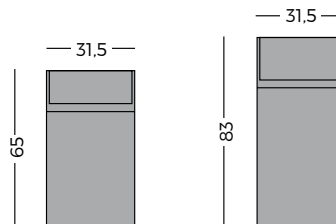

PAPELERA METÁLICA "SWING"

ESP Papelera con apertura batiente de mediana capacidad ideal para centros comerciales. Disponible en INOX bajo pedido para exterior. Disponible 2 tamaños. Cabezal basculante.

METALLIC WASTEPAPER BIN "SWING"

ENG Wastepaper bin with swing-open door of medium capacity. Ideal for shopping center. INOX version available for outdoors. 2 sizes available.

CORBEILLE "SWING" EN MÉTAL

FRA Corbeille avec ouverture battante de capacité moyenne. Idéale centres commerciaux. Version INOX disponible pour l'extérieur. Disponible en 2 dimensions.



6050

PAPELERAS DE PEDAL
 PEDAL BINS
 CORBEILLES À PÉDALE



COLOR PAPELERA



REF	∟	L
6050/I	32 x 21	5
6051/I	39 x 25	12
6052/I	45 x 30	20
6053/I	61 x 30	30

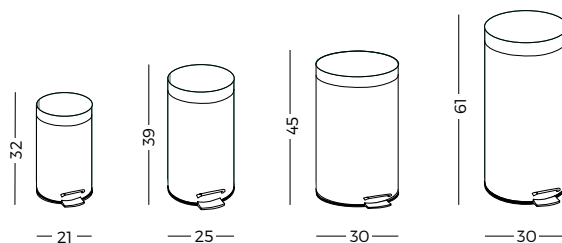

PAPELERAS DE PEDAL

ESP Gama de papeleras metálicas con apertura de pedal. Incorporan cubeta de plástico con asa y están disponibles en 5, 12, 20 y 30 litros. Acero inoxidable.

PEDAL BINS

ENG Range of metal bins with pedal opening. Incorporating plastic bucket and handle are available in 5, 12, 20, and 30 liters. Stainless steel.

CORBEILLES À PÉDALE

FRA Gamme de corbeilles métalliques avec ouverture par pédale. Un seau en plastique intérieur avec poignée est disponibles en 5, 12, 20 et 30 litres. Acier inoxydable.



MODULPLAN

PAPELERA DE **RECICLAJE**
RECYCLE BINS
 CORBEILLE DE **RECYCLAGE**

6045



COLOR PAPELERA



/AZ /VD /AM

REF	↑	L	L
6045	81	26 x 36,5	76

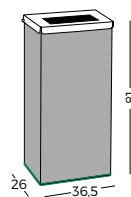
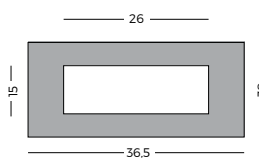

PAPELERA DE RECICLAJE

ESP Papelera de reciclaje gris de 76 litros, con tapa abatible y aro interior para bolsa. Tapa superior disponible en 3 colores de reciclaje básicos. Ideal para oficinas, centros comerciales, etc...

RECYCLE BINS

ENG Recycle Bin 76 liters grey colour, with hinged lid and inner ring for bag. Top cover available in 3 basic colours recycling. Ideal for offices, shopping malls, etc ...

CORBEILLE DE RECYCLAGE

FRA Corbeille de recyclage de 76 litres, avec couvercle à charnière et bague intérieure pour le sac. Le couvercle est disponible en 3 couleurs de base de recyclage. Idéale pour les bureaux, les centres commerciaux...



PUSH

PAPELERAS
WASTEPAPER
CORBEILLE À PAPIER



REF	L	L
PUSH/GA	88 x 33	50
BIG/PUSH/GA	94 x 40	88

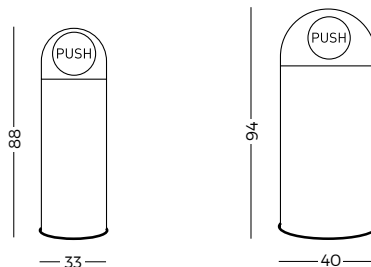

PAPELERAS CONTAINER "PUSH"

ESP Papelera container con apertura redonda tipo "Push" con cierre retráctil, fabricadas en chapa pintada epoxi gris. Incorpora en su interior estructura de varilla para sujeción de bolsa de plástico.

"PUSH" WASTEPAPER

ENG Push waste collectors with round self-closing access flap. They are painted with grey epoxy. An inner bar structure for fastening a plastic bag is included.

CORBEILLE À PAPIER "PUSH"

FRA Corbeille à ouverture ronde de type "Push". L'ouverture s'effectue par un mouvement de bascule. Fabriquée en tôle métallique laquée époxy couleur gris. Incluant à l'intérieur un support en métal pour mettre un sac en plastique.



MODULPLAN

CENICEROS PARA EXTERIOR
OUTDOOR ASHTRAYS
CENDRIERS D'EXTÉRIEUR

BL/MO



DE SUELO

REF	L	H	L
BL/MO/0052	100 x 45	25	4,43

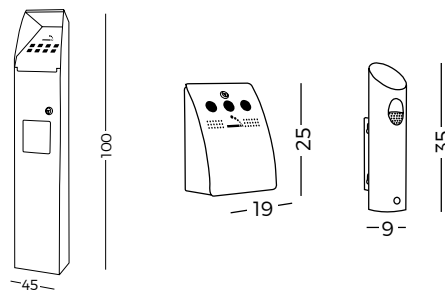

DE PARED

REF	L	H	L
A BL/MO/0050	25 x 19	21	1,48
B BL/MO/0051	35 x 9	25	0,68



CENICEROS PARA EXTERIOR

ESP Gama de ceniceros de exterior. 3modalidades a suelo o a pared todos ellos provistos con cerradura de seguridad. Ideal para situar en las entradas de espacios públicos y privados donde no está permitido fumar.

OUTDOOR ASHTRAYS

ENG Range of outdoor ashtrays. 3 models, for floor or wall all provided with security lock. Ideal for entries and in public or private spaces where smoking is not permitted

CENDRIERS D'EXTÉRIEUR

FRA Gamme de cendriers d'extérieurs. 3 modèles de sol ou mural tous fournis avec serrure de sécurité. Idéal pour les entrées dans les espaces publics et privés où fumer est interdit.



6120

PERCHEROS
COAT RACK
PORTE-MANTEAU



COLOR PERCHERO

STANDARD

REF	L	H	●
6120/3	10 x 41	2,5	3
6120/4	10 x 55	2,5	4
6120/6	10 x 85	2,5	6
6120/6R	24 x 81	2,5	6

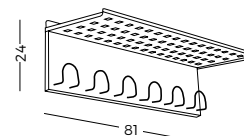
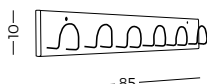
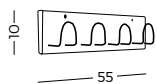
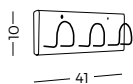

PERCHEROS

ESP Colección de percheros murales metálicos pintados epoxi gris. Diferentes tamaños y disponible en 3, 4 y 6 perchas. Ideales tanto como para el mundo de la oficina como el habitat.

COAT RACK

ENG Wall racks collection painted in grey epoxy. Different sizes and available in 3, 4 and 6 hangers. Ideal as to the world of office as the habitat..

PORTE-MANTEAU

FRA Gamme de portes manteaux métalliques finition en époxy gris. Différentes dimensions, avec 3, 4 et 6 crochets. Idéal pour les bureaux et l'habitat.

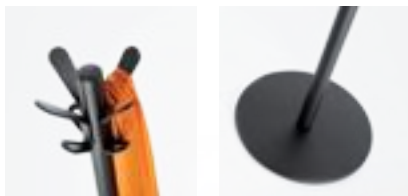

MODULPLAN

PERCHERO
COAT HANGER
PORTE-MANTEAU

ECO/T



COLOR PERCHERO



/NG /BL

REF L ●

EC/02 180 x 35 4 + 4

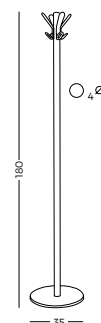

PERCHERO ECOT

ESP Perchero metálico de tubo redondo de ϕ 4 cm. y de gran ligereza y estabilidad gracias a su base. Disponible con 4 ganchos dobles en su parte superior y pintados en colores negro y blanco. Ideal para la oficina, y el habitat. Bajo demanda y según cantidad pueden solicitarse colores especiales.

ECOT COAT HANGER

ENG Coat hanger made of light metal circle tube ϕ 4 cm. and with a good stability thanks to its base. Available with 4 double hooks at the top and painted in black and white colours. Ideal for office, and habitat. In function of quantity you can ask for special colours.

PORTE-MANTEAU ECOT

FRA Porte-manteau en tube métal tube cercle ϕ 4 cm., léger et stable grâce à sa base. Disponible avec 4 crochets doubles en partie supérieures et peint en noir et blanc. Idéal pour le bureau et l'habitat. Sur demande et en fonction des quantités option de couleurs spéciales.



6110

PERCHERO DE PIÉ
COAT RACK
PORTE-MANTEAU SUR PIED



COLOR PERCHERO



/GR /NG

REF	↑	→	●
6110/GR	165	30	6
6110/NG	165	30	6

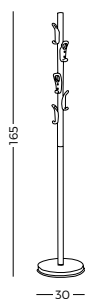

PERCHERO DE PIÉ

ESP Perchero de pie fabricado con tubo de acero pintado en epoxi negro o gris. Disponible en 6 colgadores para mantener tu área de trabajo ordenada. Su elegante diseño lo hace ideal tanto para oficina como para el habitat.

COAT RACK

ENG Coat stand made of steel tube painted in black or grey epoxy. Available in 6 hangers to keep your work area tidy. Its elegant design makes it ideal for both office and for the habitat.

PORTE-MANTEAU SUR PIED

FRA Portemanteau en tube acier et peinture époxy noir ou gris. Disponible avec 6 crochets. Son design élégant, le rend idéal pour le bureau et pour l'habitat.



MODULPLAN

PERCHEROS
COAT HANGER
PORTE-MANTEAU

6100



COLOR PERCHERO



STANDARD

REF | | ●

6100 177 38 8

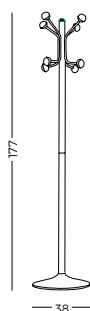

PERCHERO

ESP Perchero de pié metálico pintado epoxi gris. Provisos de 8 colgadores de bola. Ideal tanto como para el mundo de la oficina como el habitat.

COAT HANGER

ENG Coat hanger of gray epoxy painted metal foot. Armed with eight ball hangers. Ideal as to the world of office as the habitat...

PORTE-MANTEAU DEBOUT

FRA Porte-manteaux en époxy peint en gris et pied en métal. Armé de huit boules. Idéal pour les bureaux et l'habitat.



TEN

PERCHERO MURAL
WALL COAT-HANGER
PORTEMANTEAU MURAL



PERCHERO

REF	L	↑	⇄
TS/PER/MT	200 x 65	25	4,5
TS/PER/MX	200 x 62	25	4,5



BASTIDOR

REF	L	⇄	⇄
TS/BUR/R	174 x 120	53	4,5

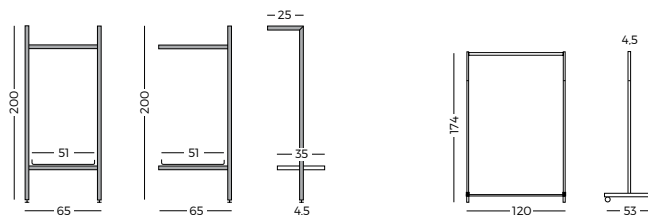

PERCHERO MURAL DE ALUMINIO "TEN"

ESP Perchero mural fabricado con perfil de aluminio pata mate TEN. Se fija a la pared mediante los brazos separadores y se apoya al suelo. Disponible kit de ampliación: Ref. TS/PER/M.

ALUMINIUM WALL COAT-HANGER "TEN"

ENG Coat hanger made from aluminium, fixed to the wall and floor. Hanging rod for hangers and lower tray for bags or helmets included. Extension kit available.

PORTEMANTEAU MURAL EN ALUMINIUM "TEN"

FRA Porte manteau mural en aluminium TEN. Un point de fixation mural et appui au sol sur piétement. Kit d'extension disponible. Barre de suspension pour cintres et tablette inférieure pour sacs et casques inclus.



MODULPLAN

PERCHERO CON RUEDAS
COAT-HANGER WITH CASTORS
PORTEMANTEAU AVEC ROULETTES

TEN



BASTIDORES

REF	L	↑	┆┆
TS/PER/R	174 x 120	53	4,5
TS/PER/RB	174 x 120	53	4,5

PERCHA

REF	L
PER/I	19 x 40

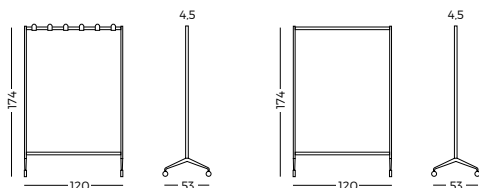

PERCHERO "TEN" CON RUEDAS

ESP Perchero con ruedas (2 con freno) fabricados con perfil de aluminio anodizado plata mate TEN. El perchero incluye 6 brazos dobles (12 perchas) y 2 bases de plexiglass blanco en la parte inferior.

METALLIC COAT-HANGER "TEN" WITH CASTERS

ENG Coat hanger TEN made from anodized aluminium on casters with brakes. 6 double pegs (12 total) and 2 lower trays made from plexiglass.

PORTEMANTEAU "TEN" AVEC ROULETTES

FRA Portemanteau sur roulettes (dont 2 avec frein) en aluminium anodisé TEN. 6 patères doubles et 2 tablettes inférieures pour sacs et casques en plexiglass.



TEN

SISTEMA DE **ESTANTERÍA**
SHELF MODULAR SYSTEM
ETAGÈRE MODULAIRE SYSTEM



●
STANDARD

ALUMINIO

REF		--
TS/242/P	220	25

SOPORTES

REF		--
TS/242/SE	3	25

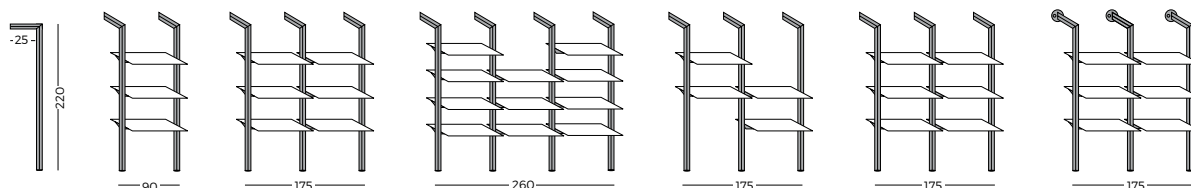

SISTEMA DE ESTANTERÍA "TEN"

ESP Perfilera de aluminio anodizada plata mate para equipar comercios, vestidores, oficinas, etc... Gracias a su modularidad permite confeccionar estantería de la medida deseada. Se compone de perfil vertical, juego de soportes graduable y estantes.

MODULAR SYSTEM "TEN"

ENG Modular shelf in anodized aluminium. Ideal for offices, shops, cloakrooms...(various layouts possible). Composed of a vertical profile with wall fixation and a set of brackets. Various colors and finishings.

ETAGÈRE MODULAIRE SYSTEM "TEN"

FRA Etagère modulaire en aluminium anodisé "Ten", idéale pour les bureaux, commerces, vestiaires... (nombreuses configurations possibles). Composée d'un profil vertical avec fixation murale, d'un jeu de pattes de fixation réglables, diverses finitions et couleurs.



ESTANTE PLANO

REF	L	-H-
214/EP/H1	35 x 81	1,6
214/EP/G1	35 x 81	1,6
214/EP/C1	35 x 81	1,6
214/EP/H	50 x 81	1,6
214/EP/G	50 x 81	1,6
214/EP/C	50 x 81	1,6

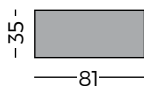

Con soporte incluido



ESTANTE INCLINADO

REF	L	-H-
TS/242/EI	35 x 66,5	0,2
214/EI/H	50 x 81	1,6
214/EI/G	50 x 81	1,6

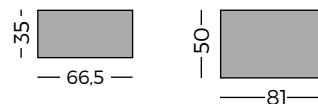

PERSONALIZACIÓN

ESP Combinación de diferentes materiales o acabados en una estructura.

ENG Different materials and finishes can be combined in one design.

FRA Combinaison de différents matériaux ou finitions sur une seule et même structure.





LIMIT

MAMPARA MODULAR
MODULAR PARTITION
 CLOISON MODULAIRE



A



B



/PI /PX /T/BL /T/GR /T/NG

MAMPARA

REF	L	--	- -
300/1/...	120 x 100	122	2
300/2/...	150 x 100	152	2
300/3/...	180 x 100	182	2

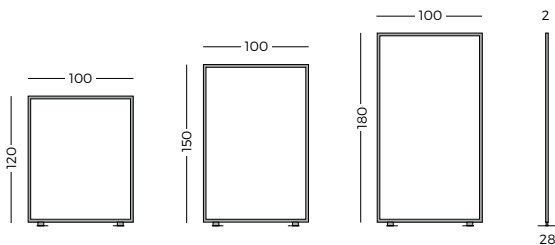

KITS DE UNIÓN

REF	L	⊙
A 300/K	2 x 5	2
B 300/K/4	5 x 5	4

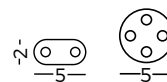

MAMPARA MODULAR "LIMIT"

ESP Mampara modular "Limit" fabricada con perfil de aluminio anodizado mate y pies trapezoidales metálicos pintados en gris. Su sistema de unión permite ser graduable y abrir y cerrar con la apertura de grados necesaria.

MODULAR PARTITION "LIMIT"

ENG Modular partition with aluminium structure and metallic supports. Different layouts possible: in a line or in staggered rows... Panels in ribbed plexy, grey metal or black laminated in relief.

CLOISON MODULAIRE "LIMIT"

FRA Cloison modulaire avec structure en aluminium et pieds métalliques. Modulable pour configurations en ligne, en quinconce... Panneaux en plexy canulé, métal gris ou laminé noir en relief.



PIZARRA

REF L -- +-|

300/1/PI	120 x 100	122	2
300/2/PI	150 x 100	152	2
300/3/PI	180 x 100	182	2



LAMINADO

REF L -- +-|

300/1/T/BL	120 x 100	122	2
300/1/T/GR	120 x 100	122	2
300/1/T/NG	120 x 100	122	2
300/2/T/BL	150 x 100	152	2
300/2/T/GR	150 x 100	152	2
300/2/T/NG	150 x 100	152	2
300/3/T/BL	180 x 100	182	2
300/3/T/GR	180 x 100	182	2
300/3/T/NG	180 x 100	182	2



POLICARBONATO

REF L -- +-|

300/1/PX	120 x 100	122	2
300/2/PX	150 x 100	152	2
300/3/PX	180 x 100	182	2



CREACIÓN DE ESPACIOS

ESP Crea espacios dentro de la oficina para poder crear un ambiente de trabajo adecuado.

ENG Design spaces within the office to creating a suitable work environment.

FRA Créez des espaces afin d'adapter et créer des ambiances de travail différentes.

ACABADOS

PIZARRA - /PI

POLICARBONATO - /PX

LAM. BLANCO - /T/BL

LAM. GRIS - /T/GR

LAM. NEGRO - /T/NG

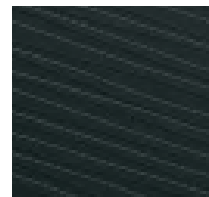
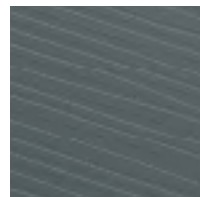
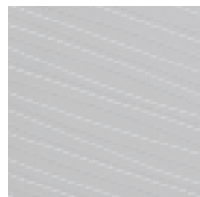
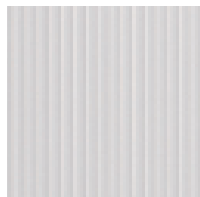
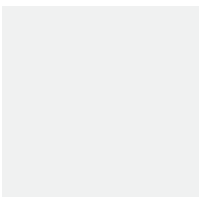



TEN-LIMIT

MAMPARA MODULAR
MODULAR PARTITION
 CLOISON MODULAIRE



ACABADO / COLOR TAPIZADO



/PI /PX /NG /BD /AZ /VD /GR /OC

REF L -- -||-

TL/150/...	150 x 100	175	4,5
TL/180/...	180 x 100	205	4,5

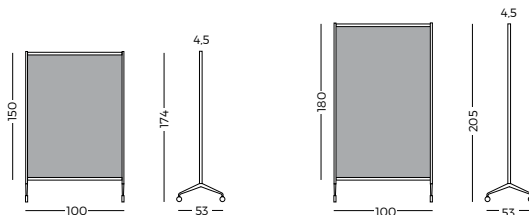

MAMPARA TEN-LIMIT MODULAR

ESP Sistema de mampara modular fabricada con perfil de aluminio color plata y estructura provista de pies de fundición con ruedas y freno. Disponible en pizarra blanca laminada rotulable, policarbonato acanalado y tapizada disponible en 6 colores.

TEN-LIMIT MODULAR PARTITION SYSTEM

ENG Modular partition system made of silver gray aluminium profile and a structure with cast feet fitted with wheels and brakes. Available with whiteboard laminated, corrugated polycarbonate and available in 6 colours of fabric.

TEN-LIMIT CLOISON MODULAIRE

FRA Système de cloison modulaire sur cadre en aluminium et pieds en fonte gris, équipés de roulettes et de freins. Disponible en finition tableau blanc stratifié, polycarbonate rainuré et disponible en 6 couleurs de tissus.

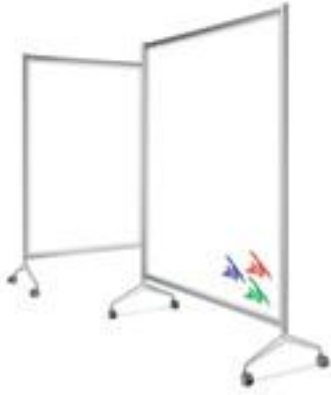

PIZARRA

REF L -- +-|+

TL/150/PI	150 x 100	175	4,5
TL/150/XF/PI	150 x 100	175	4,5
TL/180/PI	180 x 100	205	4,5
TL/180/XF/PI	180 x 100	205	4,5



TAPIZADO

REF L -- +-|+

TL/150/T	150 x 100	175	4,5
TL/150/XF/T	150 x 100	175	4,5
TL/180/T	180 x 100	205	4,5
TL/180/XF/T	180 x 100	205	4,5



POLICARBONATO

REF L -- +-|+

TL/150/PX	150 x 100	175	4,5
TL/150/XF/PX	150 x 100	175	4,5
TL/180/PX	180 x 100	205	4,5
TL/180/XF/PX	180 x 100	205	4,5



TAPIZADOS

NEGRO - /NG

BURDEOS - /BD

AZUL - /AZ

VERDE - /VD

GRIS - /GR

OCRE - /OC

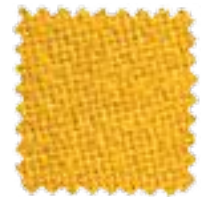

ACABADOS

PIZARRA - /PI

POLICARBONATO - /PX

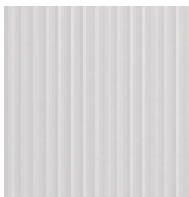
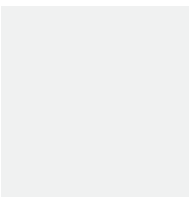



SCREEN

MAMPARA MODULAR
MODULAR PARTITION
CLOISON MODULAIRE



COLOR TAPIZADO



/GR /NG

REF	L	--	- -
sc/90/...	165 x 90	190	4,5
sc/110/...	165 x 110	190	4,5
sc/150/...	165 x 150	190	4,5

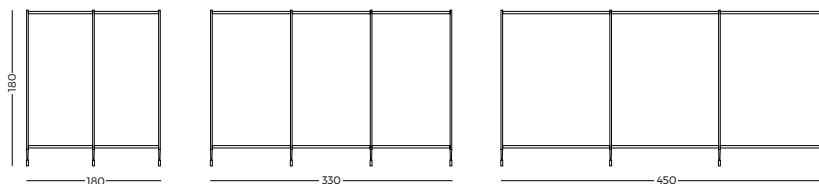

MAMPARA MODULAR "SCREEN"

ESP Mampara modular "Screen" fabricada con perfil de aluminio "Ten" y pies de fundición del sistema "Y2". Su sistema de unión abisagrabable, permite abrir y cerrar con la apertura de grados necesaria. Disponible con screen (tèxtil) negro, gris y personalizable.

ALUMINIUM PARTITION "SCREEN"

ENG Modular aluminium partition with "Y2" support. Different layouts possible: in a line, in zig-zag... Available with black, grey or customizable screen (canvas).

CLOISON MODULAIRE "SCREEN"

FRA Cloison modulaire "Screen" en profil aluminium "Ten" et piétement "Y2". Orientable pour configurations en ligne, en zig-zag... Disponible avec screen (toile) noire, grise et/ou personnalisable (sur demande).



TAPIZADO NEGRO

REF	L	↑	⇄
A SC/90/NG	165 x 90	190	4,5
B SC/90/XF/NG	165 x 90	190	4,5
C SC/110/NG	165 x 110	190	4,5
D SC/110/XF/NG	165 x 110	190	4,5
E SC/150/NG	165 x 150	190	4,5
F SC/150/XF/NG	165 x 150	190	4,5



TAPIZADO GRIS

REF	L	↑	⇄
A SC/90/GR	165 x 90	190	4,5
B SC/90/XF/GR	165 x 90	190	4,5
C SC/110/GR	165 x 110	190	4,5
D SC/110/XF/GR	165 x 110	190	4,5
E SC/150/GR	165 x 150	190	4,5
F SC/150/XF/GR	165 x 150	190	4,5

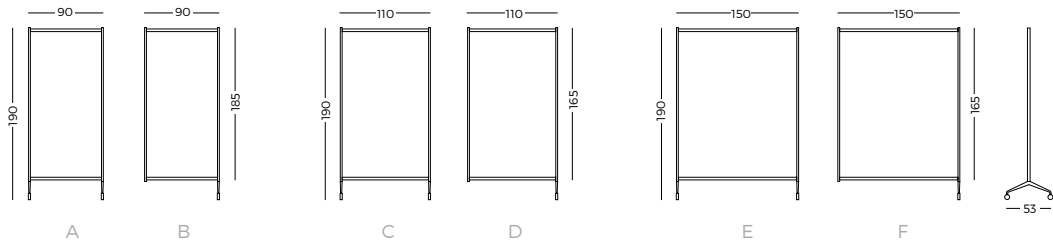

CREACIÓN DE ESPACIOS

ESP Crea espacios dentro de la oficina para poder crear un ambiente de trabajo adecuado.

ENG Design spaces within the office to creating a suitable work environment.

FRA Créez des espaces afin d'adapter et créer des ambiances de travail différentes.

TAPIZADOS

NEGRO - /NG

GRIS - /GR





750

MAMPARA MODULAR
MODULAR PARTITION
CLOISON MODULAIRE

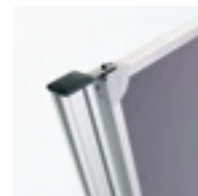

ACABADO / COLOR TAPIZADO



REF L H

750/... 120 x 150 3,5

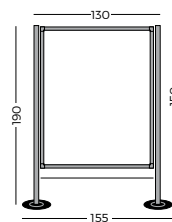
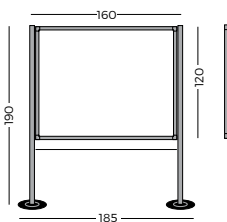

MAMPARA MODULAR

ESP Mampara modular muy ligera, construida con un núcleo central de nido de abeja, enmarcada con perfil de aluminio con cantoneras de color gris y tapizado en textil por ambos lados. Amplia gama de aplicaciones como: Exposiciones, ferias, convenciones, etc.

MODULATED FELT BOARDS

ENG Light modulated felt boards with aluminium frame, grey corners and honeycomb wood. Double-sided felt board. Variety of applications, such as expositions, fairs, conventions, etc... Boards are 120 x 150 cm. and you can mount the support vertically or horizontally.

CLOISONS MODULAIRES

FRA Cloison modulaire très légère fabriquée en carton nid d'abeille, avec encadrement en aluminium et coins en plastique gris. 120 x 150. Montage et transport facile. Idéale pour les expositions, séparations d'espaces, foires, conventions, etc...



TAPIZADO

REF	L	H
750/T/NG	120 x 150	3,5
750/T/AZ	120 x 150	3,5
750/T/BD	120 x 150	3,5
750/T/GR	120 x 150	3,5
750/T/VD	120 x 150	3,5
750/T/OC	120 x 150	3,5



CORCHO

REF	L	H
750/C	120 x 150	3,5



VARIOS

REF	L	H
A 750/MG	120 x 150	3,5
B 750/P	120 x 150	3,5



A - Melamina gris/Laminated grey
B - Pizarra laminada blanca/Laminated whiteboard

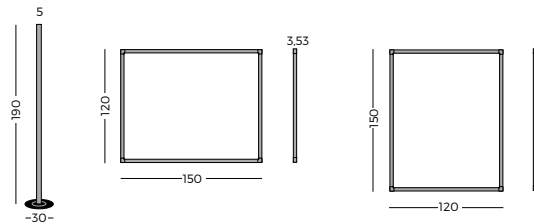

SOPORTE

REF	L	H
770/10	190 x 30	5



COMBINACIONES

Bajo pedido / Under order / Sous commande

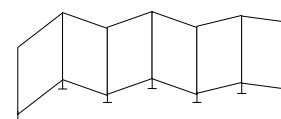
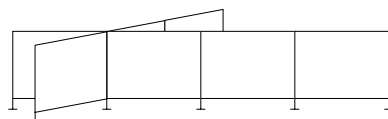
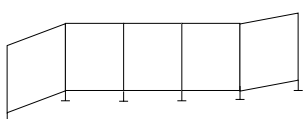



SEP

SEPARADOR DE ESCRITORIO
 DESKTOP SEPARATOR
 SÉPARATEURS DE BUREAU



COLOR TAPIZADO



/NG /BD /AZ /VD /GR /OC

REF L H

SEP/1/80	40 x 80	4,6
SEP/1/120	40 x 120	4,6
SEP/1/140	40 x 140	4,6
SEP/1/160	40 x 160	4,6
SEP/1/180	40 x 180	4,6
SEP/1/200	40 x 200	4,6

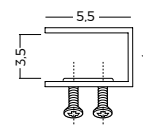
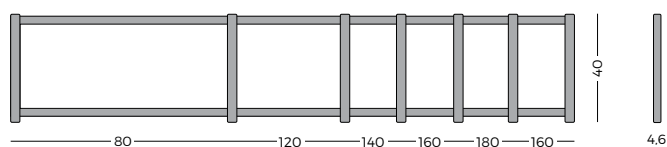

* Sujeción (x2)

SEPARADOR DE ESCRITORIO

ESP Colección de separadores de sobremesa acústicos tapizados con tela disponible en 6 colores. Perfil de aluminio anodizado plata mate. Conjunto fonoabsorbente.

DESKTOP SEPARATOR

ENG Collection of acoustic desktop separators with 6 different colours of fabric. Profile of anodized aluminium matt silver. Sound absorbing assembly.

SÉPARATEURS DE BUREAU

FRA Collection de cloisons et séparateurs acoustiques de bureau, disponible en toile avec 6 couleurs au choix. Profil en aluminium mat anodisé argent mat, avec ensemble amortissant.

ATRIL PARA CONFERENCIAS
CONFERENCE LECTERNS
PUPITRE POUR CONFÉRENCES
ATR

Pie regulable/Adjustable stand

A

B

REF	H	L
A ATR/1	122	51 x 31
B ATR/2	110	40 x 30

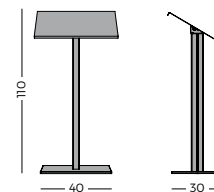
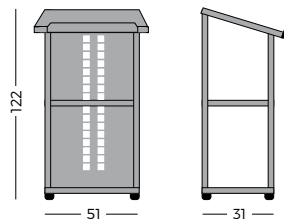
ATRIL

ESP Atriles para conferencias. ATR/1 fabricado con estructura de aluminio anodizado en plata mate y plancha perforada del mismo color. El sobre inclinado, la base y el estante son de madera de haya. La base incluye 4 niveladores regulables en altura. ATR/2 fabricado en chapa de hierro y aluminio anodizado.

LECTERN

ENG Conference lecterns. ATR/1 made from with silver aluminium anodised structure and perforated plate in the same colour. The inclined top, base and shelf are made of beech wood. The base contains 4 height adjustable levelings to level out the ground drops. ATR/2 made from iron sheets and anodized aluminium.

PUPITRE

FRA Pupitres de conférences. ATR/1 fabriqué avec une structure en aluminium anodisée de couleur argent mat. La tablette inclinée ainsi que la base sont en bois d'hêtre. La base à 4 niveleurs réglables en hauteur. Idéal pour les salles de formation et de conventions. ATR/2 structure métallique et aluminium anodisé.



MESAS

MESAS MODULAR
MODULAR TABLES
TABLES MODULAIRES



ACABADOS



MESAS

REF	↓	?	↑
1 MR/...	72	140 x 70	2.5
2 MT/...	72	140 x 60	2.5
3 MC/...	72	70 x 70	2.5

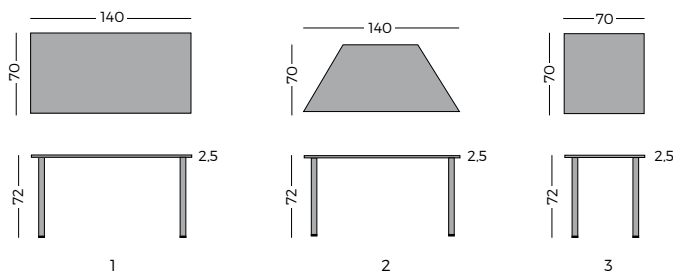

MAMPARA MODULAR

ESP Mesa modular fabricada con tablero melaminado blanco o de haya, de 25 mm de grosor. Canteado con PVC de 3 mm. antichoque. Patas de tubo de aluminio de 5 cm de diámetro y canteado final regulable 5 cm., para corregir posibles desniveles del suelo. Disponibles en 3 formatos.

MODULATED FELT BOARDS

ENG Modular tables made with 25 mm. thick laminated grey wood table top (lined with antishock 3 mm. thick PVC). Aluminium supports are 5 cm. diameter and have a 5 cm. long metal tip to adjust for different floor levels. Available in 3 different formats.

CLOISONS MODULAIRES

FRA Tables modulaires en mélamine de 25 mm. d'épaisseur, grise avec coins de 3 mm. antichoc. Pieds en aluminium de couleur noire, 5 cm de diamètre et support final réglable sur 5 cm pour corriger les possibles dénivelllements du sol. 3 formats différents.



MADERA NATURAL

REF | | ? | |

1	MR/M	72	140 x 70	2.5
2	MT/M	72	140 x 60	2.5
3	MC/M	72	70 x 70	2.5



MELAMINA BLANCA

REF | | ? | |

1	MR/BL	72	140 x 70	2.5
2	MT/BL	72	140 x 60	2.5
3	MC/BL	72	70 x 70	2.5



CON PATAS PLEGABLE

REF | | ? | |

1	MR/M/PP	72	140 x 70	2.5
1	MR/BL/PP	72	140 x 70	2.5

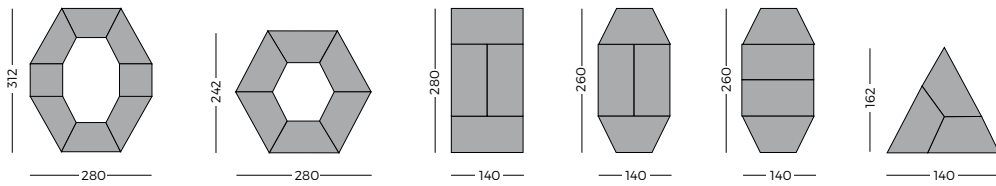

PATAS

REF | | ? | | DESCR.

M/PP	70	ø 5	Pata plegable
MR/PF/PL	70	ø 5	Pata fija



ACABADOS

MADERA HAYA - /M MELAMINA BLANCA - /BL

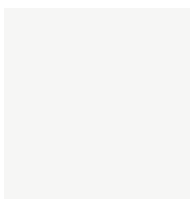



TIME

RELOJ MURAL
WALL CLOCK
HORLOGE MURALE



Batería no incluida/Batery not included

REF	∅	- -
RE/AC/26	26	4
RE/AC/31	31	4
RE/AC/38	38	4

REF	∅	- -
RE/ME/38	38	5.5
RE/ME/60	60	5.5
RE/ME/75	75	5.5

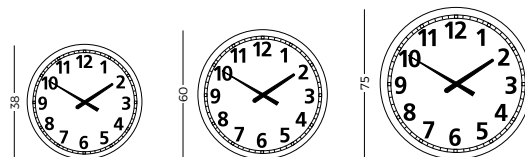

RELOJ MURAL "TIME"

ESP Colección de relojes fabricados en plástico y metal de alta calidad. Disponibles en varios tamaños, colores y diferentes acabados. Ideales para oficinas, colectividades y ambientes comunes.

WALL CLOCK "TIME"

ENG High quality clock range made of metal and plastic. Available in various colours, sizes and finishes. Suitable for offices and public/private places.

HORLOGE MURALE "TIME"

FRA Collection d'horloges en plastique et métal de très bonne qualité. Disponibles en plusieurs couleurs, dimensions et finitions. Idéale pour le bureau, les parties communes et publiques.

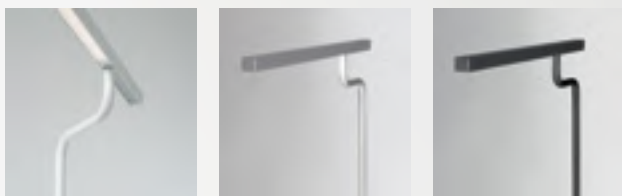

MODULPLAN

LÁMPARA SOBREMESA
TABLE LAMP
LAMPE DE BUREAU

LIGHTS



COLORES



/BL /GR /NG

REF	L	H	Lúmens	Lamp
LAS/108	37 x 50,2	17,5	800 lm	10W LED - 4000K

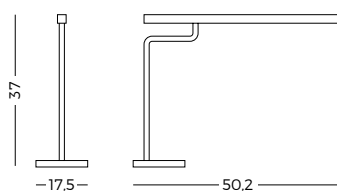

LÁMPARA SOBREMESA

ESP Lámpara de sobremesa de diseño italiano, disponible en 3 colores. Fabricada en aluminio, con una luz LED de 800 lm. El largo cabezal pivota para iluminar una mayor superficie. Capacidad de regular la luz de 0-100% mediante un sensor táctil.

TABLE LAMP

ENG Italian designed table lamp available in 3 colours. Made of aluminium, with an LED light of 800 lm. The long head pivots to illuminate a larger surface. Ability to regulate light from 0-100% using a tactile sensor.

LAMPE DE BUREAU

FRA Lampe de table de design italien, disponible en 3 couleurs. Fabriquée en aluminium, avec LED de 800 lm. La longue tête de lampe pivote afin d'illuminer une plus grande superficie. Réglage de l'intensité de la lumière de 0 à 100% via un capteur tactile.

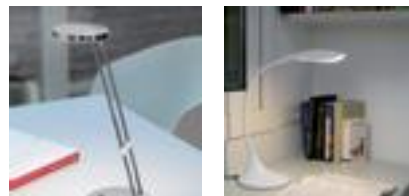

COLOR



REF	L	H	Lúmens	Lamp
LAS/101	15,5-34 x 12,5	10,5	800 lm	10W LED - 4000K

COLORES



REF	L	H	Lúmens	Lamp
LAS/105	16,5-42 x 6,8-17,5	12,5-32	550 lm	6W LED - 4000K

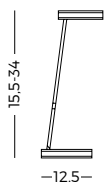

LÁMPARA SOBREMESA

ESP Colección de lámparas de sobremesa de diseño y de alta calidad. Distintas referencias disponibles para diferentes espacios y proyectos. Lámparas LED y bombillas de bajo consumo. Recomendable tanto para oficina y contract como para el hogar.

TABLE LAMP

ENG Collection of high quality designer table lamps. Different models available depending on use. LED lamps with energy saving bulbs. Recommended for office, contract as well as home use.

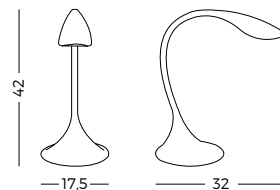

LAMPE DE BUREAU

FRA Collection de lampes de table design de grande qualité. Plusieurs références disponibles pour différents espaces et projets. Lampes LED et ampoule basse consommation. Recommandées tant pour le bureau et le « contract » que pour la maison.



MODULPLAN

LÁMPARA SOBREMESA
TABLE LAMP
LAMPE DE BUREAU

LIGHTS



COLORES



/BL /GR /NG /VD

REF	L	H	Lúmens	Lamp	Colores
A LAS/106	15,7-40 x 13,7-35	5,3-13,5	550 lm	6W LED - 4000K	/BL /NG
B LAS/104	60 x 22	45	640 lm	7W LED - 2700K	/NG
C LAS/107	49 x 16	34	250 lm	11W LED - 2700K	/BL /GR /NG /VD

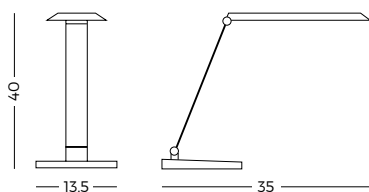

LÁMPARA SOBREMESA

ESP Colección de lámparas de sobremesa de diseño y de alta calidad. Distintas referencias disponibles para diferentes espacios y proyectos. Lámparas LED y bombillas de bajo consumo. Recomendable tanto para oficina y contract como para el hogar.

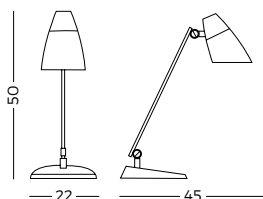
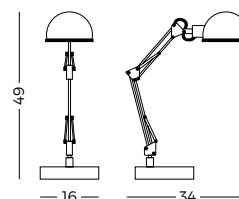

TABLE LAMP

ENG Collection of high quality designer table lamps. Different models available depending on use. LED lamps with energy saving bulbs. Recommended for office, contract as well as home use.



LAMPE DE BUREAU

FRA Collection de lampes de table design de grande qualité. Plusieurs références disponibles pour différents espaces et projets. Lampes LED et ampoule basse consommation. Recommandées tant pour le bureau et le « contract » que pour la maison.

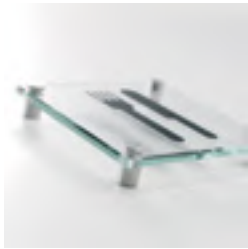

06

ROTULPLAN

SISTEMAS DE ROTULACIÓN
SIGN SYSTEMS
SYSTÈMES DE SIGNALÉTIQUE



COLOR LACADO

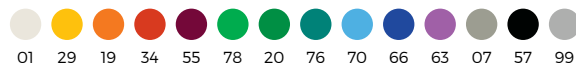

REF Características

788/M Mural
788/P Pictograma

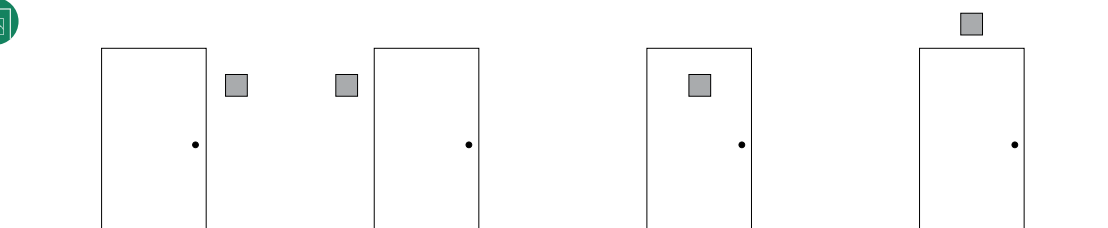

PICTOGRAMAS

ESP Pictograma mural con silueta de vinilo en color blanco o negro, fabricado con perfil de aluminio lacado disponible en 14 colores standard y 4 tamaños distintos 12 x 12, 16 x 16, 12 x 24 y 16 x 32 cm. Las fijaciones laterales son metálicas pintadas en negro.

PICTOGRAM

ENG Aluminium wall pictogram with white or black pictures and 14 different colour backdrops. Available in 4 sizes 12 x 12, 16 x 16, 12 x 24 and 16 x 32 cm. End caps are painted in black. Fixed to the wall through screws and optionally through double face adhesive.

PICTOGRAMME

FRA Pictogramme mural sur profil en aluminium laqué avec marquage en vinyle blanc ou noir. Disponible en 4 formats 12 x 12, 16 x 16, 12 x 24 et 16 x 32 cm. et plaques en 14 couleurs standard. Les fixations latérales sont métalliques coloris noir. Option adhesif.



Kit de adhesivos de doble cara
Doubled sided adhesive kit
Kit d'autocollants double face

MURAL

REF L H

788/M/12	12 x 12	0,9
788/M/16	16 x 16	0,9
788/M/24	12 x 24	0,9
788/M/32	16 x 32	0,9



ADHESIVO

REF L

AD/12	2 x 12
AD/16	2 x 16



PROYECTADO

REF L H

788/P/12	12 x 12	0,9
788/P/16	16 x 16	0,9
788/P/24	12 x 24	0,9
788/P/32	16 x 32	0,9

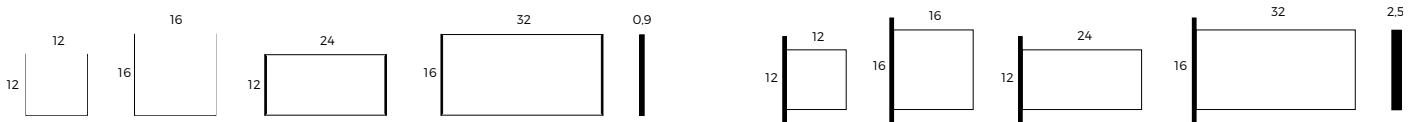

PICTOGRAMAS



- | | | | | |
|----------------------------------|---|------------------------------------|--|-------------------------------------|
| 1. Aseos caballeros / Men toilet | 10. No fumar / No smoking | 21. Salida / Way out | 41. Peluquería / Hairdresser | 51. Pto. de encuentro / Mtg. point |
| 2. Aseos señora / Women toilet | 11. Flecha / Arrow | 22. Entrada / Way in | 42. Oficina / Office | 52. Biblioteca / Library |
| 3. Aseos / Toilets/restroom | 13. Ascensor / Lift | 24. Limpieza / Cleaning room | 44. Consigna / Lockers | 54. Escaleras mecánicas / Escalator |
| 4. Restaurante / Restaurant | 14. Diversidad funcional / Functional diversity | 25. Correos / Post office | 45. Recepción / Reception | 60. Fumadores / Smocking room |
| 5. Cafetería / Coffee shop | 15. Sala de reuniones / Mtg. room | 36. Ducha / Shower | 47. Sala TV / TV room | 61. Animales no / No animals entry |
| 6. Teléfono / Téléphone | 16. Subida escaleras / Up stairs | 37. Piscina / Swimming pool | 48. Servicios médicos / Medical facilities | 64. Enfermería / Infirmary |
| 7. Información / Information | 18. Bajada escaleras / Down stairs | 39. Vest. masc. / Men change room | 49. Hospital / Hospital | 69. Basuras no / Rubbish bin |
| 8. Guardarropa / Cloakroom | 20. Sala espera / Waiting room | 40. Vest. fem. / Women change room | 50. Silencio / Silence | 74. Fotos no / No cameras |
| 9. No pasar / Do not cross | | | | 164. Móviles no / No mobile phones |

ROTULPLAN



789/M

RÓTULOS MURALES
WALL SIGNS
SIGNALÉTIQUE MURALE

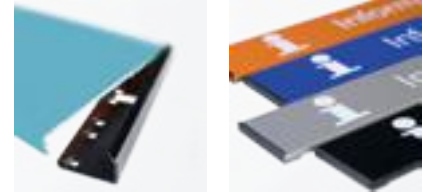

COLOR LACADO

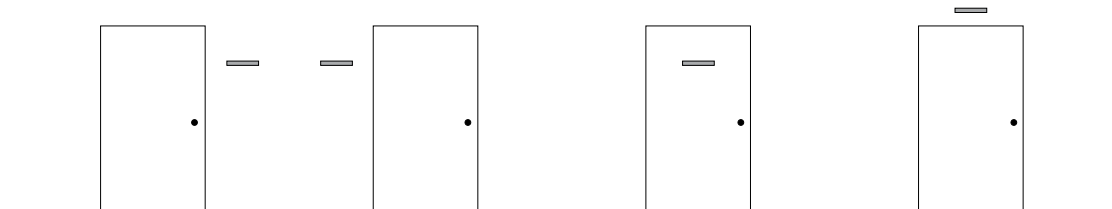
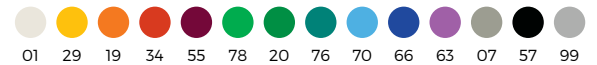

RÓTULOS MURALES MARGEN PUERTA

ESP Rótulo mural margen puerta de aluminio lacado, de texto fijo en vinilo de color blanco o negro. Disponible en 5 medidas de altura, 4, 8, 12 y 16 cm. y 14 colores standard. Se aplican sobre la pared mediante tornillos u opcionalmente con adhesivo doble cara.

WALL SIGNS (DOOR FRAMES)

ENG Aluminium wall signs for door frames with white or black letters and 14 different coloured backdrops. Available in 5 distinct sizes with heights of 4, 8, 12 and 16 cm. respectively. Mount any wall sign with screws or adhesives.

SIGNALÉTIQUE MURALE

FRA Signalétique murale sur profil en aluminium laqué avec marquage en vinyle blanc ou noir. Disponible en 5 formats 4, 8, 12, et 16 cm. de haut et 14 coloris standard. Fixation par vis sous la plaque ou optionnellement par adhésif double face.

RÓTULOS				RÓTULOS				RÓTULOS			
REF	L	text	ABC...	REF	L	text	ABC...	REF	L	text	ABC...
789/4/12/M	4 x 12	2	8/10	789/6/24/M	6 x 24	2.6	8/10	789/12/32/M	12 x 32	4.8	8/10
789/4/24/M	4 x 24	2	12/14	789/6/32/M	6 x 32	2.6	12/14	789/12/48/M	12 x 48	4.8	12/14
789/4/32/M	4 x 32	2	18/20	789/6/48/M	6 x 48	2.6	18/20	789/12/64/M	12 x 64	4.8	18/20
789/4/48/M	4 x 48	2	24/26	789/6/64/M	6 x 64	2.6	24/26	789/12/96/M	12 x 96	4.8	24/26
789/4/64/M	4 x 64	2	28/30								
				789/8/24/M	8 x 24	3.2	8/10	789/16/32/M	16 x 32	6.4	6/8
				789/8/32/M	8 x 32	3.2	12/14	789/16/48/M	16 x 48	6.4	8/10
				789/8/48/M	8 x 48	3.2	18/20	789/16/64/M	16 x 64	6.4	12/14
				789/8/64/M	8 x 64	3.2	24/26	789/16/96/M	16 x 96	6.4	18/20

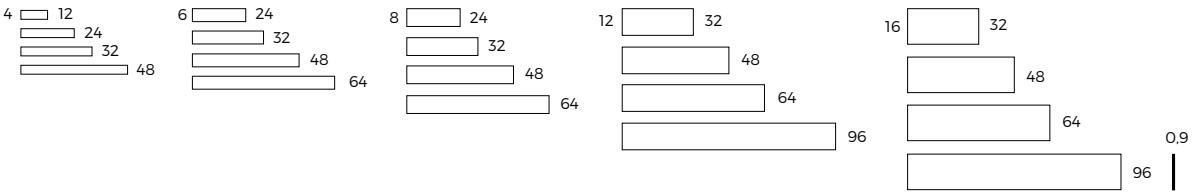

SUBRAYADO

REF	L	text
LS/1/12/M	1 x 12	0.9
LS/1/24/M	1 x 24	0.9
LS/1/32/M	1 x 32	0.9
LS/1/48/M	1 x 48	0.9
LS/1/64/M	1 x 64	0.9
LS/1/96/M	1 x 96	0.9

SUBRAYADO

REF	L	text
LS/2/12/M	2 x 12	0.9
LS/2/24/M	2 x 24	0.9
LS/2/32/M	2 x 32	0.9
LS/2/48/M	2 x 48	0.9
LS/2/64/M	2 x 64	0.9
LS/2/96/M	2 x 96	0.9

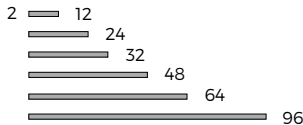
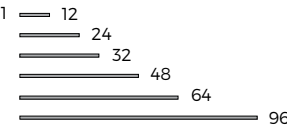

* TA/24 — Planta 2 →



TEXTOS

REF	L
TA/24	24
TA/32	32
TA/48	48
TA/64	64
TA/96	96

SOBREMESA

REF	L	text
789/4/24/SB	4 x 24	0.9
789/4/32/SB	4 x 32	0.9
789/8/24/SB	8 x 24	0.9
789/8/32/SB	8 x 32	0.9

ADHESIVO

REF	L
AD/4	4 x 2
AD/8	8 x 2
AD/12	12 x 2
AD/16	16 x 2



789/P

RÓTULO PROYECTADO
 FLAG SIGNS
 SIGNALÉTIQUE EN DRAPEAU



COLOR LACADO

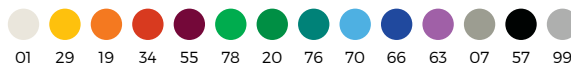

RÓTULO

REF	L	H
789/8/24/P	8 x 24	2.5
789/8/32/P	8 x 32	2.5
789/8/48/P	8 x 48	2.5
789/12/24/P	12 x 24	2.5
789/12/32/P	12 x 32	2.5
789/12/48/P	12 x 48	2.5
789/16/24/P	16 x 24	2.5
789/16/32/P	16 x 32	2.5
789/16/48/P	16 x 48	2.5



SUBRAYADO

REF	L	H
LS/1/24/P	1 x 24	2.5
LS/1/32/P	1 x 32	2.5
LS/1/48/P	1 x 48	2.5
LS/2/24/P	2 x 24	2.5
LS/2/32/P	2 x 32	2.5
LS/2/48/P	2 x 48	2.5

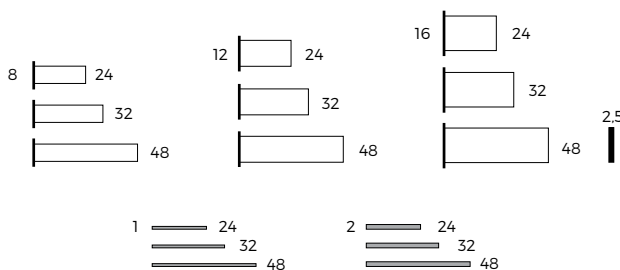

RÓTULO PROYECTADO

ESP Rótulo proyectado doble cara de aluminio lacado, de texto fijo en vinilo de color blanco o negro. Disponible en 3 medidas de altura, 8, 12 y 16 cm. y de longitud 24, 32 y 48 cm. Se aplican sobre la pared mediante tornillos.

FLAG SIGNS

ENG Aluminium double sided flag wall signs with white or black letters. Available in 3 distinct sizes with heights of 8, 12 and 16 cm. and lengths of 24, 32 and 48 cm. respectively. Mount any projected wall sign with screws.

SIGNALÉTIQUE EN DRAPEAU

FRA Signalétique en drapeau sur profil en aluminium laqué avec marquage en vinyle blanc ou noir. Disponible en 3 formats 8, 12 et 16 cm. de haut. et 24, 32 et 48 cm. de longueurs. Fixation par vis sur la plaque.



ROTUPLAN

RÓTULO **SUSPENDIDO**
SUSPENDED SIGNS
 SIGNALÉTIQUE **SUSPENDUE**

789/s



COLOR LACADO

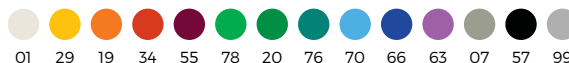

RÓTULO

REF	L	H
789/8/48/S	8 x 48	2.5
789/8/64/S	8 x 64	2.5
789/8/96/S	8 x 96	2.5
789/12/48/S	12 x 48	2.5
789/12/64/S	12 x 64	2.5
789/12/96/S	12 x 96	2.5
789/16/48/S	16 x 48	2.5
789/16/64/S	16 x 64	2.5
789/16/96/S	16 x 96	2.5

SUBRAYADO

REF	L	H
LS/1/48/S	1 x 48	2.5
LS/1/64/S	1 x 64	2.5
LS/1/96/S	1 x 96	2.5
LS/2/48/S	2 x 48	2.5
LS/2/64/S	2 x 64	2.5
LS/2/96/S	2 x 96	2.5

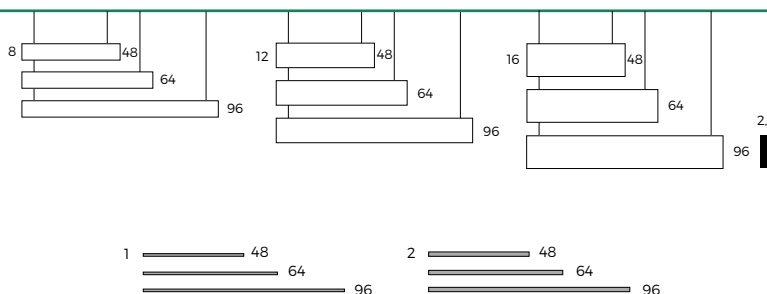

RÓTULO SUSPENDIDO

ESP Rótulo suspendido doble cara de aluminio lacado, de texto fijo en vinilo de color blanco o negro. Disponible en 3 medidas de altura, 8, 12 y 16 cm. Se suspenden del techo mediante cable de metal (incluido). Estas señales se colocan en pasillos y accesos.

SUSPENDED SIGNS

ENG Aluminium suspended signs with white or black letters and 14 different colored backdrops. Available in 3 distinct sizes with heights of 8, 12 and 16 cm. Suspend sign with included metallic string.

SIGNALÉTIQUE SUSPENDU

FRA Signalétique suspendue sur profil en aluminium laqué avec marquage en vinyle blanc ou noir. Disponible en 3 formats 8, 12, et 16 cm. de hauteur. Suspendus au plafond par un câble de métallique (inclus).



790/D^W



COLOR LACADO

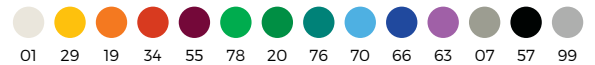

2	Marketing Administration
1	R+D Laboratory
0	Reception

GANT HOTEL	
1. Information	→
2. Rooms	↑
3. Pool	←
4. Gymnasium	↓
1	2
3	4

High School	
Classroom 1-10	→
Classroom 11-20	→
Classroom 21-30	↑
Classroom 31-40	↑
Information	→
Gymnasium	←
Toilets	↑

SPORT	
Gymnasium	→
Cafeteria	→
Natatorium	↑
Toilets	↑
Fitness Center	→
Tennis Courts	←

3	UCI Administration
2	Oncology Endoscopy
1	Medical Imaging Volunter Service
0	Main Entrane Administration Waiting Room

DIRECTORIOS MURALES

ESP Directorio formado por lamas de aluminio lacado, de texto fijo en vinilo de color blanco o negro. Disponible en 7 medidas de altura, 1, 2, 4, 6, 8, 12 y 16 cm. Disponible en 14 colores.

DIRECTIONAL SIGNS

ENG Lacquered aluminium mini directories with white or black letters and 14 different colour backdrops. Available in 7 distinct sizes with heights of 1, 2, 4, 6, 8, 12 and 16 cm.

MULTI-PLAQUES

FRA Directoire multi plaques sur profil en aluminium laqué avec lettres blanches ou noires et 14 coloris standard. Disponible en 7 formats 1, 2, 4, 6, 8, 12 et 16 cm. de haut.

PLANTA 2

Información

RÓTULOS PARA DIRECTORIO

REF	L	text	ABC...
790/1/24/D	1 x 24	-	-
790/1/32/D	1 x 32	-	-
790/1/48/D	1 x 48	-	-
790/1/64/D	1 x 64	-	-
790/1/96/D	1 x 96	-	-
790/2/24/D	2 x 24	-	-
790/2/32/D	2 x 32	-	-
790/2/48/D	2 x 48	-	-
790/2/64/D	2 x 64	-	-
790/2/96/D	2 x 96	-	-
790/4/24/D	4 x 24	2	12/20
790/4/32/D	4 x 32	2	18/24
790/4/48/D	4 x 48	2	24/26
790/4/64/D	4 x 64	2	36/38
790/4/96/D	4 x 96	2	60/62

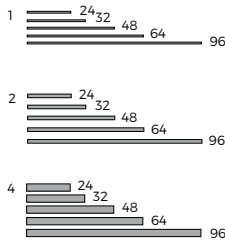

RÓTULOS PARA DIRECTORIO

REF	L	text	ABC...
790/6/24/D	6 x 24	2	10/18
790/6/32/D	6 x 32	2	14/16
790/6/48/D	6 x 48	2	20/24
790/6/64/D	6 x 64	2	30/36
790/6/96/D	6 x 96	2	40/48
790/8/24/D	8 x 24	3,2	8/10
790/8/32/D	8 x 32	3,2	12/14
790/8/48/D	8 x 48	3,2	16/18
790/8/64/D	8 x 64	3,2	24/26
790/8/96/D	8 x 96	3,2	36/38

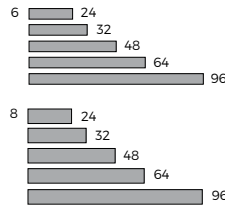

RÓTULOS PARA DIRECTORIO

REF	L	text	ABC...
790/12/24/D	12 x 24	4,8	6/8
790/12/32/D	12 x 32	4,8	8/10
790/12/48/D	12 x 48	4,8	12/14
790/12/64/D	12 x 64	4,8	18/20
790/12/96/D	12 x 96	4,8	24/26
790/16/24/D	16 x 24	6,4	4/6
790/16/32/D	16 x 32	6,4	6/8
790/16/48/D	16 x 48	6,4	8/10
790/16/64/D	16 x 64	6,4	12/24
790/16/96/D	16 x 96	6,4	18/20

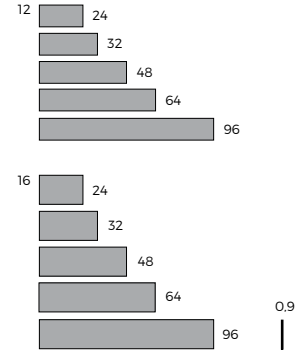

* TA/24 Información Planta 2

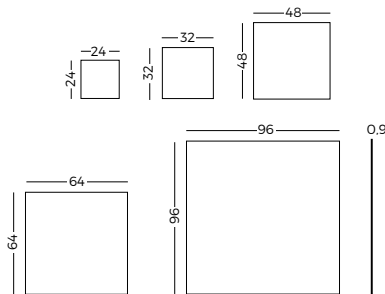

TEXTOS

REF	L
TA/24	24
TA/32	32
TA/48	48
TA/64	64
TA/96	96

PLANOS

REF	L	
790/PD/24	24 x 24	0,9
790/PD/32	32 x 32	0,9
790/PD/48	48 x 48	0,9
790/PD/64	64 x 64	0,9
790/PD/96	96 x 96	0,9

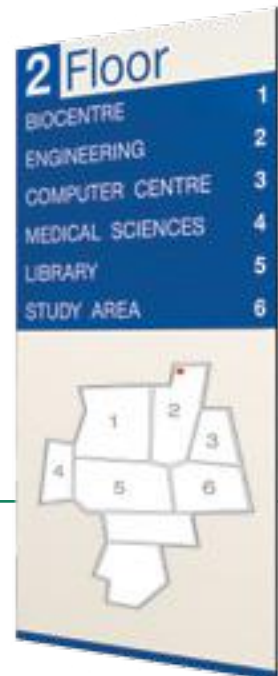



789/T

RÓTULO PARA EXTERIOR
OUTDOOR SIGNS
SIGNALÉTIQUE EXTERIEURE

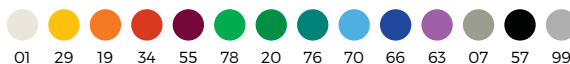

POSTES

REF	↑	⇄
790/T/120	120	7 x 7
790/T/180	180	7 x 7
790/T/240	240	7 x 7

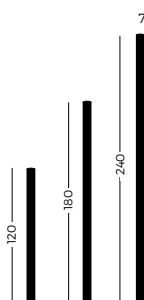

LAMAS

REF	⊥	⇄
790/12/96/T	12 x 96	2.5
790/12/144/T	12 x 144	2.5
790/16/96/T	16 x 96	2.5
790/16/144/T	16 x 144	2.5

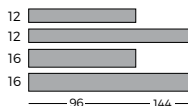

RÓTULO

REF	⊥	⇄
790/PD/96/T	96 x 96	2.5
790/PD/144/T	96 x 144	2.5

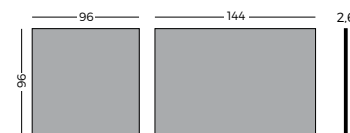

RÓTULO PARA EXTERIOR

ESP Rótulo instalado en la parte exterior de los edificios para la orientación, señalización y situación de diferentes lugares exteriores como zonas de entrada, almacenes, p rkings, parques tem ticos, etc. y para ubicaci n de lugares en el interior del edificio.

OUTDOOR SIGNS

ENG Signs placed in the outer part of the buildings for the direction, signalling and situation of different outer places like zones from entrance, warehouses, p rkings, thematic parks, etc. and for location of places in the interior of the buildings. Post, bar and panel system.

SIGNAL TIQUE EXTERIEURE

FRA Directoire multi plaques sur profil en aluminium laqu  avec lettres blanches ou noires et 14 coloris standard. Disponible en 6 formats 1, 2, 4, 8, 12 et 16 cm. de haut. Placez les multi plaques sur potaux pour exterieur comme parking, all e, etc...



ROTUPLAN

RÓTULOS DE ALUMINIO
ALUMINIUM SIGN
SIGNALÉTIQUE EN ALUMINIUM

BL/RO

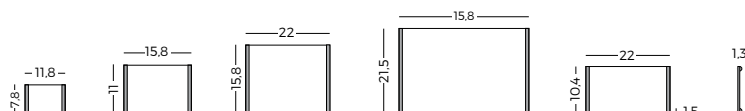

REF	L	L ₁	H
BL/RO/0001	7,4 x 10,5	7,8 x 11,8	1,3
BL/RO/0002	10,5 x 14,8	11 x 15,8	1,3
BL/RO/0003	14,8 x 21	15,3 x 22	1,3
BL/RO/0004	21 x 29,7	21,5 x 30,7	1,3
BL/RO/0005	9,9 x 21	10,4 x 22	1,3



RÓTULOS DE ALUMINIO "SNAP"

ESP Rótulo suspendido doble cara de aluminio lacado, de texto fijo en vinilo de color blanco o negro. Disponible en 3 medidas de altura, 8, 12 y 16 cm. Se suspenden del techo mediante cable de nylon (incluido). Estas señales se colocan en pasillos y accesos.

"SNAP" ALUMINIUM SIGN

ENG Aluminium suspended signs with white or black letters and 14 different colored backdrops. Available in 3 distinct sizes with heights of 8, 12 and 16 cm. Suspend sign with included nylon string.

SIGNALÉTIQUE EN ALUMINIUM "SNAP"

FRA Signalétique suspendu sur profil en aluminium laqué avec marquage en vinyle blanc ou noir. Disponible en 3 formats 8, 12, et 16 cm. de hauteur. Suspendus au plafond par un câble de nylon (inclus).



793/M

RÓTULO CURVO
CURVED SIGNS
SIGNALÉTIQUE EN COURBÉ



*Los rótulos se suministran sin papel / Signs supplied without paper

REF	L	H	?	REF	L	H	?
793/M/12	12 x 12	1	11,5 x 12	793/M/50	50 x 50	2,5	49,5 x 50
793/M/15	15 x 15	1,2	14,5 x 15	793/M/60	60 x 60	3	59,5 x 60
793/M/21	21 x 21	1,4	20,5 x 21	793/M/A5	21 x 15	1,2	20,5 x 15
793/M/30	30 x 30	1,8	29,5 x 30	793/M/A4	29,7 x 21	1,4	29,2 x 21
793/M/40	40 x 40	2	39,5 x 40	793/M/A3	42 x 29,7	1,8	41,5 x 29,7

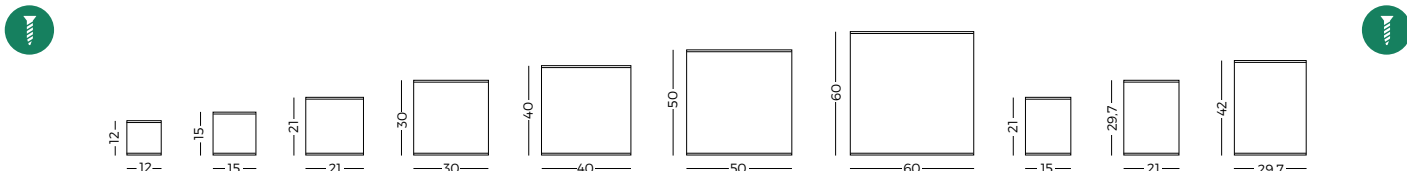

PICTOGRAMA Y DIRECTORIO PERFIL CURVO

ESP Rótulos de perfil curvo para pictogramas murales. Está fabricado con perfil de aluminio anodinado en color plata mate. El soporte permite la incorporación del papel pictograma o texto). Mediante una ventosa especial se puede levantar el plástico protector.

CURVED PICTOGRAMS AND DIRECTORIES

ENG Curved profile wall pictos made with silver anodised aluminium frame. The transparent sleeve allows you to add paper with pictograms or text. With suction cup pull off transparent sleeve to change text. Place on the wall with screws or optionally adhesive.

PICTOGRAMMES ET MULTI-PLAQUES COURBÉ

FRA Profil mural en aluminium anodisé convexe pour signalétique ou pictogrammes. L'incorporation de l'information papier (picto ou texte) est facile. Grâce à une ventouse on enlève le plastique transparent qui protège le support et on insère le texte.



ROTUPLAN

PICTOGRAMA PROYECTADO **CURVO**
CURVED DOUBLE SIDED FLAG PICTOGRAM
 PICTOGRAMME EN DRAPEAU **COURBÉ**

793/P



REF	L	H	?
793/P/15	15 x 15	2,4	14,5 x 15
793/P/21	21 x 21	2,8	20,5 x 21
793/P/30	30 x 30	3,6	29,5 x 30

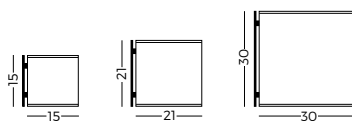

PICTOGRAMA PROYECTADO CURVO

ESP Rótulo de perfil curvo para pictogramas proyectados (doble cara). Está fabricado con perfil de aluminio anodizado en color plata mate. El soporte permite la incorporación del papel (pictograma o texto). Mediante una ventosa se puede levantar el plástico protector.

CURVED DOUBLE SIDED FLAG PICTOGRAM

ENG Curved profile double sided flag pictos with for wall pictograms made with silver anodised aluminium frame. The support allows you to add paper with pictograms or text. With suction cup pull off transparent sleeve. Place on the wall with screws.

PICTOGRAMME EN DRAPEAU COURBÉ

FRA Profil mural en aluminium anodisé convexe pour signalétique ou pictogrammes. L'incorporation de l'information papier (picto ou texte) est facile. Grâce à une ventouse on enlève le plastique transparent qui protège le support et on insère le texte.



799/M

RÓTULO MURAL CURVO
CURVED PROFILE SIGN
SIGNALÉTIQUE COURBE



*Los rótulos se suministran sin papel/ Signs supplied without paper

REF Características

- 799/M Mural
- 799/P Pictograma

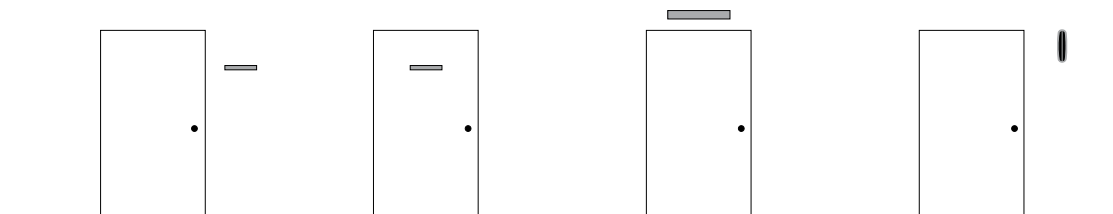

RÓTULO MURAL PERFIL CURVO

ESP Rótulo mural de perfil curvo. Está fabricado con perfil de aluminio anodizado en color plata mate. El soporte permite la incorporación del papel (pictograma o texto). Mediante una ventosa especial se puede levantar frontalmente el plástico transparente que lo protege.

CURVED PROFILE SIGN

ENG Wall curved profile sign made with silver anodised aluminium frame. The transparent sleeve allows you to add paper with pictograms or text. With a suction cup pull off the transparent sleeve to change the text. Placed on the wall with screws or with adhesive.

SIGNALÉTIQUE PROFIL COURBE

FRA Profil mural en aluminium anodisé convexe pour signalétique ou pictogrammes. L'incorporation de l'information papier (picto ou texte) est facile. Grâce à une ventouse on enlève le plastique transparent qui protège le support et on insère le texte. Option adhesifs.



MURAL

REF L H

799/4/12/M	4 x 12	0.8
799/4/24/M	4 x 24	0.8
799/4/32/M	4 x 32	0.8
799/4/48/M	4 x 48	0.8
799/4/64/M	4 x 64	0.8
799/6/12/M	6 x 12	0.8
799/6/24/M	6 x 24	0.8
799/6/32/M	6 x 32	0.8
799/6/48/M	6 x 48	0.8
799/6/64/M	6 x 64	0.8
799/8/12/M	8 x 12	1
799/8/24/M	8 x 24	1
799/8/32/M	8 x 32	1
799/8/48/M	8 x 48	1
799/8/64/M	8 x 64	1
799/12/24/M	12 x 24	1
799/12/32/M	12 x 32	1
799/12/48/M	12 x 48	1
799/12/64/M	12 x 64	1
799/12/72/M	12 x 72	1
799/15/24/M	15 x 24	1.2
799/15/32/M	15 x 32	1.2
799/15/48/M	15 x 48	1.2
799/15/64/M	15 x 64	1.2
799/15/72/M	15 x 72	1.2

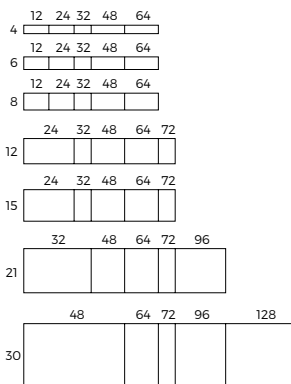

PROYECTADO

REF L H

799/15/24/P	15 x 24	2.4
799/15/32/P	15 x 32	2.4
799/15/48/P	15 x 48	2.4
799/30/32/P	30 x 32	3.6
799/30/48/P	30 x 48	3.6

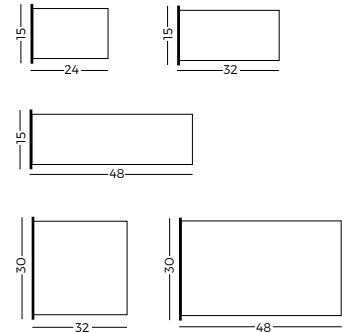

REF L H

799/21/32/M	21 x 32	1.4
799/21/48/M	21 x 48	1.4
799/21/64/M	21 x 64	1.4
799/21/72/M	21 x 72	1.4
799/21/96/M	21 x 96	1.4
799/30/48/M	30 x 48	1.8
799/30/64/M	30 x 64	1.8
799/30/72/M	30 x 72	1.8
799/30/96/M	30 x 96	1.8
799/30/128/M	30 x 128	1.8
799/40/64/M	40 x 64	2
799/40/72/M	40 x 72	2
799/40/96/M	40 x 96	2
799/40/128/M	40 x 128	2
799/50/64/M	50 x 64	2
799/50/72/M	50 x 72	2
799/50/96/M	50 x 96	2
799/50/128/M	50 x 128	2
799/60/72/M	60 x 72	2
799/60/96/M	60 x 96	2
799/60/128/M	60 x 128	2
799/60/144/M	60 x 144	2

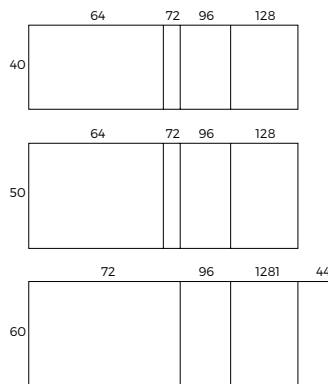



799/S

RÓTULO **SUSPENDIDO CURVO**
SUSPENDED CURVED SIGNS
 SIGNALÉTIQUE **SUSPENDUË COURBÉ**

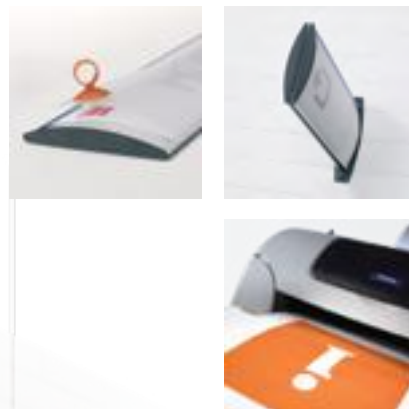

*Los rótulos se suministran sin papel/ Signs supplied without paper

REF	L	H
799/8/48/S	8 x 48	2
799/8/64/S	8 x 64	2
799/8/96/S	8 x 96	2
799/12/48/S	12 x 48	2
799/12/64/S	12 x 64	2
799/12/96/S	12 x 96	2
799/15/48/S	15 x 48	2,4
799/15/64/S	15 x 64	2,4
799/15/96/S	15 x 96	2,4

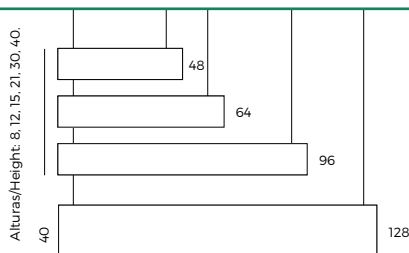

REF	L	H
799/21/48/S	21 x 48	2,8
799/21/64/S	21 x 64	2,8
799/21/96/S	21 x 96	2,8
799/30/48/S	30 x 48	3,6
799/30/64/S	30 x 64	3,6
799/30/96/S	30 x 96	3,6
799/40/64/S	40 x 64	4
799/40/96/S	40 x 96	4
799/40/128/S	40 x 128	4



PICTOGRAMA Y DIRECTORIO PERFIL CURVO

ESP Rótulo suspendido doble cara de perfil curvo. Está fabricado con perfil de aluminio anodizado en color plata mate. El soporte permite la incorporación del papel (pictograma o texto). Mediante una ventosa especial se puede levantar el plástico protector.

SUSPENDED CURVED PROFILE SIGNS

ENG Wall curved profile double side signs made with silver anodised aluminium frame. The transparent sleeve allows you to add paper with pictograms or text. With a suction cup pull off the transparent sleeve to change the text.

SIGNALÉTIQUE SUSPENDU PROFIL COURBÉ

FRA Profil suspendu double face en aluminium anodisé convexe pour signalétique ou pictogrammes. L'incorporation de l'information papier (picto ou texte) est facile. Grâce à une ventouse on enlève le plastique transparent qui protège le support et on insère le texte.





REF	L	H
799/6/24/SB	6 x 24	0.8
799/6/32/SB	6 x 32	0.8
799/8/24/SB	8 x 24	1
799/8/32/SB	8 x 32	1
799/12/12/SB	12 x 12	1

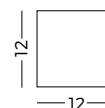
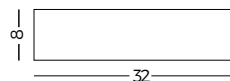
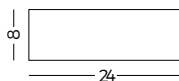
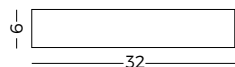
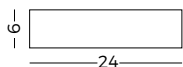

RÓTULO SOBREMESA PERFIL CURVO

ESP Rótulo de sobremesa perfil curvo. Está fabricado con perfil de aluminio anodizado en color plata mate. El soporte permite la incorporación del papel (pictograma o texto) Mediante una ventosa especial se puede levantar el plástico protector.

DESK CURVED PROFILE SIGNS

ENG Signs with curved profile desks wall are made with silver anodised aluminium frame. The transparent sleeve allows you to add paper with pictograms or text. With a suction cup pull off the transparent sleeve to change the text.

SIGNALÉTIQUE À POSER PROFIL COURBÉ

FRA Signalétique à poser, en aluminium anodisé convexe pour signalétique ou pictogrammes. L'incorporation de l'information papier (picto ou texte) est facile. Grâce à une ventouse on enlève le plastique transparent qui protège le support et on insère le texte.



799/M

DIRECTORIOS PERFIL CURVO
CURVED PROFILE DIRECTORIES
MULTI-PLAQUES PROFIL COURBÉ



*Los rótulos se suministran sin papel/ Signs supplied without paper

REF	L	H
799/4/12/M	4 x 12	0.8
799/4/24/M	4 x 24	0.8
799/4/32/M	4 x 32	0.8
799/4/48/M	4 x 48	0.8
799/4/64/M	4 x 64	0.8

799/6/12/M	6 x 12	0.8
799/6/24/M	6 x 24	0.8
799/6/32/M	6 x 32	0.8
799/6/48/M	6 x 48	0.8
799/6/64/M	6 x 64	0.8

12	24	32	48	64
4				
12	24	32	48	64
6				
12	24	32	48	64
8				

REF	L	H
799/8/12/M	8 x 12	1
799/8/24/M	8 x 24	1
799/8/32/M	8 x 32	1
799/8/48/M	8 x 48	1
799/8/64/M	8 x 64	1
799/8/96/M	8 x 96	1

24	32	48	64	72
12				
24	32	48	64	72
15				

REF	L	H
799/12/24/M	12 x 24	1
799/12/32/M	12 x 32	1
799/12/48/M	12 x 48	1
799/12/64/M	12 x 64	1
799/12/72/M	12 x 72	1

799/15/24/M	15 x 24	1.2
799/15/32/M	15 x 32	1.2
799/15/48/M	15 x 48	1.2
799/15/64/M	15 x 64	1.2
799/15/72/M	15 x 72	1.2



DIRECTORIOS PERFIL CURVO

ESP Rótulo mural de perfil curvo. Está fabricado con perfil de aluminio anodizado en color plata mate. El soporte permite la incorporación del papel (pictograma o texto). Mediante una ventosa especial se puede levantar frontalmente el plástico transparente que lo protege.

CURVED PROFILE DIRECTORIES

ENG Wall curved profile sign made with silver anodised aluminium frame. The transparent sleeve allows you to add paper with pictograms or text. With a suction cup pull off the transparent sleeve to change the text. Placed on the wall with screws or with adhesive.

MULTI-PLAQUES PROFIL COURBÉ

FRA Profil mural en aluminium anodisé convexe pour signalétique ou pictogrammes. L'incorporation de l'information papier (picto ou texte) est facile. Grâce à une ventouse on enlève le plastique transparent qui protège le support et on insère le texte.



ATRIL CON PERFIL CURVO
LECTERN WITH CURVED SIGN
CHEVALET AVEC SIGNALÉTIQUE COURBÉ

794/AT



*Los rótulos se suministran sin papel/ Signs supplied without paper

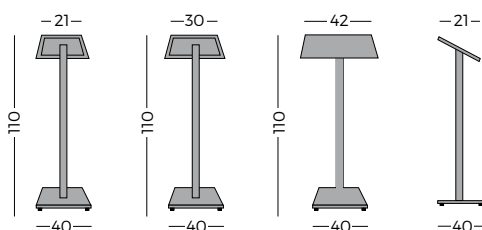

REF	H	L
794/21/AT	110	21 x 21
794/A4/AT	110	21 x 30
794/A3/AT	110	30 x 42



DIRECTORIOS PERFIL CURVO

ESP Atril de aluminio y base metálica con rótulo curvo de aluminio provisto de plástico protector antireflex. Disponible en medidas 21 x 21 cm., Din A4 y Din A3.

CURVED PROFILE DIRECTORIES

ENG Lectern in aluminium and metallic base with aluminium curved sign with a plastic protection antireflex/UV-stabilized. Dimensions 21 x 21 cm, A4 or A3.

MULTI-PLAQUES PROFIL COURBÉ

FRA Chevalet en aluminium et base métallique avec signalétique courbe en aluminium pourvu d'un plastique protecteur anti reflets/anti UV. Dimensions 21 x 21 cm, A4 ou A3.



794/MT

MINI TOTEMS PERFIL CURVO
MINI TOTEM IN CURVED ALUMINIUM
MINI TOTEM EN ALUMINIUM COURBÉ



*Los rótulos se suministran sin papel/ Signs supplied without paper

REF	L	H
794/15/MT1	125 x 15	4,7
794/15/MT2	150 x 15	4,7
794/15/MT3	180 x 15	4,7

REF	L	H
794/21/MT1	125 x 21	4,7
794/21/MT2	150 x 21	4,7
794/21/MT3	180 x 21	4,7

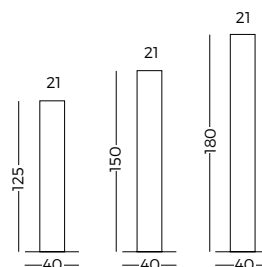
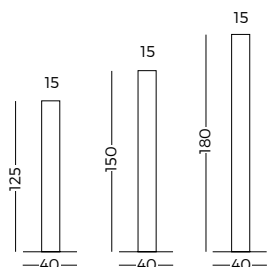

MINI TOTEMS PERFIL CURVO

ESP Mini Totem de aluminio fabricados con perfil curvo provistos de base metálica para ubicar en áreas de interior, de medidas 15 y 21 cm. Permiten personalizarse con una impresión que se ubica debajo del plástico protector transparente antireflex.

MINI TOTEM IN CURVED ALUMINIUM

ENG Mini Totem in curved aluminium for the inside. The support allows to insert a sheet of paper after having removed the plastic protection (UV stabilized/antireflex) thanks to a suction pad.

MINI TOTEM EN ALUMINIUM COURBÉ

FRA Mini Totem en aluminium courbé, pour l'intérieur. Le support permet d'insérer une feuille de papier (pictogramme ou texte) après avoir enlevé la protection en plastique (anti UV/anti reflets) grâce à une ventouse.



ROTUPLAN

TOTEMS PERFIL CURVO
CURVED PROFILE TOTEM
TOTEM PROFIL COURBÉ

799/T



*Los rótulos se suministran sin papel/ Signs supplied without paper

REF	↑	→
799/T2/180	180	80
799/T2/200	200	80

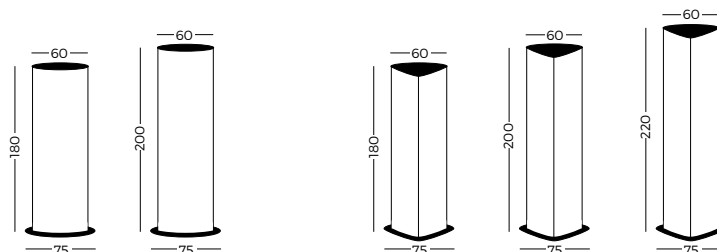

REF	↑	→
799/T2/180	180	60
799/T2/200	200	60
799/T2/220	220	60



DIRECTORIOS PERFIL CURVO

ESP Atril de aluminio y base metálica con rótulo curvo de aluminio provisto de plástico protector antireflex. Disponible en medidas 21 x 21 cm., Din A4 y Din A3.

CURVED PROFILE DIRECTORIES

ENG Lectern in aluminium and metallic base with aluminium curved sign with a plastic protection antireflex/UV-stabilized. Dimensions 21 x 21 cm, A4 or A3.

MULTI-PLAQUES PROFIL COURBÉ

FRA Chevalet en aluminium et base métallique avec signalétique courbé en aluminium pourvu d'un plastique protecteur anti reflets/anti UV. Dimensions 21 x 21 cm, A4 ou A3.



796/M

PICTOGRAMA DE VIDRIO
 GLASS PICTO
 PICTO EN VERRE



COLOR VINILO



RÓTULO

REF Características

796/M Pictograma
 796/P Directorio



ADHESIVO

REF L

796/KAR ø 1

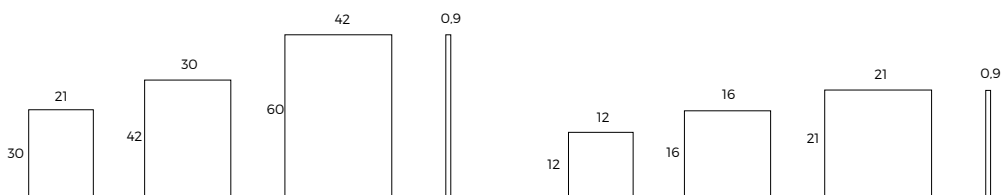

PICTOGRAMA DE VIDRIO

ESP Pictograma fabricado en vidrio templado transparente rotulado mediante vinilo negro. La gama 796 se fija a la pared atornillando los separadores de acero inoxidable (opcionalmente con kit 796/KAR adhesivos).

GLASS PICTO

ENG Pictos made of tempered glass and tracing paper silhouette through thermograving. The range 796 is fixed to the wall through stainless steel screws (optionally with kit 796/KAR adhesives).

PICTO EN VERRE

FRA Gammes de pictogrammes en verre. Silhouette ou texte en vinyle noire. Formats pour tous les usages: signalétique directionnelle, accueil, etc. La gamme 796 est livrée avec la visserie, fixation rapide avec entretoises en acier inox. Option adhesifs.



PICTOGRAMAS

REF L H

796/M/12	12 x 12	0,9
796/M/16	16 x 16	0,9
796/M/21	21 x 21	0,9



DIRECTORIOS

REF L H

796/M/A4	30 x 21	0,9
796/M/A3	42 x 30	0,9
796/M/A2	60 x 42	0,9

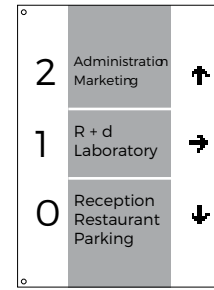
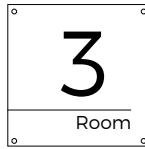
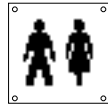

1. Aseos caballeros / Men toilet
2. Aseos señora / Women toilet
3. Aseos / Toilets/restroom
4. Restaurante / Restaurant
5. Cafetería / Coffee shop
6. Teléfono / Téléphone
7. Información / Information
8. Guardarropa / Cloakroom
9. No pasar / Do not cross

10. No fumar / No smoking
11. Flecha / Arrow
13. Ascensor / Lift
14. Diversidad funcional / Functional diversity
15. Sala de reuniones / Mtg. room
16. Subida escaleras / Up stairs
18. Bajada escaleras / Down stairs
20. Sala espera / Waiting room

21. Salida / Way out
22. Entrada / Way in
24. Limpieza / Cleaning room
25. Correos / Post office
36. Ducha / Shower
37. Piscina / Swimming pool
39. Vest. masc. / Men change room
40. Vest. fem. / Women change room

41. Peluquería / Hairdresser
42. Oficina / Office
44. Consigna / Lockers
45. Recepción / Reception
47. Sala TV / TV room
48. Servicios médicos / Medical facilities
49. Hospital / Hospital
50. Silencio / Silence

51. Pto. de encuentro / Mtg. point
52. Biblioteca / Library
54. Escaleras mecánicas / Escalator
60. Fumadores / Smocking room
61. Animales no / No animals entry
64. Enfermería / Infirmary
69. Basuras no / Rubbish bin
74. Fotos no / No cameras
164. Móviles no / No mobile phones



798/M

RÓTULO DE VIDRIO
GLASS SIGN
SIGNÁLETIQUE EN VERRE



Kit de adhesivos de doble cara A
Doubled sided adhesive kit
Kit d'autocollants double face



REF	L	H	REF	L	H	REF	L
798/4/12/M	4 x 12	0.6	798/6/12/M	6 x 12	0.6	A 796/KAR	φ1
798/4/24/M	4 x 24	0.6	798/6/24/M	6 x 24	0.6		
798/4/32/M	4 x 32	0.6	798/6/32/M	6 x 32	0.6		
798/4/48/M	4 x 48	0.6	798/6/48/M	6 x 48	0.6		

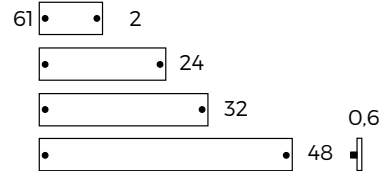
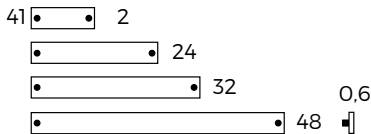

RÓTULO DE VIDRIO

ESP Rótulo fabricado en vidrio templado transparente rotulado mediante vinilo negro. Se fija a la pared atornillando los separadores de acero inoxidable o con kit 796/KAR adhesivos.

GLASS SIGN

ENG Signs made transparent tempered glass and black vinyl. They are fixed to the wall through stainless steel screws or with kit 796/KAR adhesives. You can add pictograms and arrows to chosen text.

SIGNÁLETIQUE EN VERRE

FRA Signalétique en verre transparent pour tout types de présentation. Livrée avec la visserie, fixation rapide avec entretoises en acier inox, optionnel avec kit 796/KAR adhesives. On peut ajouter pictogrammes et flèches d'orientation.



REF	L	H
798/8/12/M	8 x 12	0,6
798/8/24/M	8 x 24	0,6
798/8/32/M	8 x 32	0,6
798/8/48/M	8 x 48	0,6

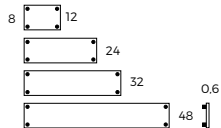

RÓTULO DE VIDRIO

ESP Rótulo fabricado en vidrio templado transparente rotulado mediante vinilo negro. Se fija a la pared atornillando los separadores de acero inoxidable o con kit 796/KAR adhesivos.

REF	L	H
798/12/12/M	12 x 12	0,6
798/12/24/M	12 x 24	0,6
798/12/32/M	12 x 32	0,6
798/12/48/M	12 x 48	0,6

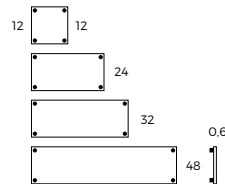

GLASS SIGN

ENG Signs made transparent tempered glass and black vinyl. They are fixed to the wall through stainless steel screws or with kit 796/KAR adhesives. You can add pictograms and arrows to chosen text.

REF	L	H
798/16/24/M	16 x 24	0,6
798/16/32/M	16 x 32	0,6
798/16/48/M	16 x 48	0,6

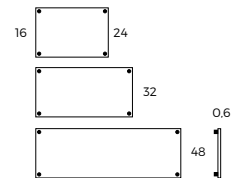

SIGNÁLETIQUE EN VERRE

FRA Signalétique en verre transparent pour tout types de présentation. Livrée avec la visserie, fixation rapide avec entretoises en acier inox, optionnel avec kit 796/KAR adhesives. On peut ajouter pictogrammes et flèches d'orientation.



REF	L	H
GR/12/M	12 x 12	1,6
GR/16/M	16 x 16	1,6
GR/21/M	21 x 21	1,6
GR/A4/M	30 x 21	1,6
GR/A3/M	42 x 30	1,6
GR/A2/M	60 x 42	1,6

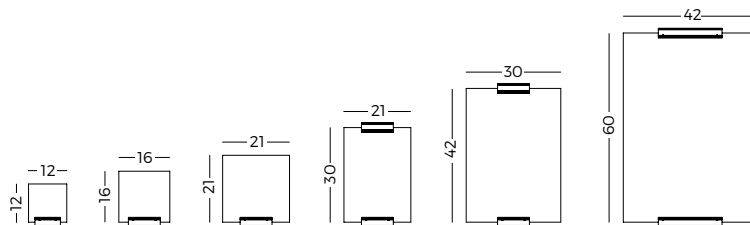

PICTOGRAMAS Y DIRECTORIOS "GRIP"

ESP Sistema de señalización de interiores fabricado en aluminio y vidrio. La pinza "Grip" de aluminio disponible en diversos formatos sujeta el rótulo situado entre el cristal y la traseira metálica. Disponible en versión mural, sobremesa y con soporte.

WALL SIGN "GRIP"

ENG Signing system for the inside in anodized aluminium and glass. The grip is available in various sizes. Wall, table or stand version. Delivered with one allen key. Picto and text not included

SIGNALÉTIQUE MURALE "GRIP"

FRA Système de signalisation d'intérieur en aluminium anodisé et verre. La pince est disponible en divers formats, version murale, sur table ou avec piétement. Livré avec une clé allen. Picto et texte non inclus.



SEÑALIZADOR

REF	L	H
GR/6/12/M	6 x 12	1.6
GR/6/24/M	6 x 24	1.6
GR/6/32/M	6 x 32	1.6
GR/8/12/M	8 x 12	1.6
GR/8/24/M	8 x 24	1.6
GR/8/32/M	8 x 32	1.6
GR/12/24/M	12 x 24	1.6
GR/12/32/M	12 x 32	1.6
GR/12/48/M	12 x 48	1.6

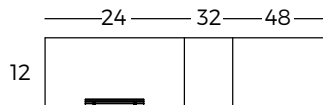
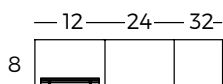
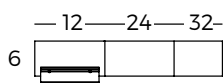

SOPORTE

REF	L	H
GR/10	4 x 10	1.6
GR/20	4 x 20	1.6

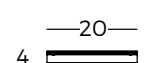

PICTOGRAMAS Y DIRECTORIOS "GRIP"

ESP Sistema de señalización de interiores fabricado en aluminio y vidrio. La pinza "Grip" de aluminio disponible en diversos formatos sujeta el rótulo situado entre el cristal y la traseira metálica. Disponible en versión mural, sobremesa y con soporte.

WALL SIGN "GRIP"

ENG Signing system for the inside in anodized aluminium and glass. The grip is available in various sizes. Wall, table or stand version. Delivered with one allen key. Picto and text not included.

SIGNALÉTIQUE MURALE "GRIP"

FRA Système de signalisation d'intérieur en aluminium anodisé et verre. La pince est disponible en divers formats, version murale, sur table ou avec piétement. Livré avec une clé allen. Picto et texte non inclus.



GR/SB

RÓTULOS DE SOBREMESA
SIGN FOR TABLE
SIGNALÉTIQUE SUR TABLE



REF L H

GR/6/12/SB	6 x 12	4,5
GR/8/24/SB	8 x 24	4,5
GR/16/SB	16 x 16	4,5
GR/A4/SB	30 x 21	4,5

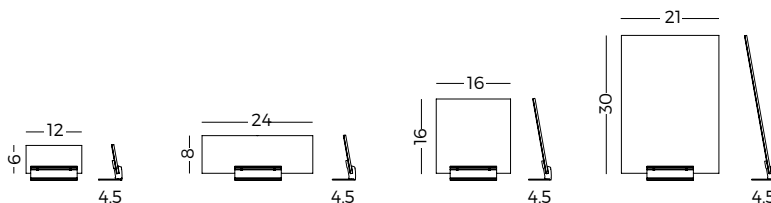

RÓTULOS DE SOBREMESA "GRIP"

ESP Sistema de señalización de interiores fabricado en aluminio y vidrio. La pinza "Grip" de aluminio disponible en diversos formatos sujeta el rótulo situado entre el cristal y la traseira metálica. Disponible en versión mural, sobremesa y con soporte.

SIGN FOR TABLE "GRIP"

ENG Signing system for the inside in anodized aluminium and glass. The grip is available in various sizes. Wall, table or stand version. Delivered with one allen key. Picto and text not included

SIGNALÉTIQUE SUR TABLE "GRIP"

FRA Système de signalisation d'intérieur en aluminium anodisé et verre. La pince est disponible en divers formats, version murale, sur table ou avec piétement. Livré avec une clé allen. Picto et texte non inclus.



ROTUPLAN

PICTOGRAMAS Y DIRECTORIOS
WALL SIGN
SIGNALÉTIQUE MURALE

GR/P

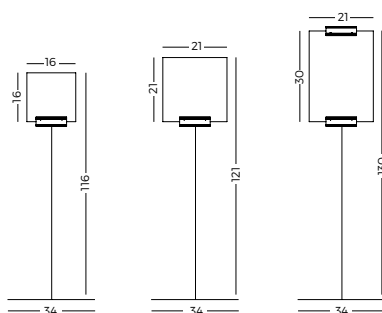
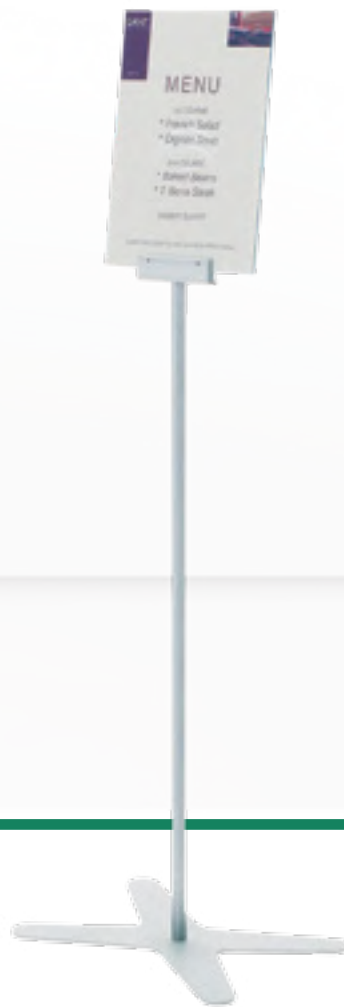

REF L --

GR/16/P	16 x 16	116
GR/21/P	21 x 21	121
GR/A4/P	30 x 21	130



RÓTULOS "GRIP" CON SOPORTE

ESP Sistema de señalización de interiores fabricado en aluminio y vidrio. La pinza "Grip" de aluminio disponible en diversos formatos sujeta el rótulo situado entre el cristal y la trasera metálica. Disponible en versión mural, sobremesa y con soporte.

TAGLINE "GRIP" WITH SUPPORT

ENG Signing system for the inside in anodized aluminium and glass. The grip is available in various sizes. Wall, table or stand version. Delivered with one allen key. Picto and text not included.

SIGNALÉTIQUE "GRIP" SUR PIÈTEMENT

FRA Système de signalisation d'intérieur en aluminium anodisé et verre. La pince est disponible en divers formats, version murale, sur table ou avec piètement. Livré avec une clé allen. Picto et texte non inclus.



TY

PICTOGRAMA INOX ADHESIVO
 PICTOGRAM INOX ADHESIVE
 PICTOGRAMME INOX ADHÉSIF



LETRAS

REF	L	H
TY/L/...	8.5 x 5.1	0.25

NÚMEROS

REF	L	H
TY/N/...	8.5 x 5.1	0.25

PICTOGRAMAS

REF	L	H
TY/P/...	10.6	0.25

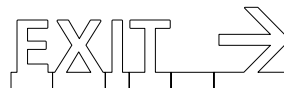
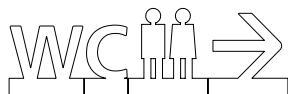

PICTOGRAMAS "TYPO" INOX ADHESIVOS

ESP Pictogramas, letras y números adhesivos fabricados en acero inoxidable de 0.25 cm. Gracias a su fácil colocación permiten señalar cualquier entorno formando palabras y/o unir varios números o pictogramas. Aplicar sobre una superficie lisa.

PICTOGRAM "TYPO" INOX ADHESIVE

ENG Pictograms, letters and numbers in stainless steel 0.25 cm "Typo". Easy and fast installation on a slick surface thanks to a double-sided adhesive tape. For the inside and semi-outdoor. Can be combined in order to compose words or series of numbers.

PICTOGRAMME "TYPO" INOX ADHÉSIF

FRA Pictogrammes, lettres et numéros en acier inoxydable de 0,25 cm "Typo". Installation simple et rapide sur une surface lisse grâce à un adhésif double face. Pour intérieur et semi-extérieur. peuvent être combinés pour former des mots ou suites de chiffres.



LETRAS

REF	L	H
TY/L/A	8,5 x 5,1	0,25
TY/L/B	8,5 x 5,1	0,25
TY/L/C	8,5 x 5,1	0,25
TY/L/Ç	8,5 x 5,1	0,25
TY/L/D	8,5 x 5,1	0,25
TY/L/E	8,5 x 5,1	0,25
TY/L/F	8,5 x 5,1	0,25
TY/L/G	8,5 x 5,1	0,25
...	8,5 x 5,1	0,25
TY/L/Z	8,5 x 5,1	0,25



NÚMEROS

REF	L	H
TY/N/0	8,5 x 5,1	0,25
TY/N/1	8,5 x 5,1	0,25
TY/N/2	8,5 x 5,1	0,25
TY/N/3	8,5 x 5,1	0,25
TY/N/4	8,5 x 5,1	0,25
TY/N/5	8,5 x 5,1	0,25
TY/N/6	8,5 x 5,1	0,25
TY/N/7	8,5 x 5,1	0,25
TY/N/8	8,5 x 5,1	0,25
TY/N/9	8,5 x 5,1	0,25



PICTOGRAMAS

REF	L	H
TY/P/AHM	10,6	0,25
TY/P/AH	10,6	0,25
TY/P/AM	10,6	0,25
TY/P/AMI	10,6	0,25
TY/P/AS	10,6	0,25
TY/P/PS	10,6	0,25
TY/P/PE	10,6	0,25
TY/P/CO	10,6	0,25
...
TY/P/FL	10,6	0,25

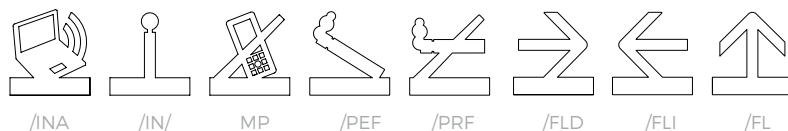
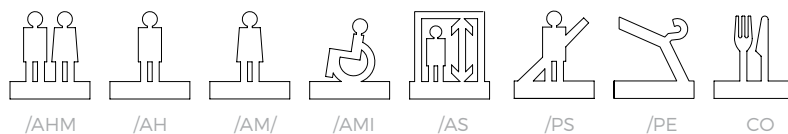
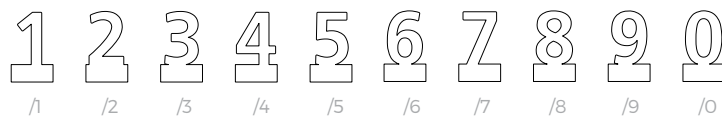
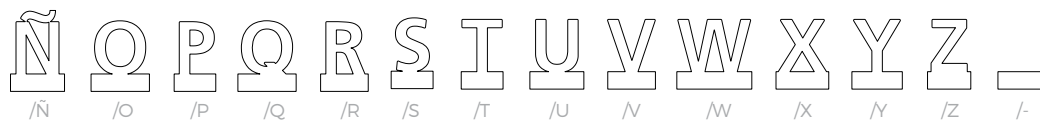

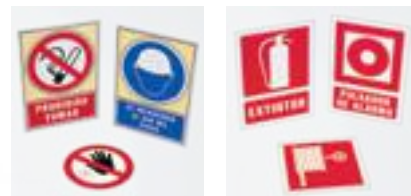

A4			A3			21-10		
REF	L	H	REF	L	H	REF	L	H
795/A4/...	42 x 29.7	0.2	795/A3/...	42 x 29.7	0.2	795/21/...	21 x 21	0.2
795/A4/F/...	42 x 29.7	0.2	795/A3/F/...	42 x 29.7	0.2	795/21/F/...	21 x 21	0.2
795/A4+/...	49 x 34.5	0.2	795/A3+/...	49 x 34.5	0.2	795/10/...	10.5 x 29.7	0.2
						795/10/F/...	10.5 x 29.7	0.2

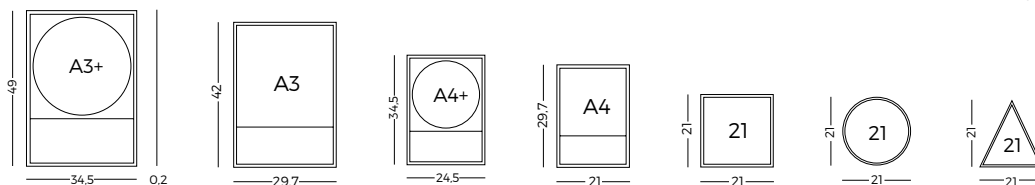

SEÑALIZACIÓN NORMALIZADA

ESP Placas DIN A4, DIN A3 y cuadradas de 21 x 21 cm. fabricadas en aluminio lacado y serigrafiado según normativa para la señalización de prevención de riesgos laborales.
 (Real decreto 485/1997 del 14 de Abril) UNE 81-501-81 / UNE 23-033-81 / UNE 23-034-88.

ATTENTION SIGNS EMERGENCY

ENG Printed signs in A4, A3 and squares of 21 x 21 cm. are made with lacquered aluminium printed to notify regulations, laws and prevention awareness.
 (Decree 485/1997 of April 14th) UNE 81-501-81 / UNE 23-033 81 / UNE 23-034-88.

PICTOGRAMME "TYPO" INOX ADHÉSIF

FRA Panneaux A4, A3 et carrés 21 x 21 cm. en aluminium laqué et sérigraphie conformes aux normes européennes pour la signalisation de sécurité et la santé sur les lieux de travaux.
 (Décret 485/1997 14 avril) UNE 81-501-81 / UNE 23-033-81 / UNE 23-034-88.

SALIDA

REF	A3	A4	21 x 21
616	✓	✓	-
617	✓	✓	-
623	✓	✓	-
631	✓	✓	-
632	✓	✓	-
633	✓	✓	-
645	✓	✓	-
647	-	-	✓
650	-	-	✓
651	-	-	✓
652	-	-	✓
653	-	-	✓
654	-	-	10,5 x 29,7



EXTINCIÓN

REF	A3	A4	21 x 21
504	✓	✓	-
510	✓	✓	-
511	✓	✓	-
523	✓	✓	-
524	✓	✓	✓
525	✓	✓	✓
529	✓	✓	✓
530	✓	✓	✓



PELIGRO

REF	A3+	A4+	21 x 21
201	✓	✓	✓
203	✓	✓	✓
207	✓	✓	✓
208	✓	✓	✓
524	✓	✓	✓
525	✓	✓	✓
529	✓	✓	✓
530	✓	✓	✓



PROHIBICIÓN

REF	A3+	A4+	21 x 21
105	✓	✓	o/□
106	✓	✓	o/□
111	✓	✓	o/□
109	✓	✓	o/□
124	✓	✓	□/✓
141	✓	✓	□/✓
607	✓	✓	o/□
608	✓	✓	□/✓



OBLIGACIÓN

REF	A3+	A4+	21 x 21
301	✓	✓	o/□
302	✓	✓	o/□
304	✓	✓	o/□
305	✓	✓	o/□
306	✓	✓	o/□
312	✓	✓	o/□
1821/S	✓	✓	□/✓
1822/S	✓	✓	□/✓

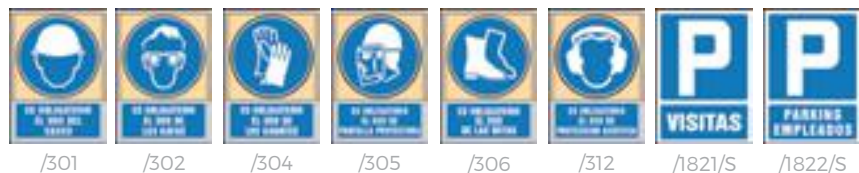



07

PROYECPLAN

PRESENTACIÓN VISUAL
VISUAL PRESENTATION
PRÉSENTATION VISUELLE



REF	whiteboard	ITV	
ITV/01	130 x 200	VDP/7/10	87
ITV/02	120 x 200	VDP/6/2	87

*Soporte para proyector incluido / Projector stand included



DISPOSITIVO INTERACTIVO

ESP Dispositivo interactivo, portátil. Convierte su pizarra blanca o verde tradicional en una PDI (Pizarra Digital Interactiva). Permite capturar instantáneamente todo lo que se escribe sobre ella y enviarlo a un PC. La escritura queda memorizada.

INTERACTIVE PORTABLE SYSTEM

ENG Interactive device, portable. Turn your whiteboard into a PDI (interactive whiteboard). Instantly Capture everything you write on it and send it to a PC. The script is stored.

BARRE PORTABLE INTÉRACTIVE

FRA Dispositif portable. Transformez votre tableau blanc ou vert traditionnel en PDI (tableau blanc interactif). Capturez instantanément tout ce que vous écrivez dessus et l'envoyer vers un PC pour y être stocké.



PACK ITV/01
DESCR.

ESP Pizarra blanca mate 130 x 200 cm.
+ Videoprojector VPD/7/10
+ Soporte

ENG Matt whiteboard 130 x 200 cm.
+ Video projector VPD/7/10
+ Support

FRA Tableau blanc mat 130 x 200 cm.
+ Vidéoprojecteur VPD/7/10
+ Support



PACK ITV/02
DESCR.

ESP Pizarra 720/6/M - 120 x 200 cm.
+ Videoprojector VPD/6/2 + Soporte
+ 1 lápiz digitales

ENG Whiteboard 720/6/M - 120 x 200 cm.
+ Video projector VPD/6/2 + Support
+ 1 digital pen

FRA Tableau 720/6/M - 120 x 200 cm.
+ Vidéoprojecteur VPD/6/2 + Support
+ 1 digital pen



MIMIO TECH

REF Características

MIMIO/T MIMIO Teach + Digital pen
MIMIO/CP Kit MIMIO Capture



KIT ITV

REF L

KIT/ITV 10 x 10 Kit conexión USB
USB kit connection
Kit connexion USB



VPD

VIDEOPROYECTORES
 VIDEOPROJECTOR
 VIDÉO PROJECTEURS



REF	L	Res.	ANSI Lumens	REF	L	Res.	ANSI Lumens
A VPD/1	34,9 x 24,7 x 10,5	XGA	2200	D VPD/4	35,0 x 38,2 x 14,3	XGA	2000
B VPD/2	34,9 x 24,7 x 10,5	XGA	3000	E VPD/5	32,1 x 38,5 x 17,8	WXGA	3000
C VPD/3	37,9 x 30,5 x 10,7	XGA	5000				

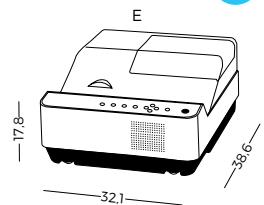
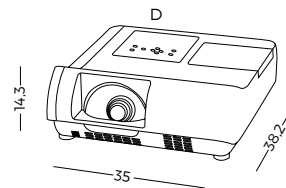
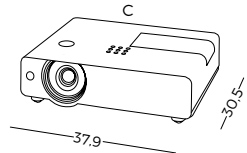
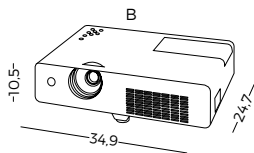
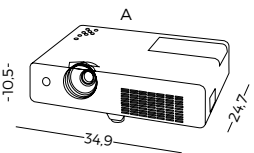

VIDEOPROYECTORES

ESP Videoproyectores compactos y portátiles de altas prestaciones indicado para instalaciones o presentaciones móviles. Éstos proyectores tienen un uso polivalente tanto para la educación como en empresas por su portabilidad, y ofrecen gran luminosidad.

VIDEO PROJECTOR

ENG Portable compact video projectors with high performance suitable for installations or mobile presentations. These projectors have a multipurpose use for education and for the company due to its portability, and offers high luminosity.

VIDÉO PROJECTEURS

FRA Gamme complète de vidéoprojecteurs polyvalent pour l'éducation et les entreprises. Performants, léger et très lumineux, vous y trouverez un produit adapté, une entrée, un moyen et un haut de gamme.



PROYECPLAN

VIDEOPROYECTORES
 VIDEOPROJECTOR
 VIDÉOPROJECTEURS

VPD



REF	L	Res.	ANSI Lumenes	Touch
VPD/6/2	38,3 x 30,8 x 8,6	WXGA	3300	Bolígrafo táctil
VPD/7/10	38,3 x 30,8 x 8,6	WXGA	3300	Táctil

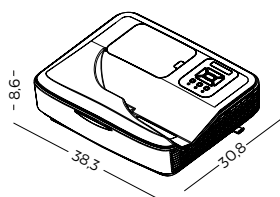

VIDEOPROYECTORES

ESP Videoproyectores compactos y portátiles de altas prestaciones indicado para instalaciones o presentaciones móviles. Éstos proyectores tienen un uso polivalente tanto para la educación como en empresas por su portabilidad, y ofrecen gran luminosidad.

VIDEO PROJECTOR

ENG Portable compact video projectors with high performance suitable for installations or mobile presentations. These projectors have a multipurpose use for education and for the company due to its portability, and offers high luminosity.

VIDÉO PROJECTEURS

FRA Gamme complète de vidéoprojecteurs polyvalent pour l'éducation et les entreprises. Performants, léger et très lumineux, vous y trouverez un produit adapté, une entrée, un moyen et un haut de gamme.



410

SOPORTES AJUSTABLES
ADJUSTABLE BRACKETS
SUPPORT PLAFOND INCLINABLE



REF	↑	→
410/06/100	8/98	22



12 Kg. máx.

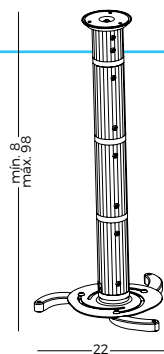

REF	↑	→
410/06	17	22

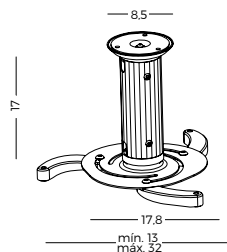

REF	↑	→
410/20	20.3	73/123

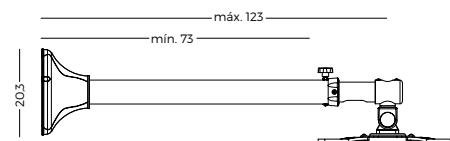

SOPORTES AJUSTABLES

ESP Soporte metálico de fijación a techo o pared para videoproyectores con un máximo de 13,6 kg. Acabado en color gris metalizado.

ADJUSTABLE BRACKETS

ENG Ceiling brackets for videoprojector up to 13,6 Kg. Suitable for most of the projectors thanks to 3 or 4 arms mounting pattern. Easy to install thanks to a hook-in system.

SUPPORTS RÉGLABLES

FRA Support métallique se fixant au plafond ou au sol pour vidéoprojecteurs jusqu'à 13,6 Kg. Finition gris métallisé.



PANTALLA CON TRÍPODE
TRIPOD PROJECTOR SCREEN
ÉCRAN DE PROJECTION SUR PIED

PT



REF	L	H	P
PT/T1	270	150 x 150	13.5
PT/T2	270	180 x 180	13.5

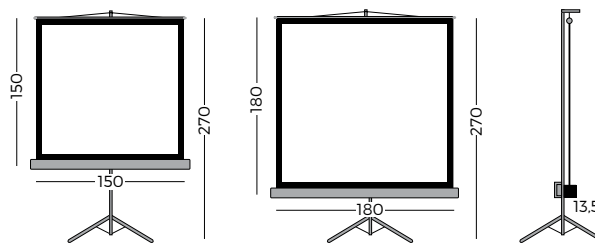

PANTALLA CON TRÍPODE "BASIC"

ESP Pantalla de proyección con trípode. La carcasa de gran diseño, está fabricada en chapa plastificada color blanco y la tela es especial antirreflectante. Posee brazo inclinable para corregir la distorsión de la imagen. Estructura plegable. Ganancia: 1.3. Tela M1.

TRIPOD PROJECTOR SCREEN "BASIC"

ENG Tripod projector screen. The design casing is made entirely of white laminated sheet metal and the fabric is antiglare. Easy to install and to use. The screen has an adjustable inclined bracket to correct image distortion. Foldable structure. Gain 1.3. Fabric M1.

ÉCRAN DE PROJECTION SUR TRÉPIED "BASIC"

FRA Écran de projection sur trépied avec potence télescopique et correction de parallaxe. Carter en tôle plastifiée blanc non réfléchissant. Grande qualité d'image, la toile blanc mat de gain 1.3 est ignifugé M1. Déroulement simple et rapide à la mesure souhaitée.



PM

PANTALLA MURAL
WALL PROJECTOR SCREEN
ÉCRAN DE PROJECTION



PANTALLA

REF	↕	↔
PM/T1	147 x 147	14
PM/T2	177 x 177	14
PM/T3	200 x 200	14
PM/T4	240 x 240	14

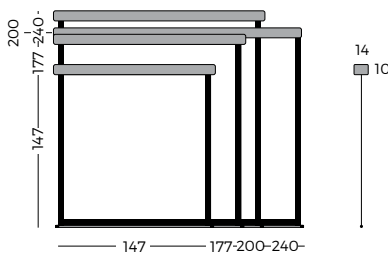

SEPARADOR DE PARED

REF	↔
SP/1	1 - 15cm
SP/2	1 - 35cm



PANTALLA MURAL "BASIC"

ESP Pantalla mural de proyección, adaptable a techo y pared. La carcasa está fabricada en chapa plastificada color blanco y la tela es especial antirreflectante. La tela se puede desenrollar a la medida deseada y el enrollado es automático. Ganancia: 1,3. Tela M1.

WALL PROJECTOR SCREEN "BASIC"

ENG Projector screen for the ceiling and wall. The design casing is made entirely of white laminated sheet metal and the fabric is anti-glare. The fabric can be unrolled to the wished measurement and the rolling up is automatic. Gain 1,3. Fabric M1.

ÉCRAN DE PROJECTION "BASIC"

FRA Écran de projection manuel, fixation murale et/ou plafond. Carter en tôle plastifiée blanc non réfléchissant. Grande qualité d'image, la toile blanc mat de gain 1,3 est ignifugé M1. Déroulement simple et rapide à la dimension souhaitée.



PROYECPLAN

PANTALLA MURAL ELÉCTRICA
ELECTRICAL PROJECTION SCREEN
ÉCRAN DE PROJECTION ÉLECTRIQUE

PMM

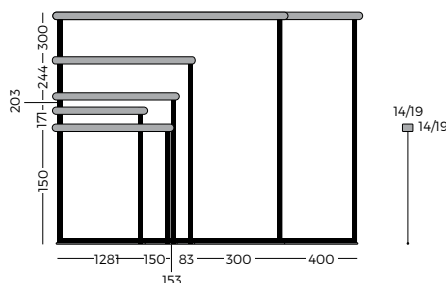

REF □ ▨

PMM/10	150 x 150	14
PMM/11	177 x 177	14
PMM/12	200 x 200	14
PMM/13	240 x 240	19
PMM/14	300 x 300	19
PMM/15	300 x 400	19

*Mando a distancia incluido / Remote control included



PANTALLA MURAL ELÉCTRICA

ESP Pantalla mural de elevación automática por medio de un motor eléctrico adaptable a techo y pared. La carcasa está fabricada en aluminio y la tela es especial antirreflejante. El funcionamiento de la pantalla se acciona mediante un interruptor manual.

ELECTRICAL PROJECTION SCREEN

ENG Wall or ceiling projection screen. Roll-up mechanism driven through an electrical motor. The design casing is made entirely of aluminium and the fabric is anti-glare. A manual switch (included) or remote controls (optional). Gain 1.3. Fabric M1.

ÉCRAN DE PROJECTION ÉLECTRIQUE

FRA Écran de projection motorisée. Fixation murale ou plafond. Moteur à vitesse de rotation élevée, permettant une mise en place de l'écran très rapide. Carter en aluminium anodisé de couleur gris, anti-reflets Interrupteur manuel (inclus). Gain 1,3 est ignifugé M1.



ION/Z

SOPORTE PANTALLA DE SOBREMESA
 SCREEN SUPPORT
 SUPPORT POUR ÉCRAN À POSER

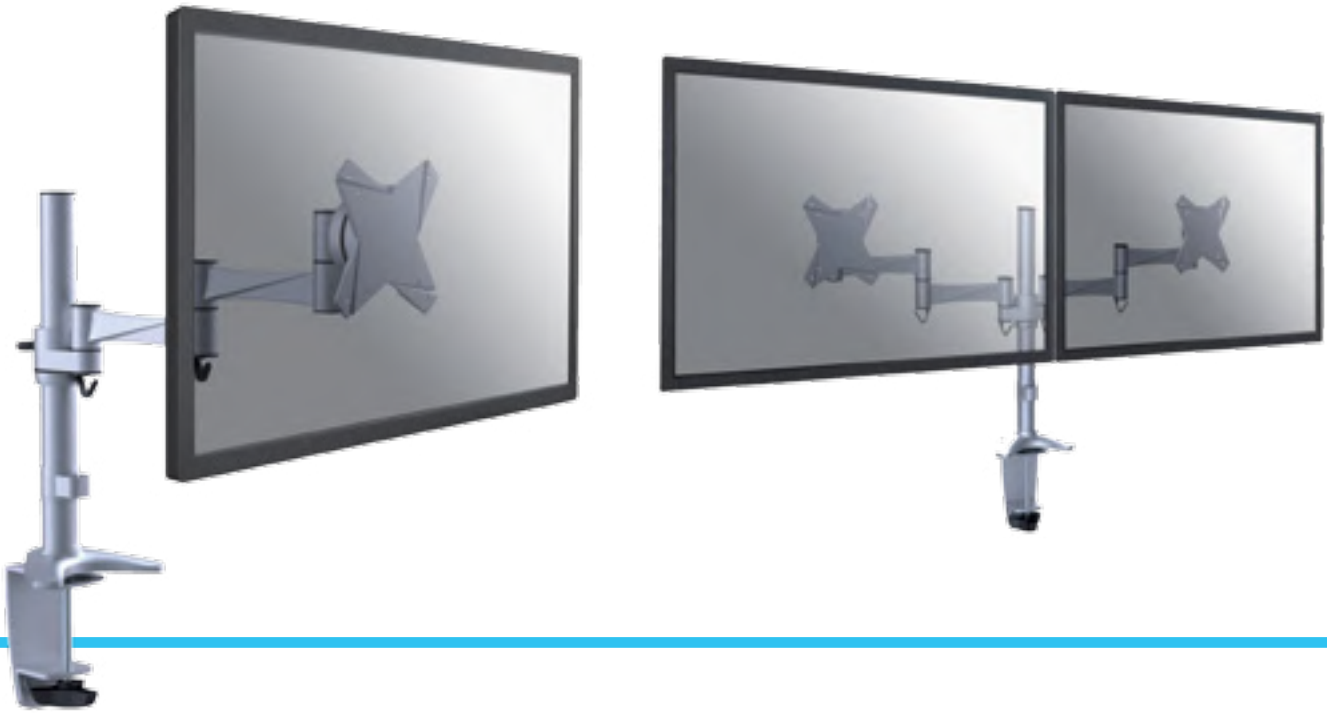

REF | ← VESA min. VESA max.

ION/Z/102	51	42,7	75 x 75	100 x 100
ION/Z/102/TW	51	85,4	75 x 75	100 x 100



*Por cada soporte/ For any support

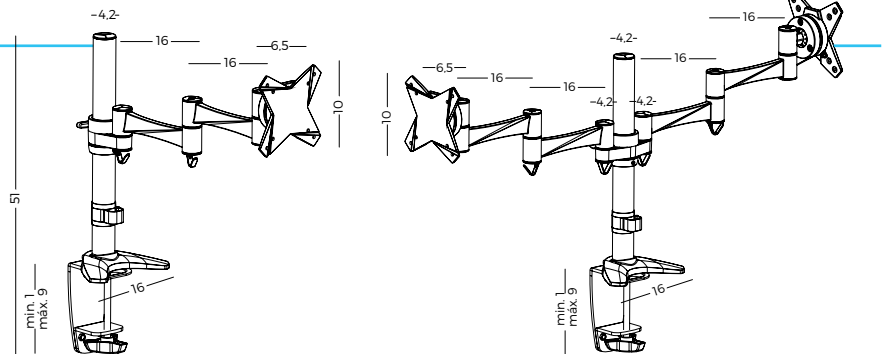

SOPORTE PANTALLA DE SOBREMESA "ZOOM"

ESP Serie ergonómica de brazos y soportes de sobremesa metálicos para pantallas de LCD / plasma hasta 24 pulgadas y un máximo de 18kg. (2 x 9kg.) Incluyen sistema de extensión VESA y clip pasacables. Acabado en color gris metalizado.

SCREEN SUPPORT "ZOOM"

ENG An ideal solution for LCD/Plasma up to 24 inch, and maximum mounting 18kg.(2 x 9kg.) distinguished by its high quality design aesthetic. Featuring an integral ball joint, it offers the possibility of rotating the screens through 360°, in addition to a tilting range of 15°, up or down. Height adjustable.

SUPPORT POUR ÉCRAN À POSER "ZOOM"

FRA Platines murales universelles et supports de table pour écrans LCD/Plasma jusqu'à 28 pouces et 20 Kg. Comprend un système d'extension VESA et un anneau passe-cables électriques. Finition gris métallisé.



SOPORTE PANTALLA MURAL WALL BRACKETS FOR SCREENS PLATINE MURALE POUR ÉCRAN

ION

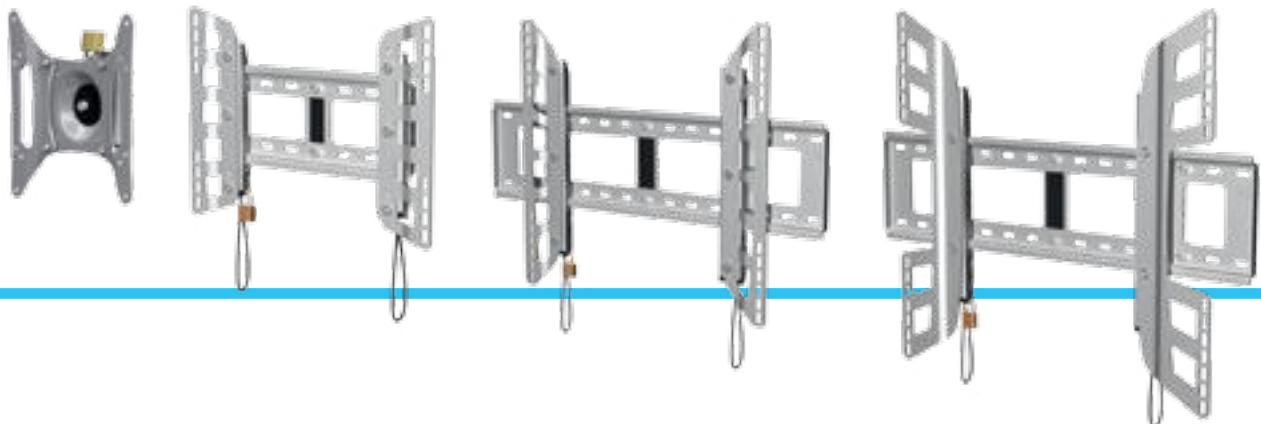

REF	L	+	-
ION/TR	22 x 20		5,8

32" máx. 30 Kg. máx.

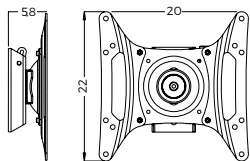

REF	L	+	-
ION/PL	33,6 x 44,4		3,7

52" máx. 75 Kg. máx.

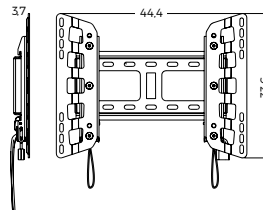

REF	L	+	-
ION/PL/XL	53 x 85		3,7

60" máx. 80 Kg. máx.

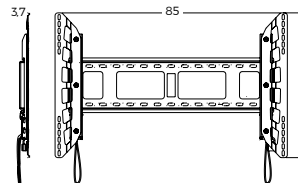

REF	L	+	-
ION/TR	60 x 85		3,7

65" máx. 80 Kg. máx.

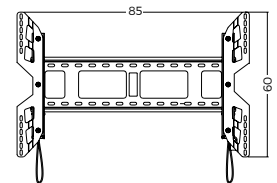

SOPORTE PANTALLA MURAL

ESP Serie de soportes murales metálicos para pantallas de LCD / plasma de 32 hasta 65 pulgadas y un máximo de 80 kg. Incluyen sistema de seguridad con candado. Acabado en color gris metalizado. Ideal para grandes formatos (XL y XXL).

WALL BRACKETS FOR SCREENS

ENG Wall brackets for screens up to 32 / 65 inch with a maximum weight of 80 Kg. Possibility to swivel and tilt 30°. Equipped with security lock.

PLATINE MURALE POUR ÉCRAN

FRA Platinas murales metálicas pour écrans LCD/Plasma jusqu'à 32 / 65 pouces et un maximum de 80 Kg. Comprend un système de sécurité avec cadenas. Finitions gris métallisé.



CEILING

SOPORTE LCD/PLASMA DE TECHO
CEILINGS BRACKETS LCD/PLASMA
SUPPORT PLAFOND POUR ÉCRAN

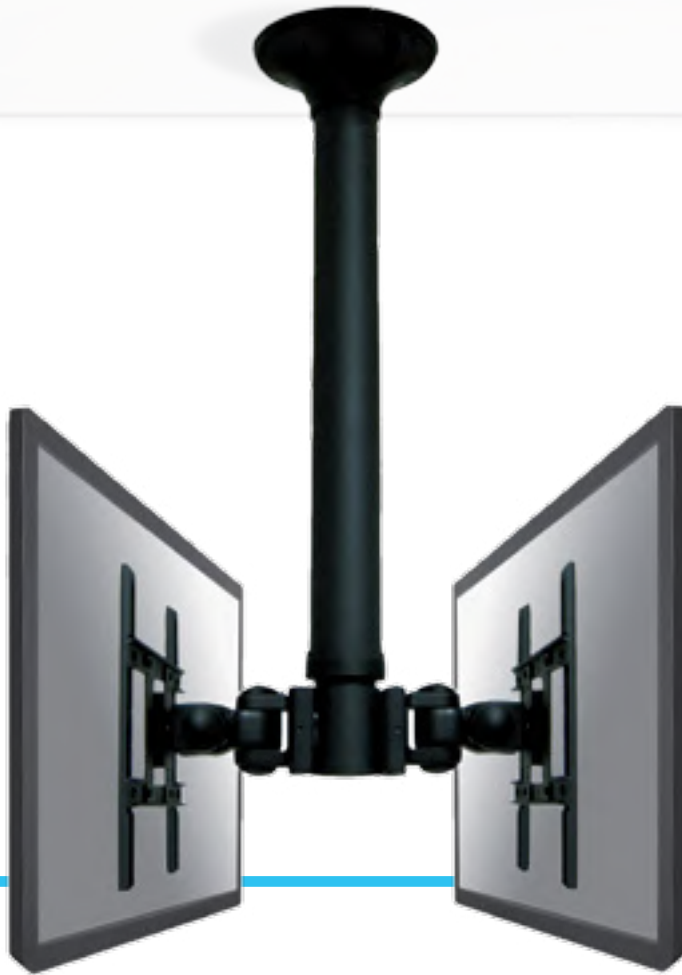

REF | — VESA min. VESA max.

ION/C/XL	64/104	16	75 x 75	200 x 200
ION/C/TW/XL	64/104	32,5	75 x 75	200 x 200



*Por cada soporte/ For any support

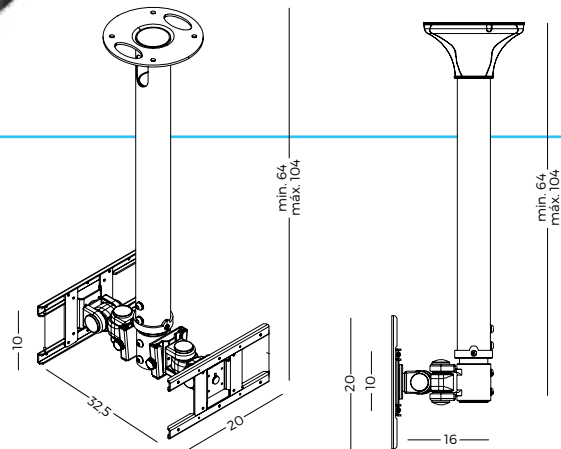

SOPORTE LCD/PLASMA DE TECHO "CEILING"

ESP Serie ergonómica de brazos y soportes metálicos de fijación suspendida a techo, para pantallas de LCD / plasma hasta 40 pulgadas y un máximo de 20 kg. Incluyen sistema de extensión VESA y clip pasacables. Acabado en color gris metalizado.

CEILINGS BRACKETS LCD/PLASMA "CEILING"

ENG Ceilings brackets for LCD/Plasma screens until 40 inch VESA extension for a maximum mounting 20 kg. Adjustable height.

SUPPORT PLAFOND POUR ÉCRAN "CEILING"

FRA Supports plafond sur platine pour écrans LCD/Plasma jusqu'à 40 pouces et 20 Kg. Comprend un système d'extension VESA et des goulottes pour câbles électriques. Finition gris métallisé.



SOPORTE PARA TV GRADUABLE Y MÓVIL
SUPPORT FOR ADJUSTABLE AND MOBILE TV
SUPPORT POUR ÉCRAN

TVS

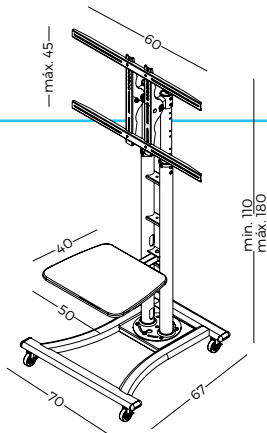

COLOR ESTANTE

●
/NG

REF	L	Shelf	VESA min.	VESA max.
TVS/N	180 x 110	1	200 x 200	600 x 450



SOPORTE PARA TV GRADUABLE Y MÓVIL

ESP Soporte móvil para TV, pantalla y monitores de gran robustez, que incorpora un estante graduable en altura. Disponible en color gris y negro. Ideal para salas de formación, centros de convenciones, etc... Incluye estante.

SUPPORT FOR ADJUSTABLE AND MOBILE TV

ENG Mobile stand for TV screen and monitors really robust, incorporating or adjustable height shelf. Available in grey and black. Ideal for training rooms, convention halls, etc... Shelf included.

SUPPORT POUR ÉCRAN

FRA Support mobile pour écrans de télévision et moniteurs très robuste, incorpore une étagère réglable en hauteur. Disponible en gris et noir. Idéal pour les salles de formation, centres de congrès, etc...



TROLEY

MESAS DE PROYECCIÓN
PROJECTOR TROLLEYS
TABLES DE RÉTROPROJECTION



REF ↑ L ⇄

A	MM	60/95	60 x 55	1,9
B	MP	60/95	60 x 55	1,9

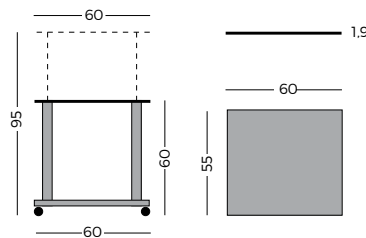

A

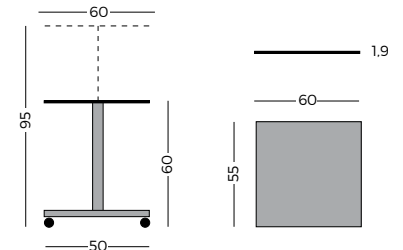

B

MESAS DE PROYECCIÓN

ESP Mesa de proyección cómoda y ligera, con ruedas multidireccionales, provistas de freno las delanteras. Toda la gama de mesas tienen la estructura metálica pintada en color gris, y los tableros son de madera melaminada.

PROJECTOR TROLLEYS

ENG With a modern design suitable for all OHPs, this functional grey metallic mobile trolley features a laminated tabletop for storage of accessories and equipment, and 4 fully circular castors (lockable front castors).

TABLES DE RÉTROPROJECTION

FRA Table de projection légère et stable. Conception en métal gris et plateau en mélaminé. Equipée de 4 roulettes pivotantes dont 2 avec freins, qui assurent mobilité et stabilité. Plateau télescopique réglable en hauteur. Idéale pour n'importe quel type de projecteur



ATRIL Y SOPORTE PORTA IPAD
LECTERN AND IPAD HOLDER SUPPORT
CHEVALET ET SUPPORTS POUR IPAD

600

**DE PIE**

REF	Tablet	↑	└
600/IP/NG	23 x 28	110	36 x 36
600/IP/BL	23 x 28	110	36 x 36

DE PARED

REF	Tablet	↑
600/IM/NG	23 x 28	40
600/IM/BL	23 x 28	40

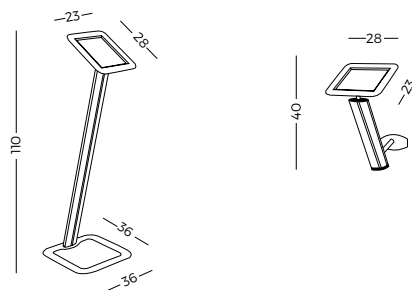
**ATRIL Y SOPORTE PORTA IPAD**

ESP Gama de atriles y soportes de aluminio porta iPad. Disponible en versión de pié y mural. Ideal para comercios, showrooms, ferias y convenciones. El sistema incorpora dispositivo de seguridad antirrobo.

LECTERN AND IPAD HOLDER SUPPORT

ENG Range of lectern and display in aluminium tube for iPad holder. Available in wall and floor versions. Ideal for shops, showrooms, exhibitions and conventions. The system incorporates anti-theft device.

CHEVALET ET SUPPORTS POUR IPAD

FRA Gamme de chevalet et supports en aluminium tubulaire pour iPad. Disponible en version murale et sur pié. Idéal pour magasins, salles d'exposition, salons et congrès. Le système comprend un antivol.



ICONOS

ICONOS
ICONS
ICONES



Rotulable
Inscribable
Inscriptable



No rotulable
Not inscribable
Non-inscriptable



Escritura con tiza
Chalk writing
Ecriture à la craie



Trazo digital
Digital use
Trait digital



Blocs de papel
Paper blocs
Blocs du papier



Personalizable
Customizable
Personnalisé



Magnético
Magnetic
Magnétique



No magnético
Not magnetic
Non-magnétique



Perforable
Suitable for pins
Aptes aux punaises



Adhesivo
Adhesive
Adhésif



Doble cara
Double sided
Double face



Sujección incluida
Fitting included
Ferrures inclus



Puerta abatible vert.
Vert. swing door
Portes battante vert.



Puerta abatible hor.
Hor. swing door
Portes battante hor.



Incluye ruedas
Castors included
Avec roulettes



Incluye nivelador
Adjustable base
Socles ajustables



Ajustable en altura
Adjustable height
Régable en hauteur

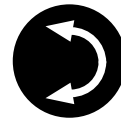

Volteable
Flip - flop
Volteable



Puerta corredera
Sliding doors
Portes coulissantes



Incluye cerradura
Lock included
Serrure incluse



Sistema seguridad
Security system
Serrure de sécurité



Resistente
Weatherproof
Résistant



Inflamable
Flammable
Inflammable



Kit de iluminación
Light kit
Kit lumière

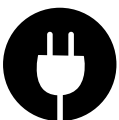

Incluye cable
Cable included
Câbles inclus



Incluye herramientas
Tools included
Visserie inclus

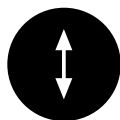

Incluye nivelador
Adjustable base
Socles ajustables



Acústico
Acoustic
Acoustique

1 Borrador en seco
Dry - wipe
Effaçables à sec

2 Doble cara
Double sided
Double face

3 Colores
Colours
Couleurs



GAMA DE COLORES
COLOUR CHART
COULEURS

COLORES PS



Pizarra - /BL
Whiteboard - /BL
Tableau - /BL



Pizarra verde - /VD
Green board - /VD
Tableau vert - /VD



Pizarra azul - /AZ
Blue board - /AZ
Tableau bleu - /AZ



Pizarra negra - /NG
Black board - /NG
Tableau noir - /NG



Pizarra gris - /GR
Grey board - /GR
Tableau gris - /GR

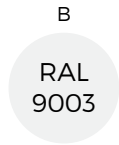

Blanco - /BL
White - /BL
Blanc - /BL



Gris - /GR
Grey - /GR
Gris - /GR

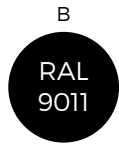

Negro - /NG
Black - /NG
Noir - /NG

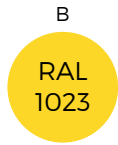

Amarillo - /AM
Yellow - /AM
Jeune - /AM



Rojo - /RJ
Red - /RJ
Rouge - /RJ



Azul - /AZ
Blue - /AZ
Bleu - /AZ



Verde - /VD
Green - /VD
Vert - /VD

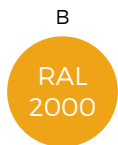

Naranja - /NJ
Orange - /NJ
Orange - /NJ

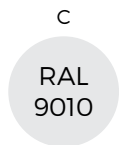

Blanco - 01
White - 01
Blanc - 01

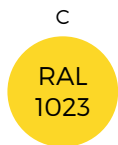

Amarillo - 29
Yellow - 29
Jeune - 29



Naranja - 34
Orange - 34
Orange - 34



Rojo - 19
Red - 19
Rouge - 19



Burdeos - 55
Bordeaux - 55
Bordeaux - 55



Verde - 78
Green - 78
Vert - 78

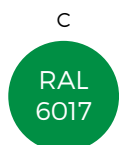

Verde oscuro - 20
Dark green - 20
Vert foncé - 20

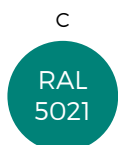

Turquesa - 76
Turquoise - 76
Turquoise - 76

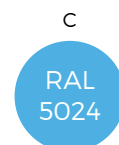

Azul - 76
Blue - 76
Bleu - 76

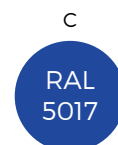

Azul oscuro - /AZ
Dark blue - /AZ
Bleu foncé - /AZ

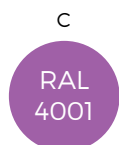

Violeta - 63
Violet - 63
Violet - 63



Gris - 70
Grey - 70
Gris - 70

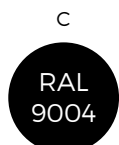

Negro - 57
Black - 57
Noir - 57



Negro - /NG
Black - /NG
Noir - /NG



Burdeos - /BD
Budeaux - /BD
Budeaux - /BD



Azul - /AZ
Blue - /AZ
Bleu - /AZ



Verde - /VD
Green - /VD
Vert - /VD



Gris - /GR
Grey - /GR
Gris - /GR



Ocre - /OC
Ochre - /OC
Ocre - /OC

A
Superficie pizarras
Whiteboard surface
Tableau surface

B
Color del lacado
Lacquer colour
Couleur laquée

C
Color rotulación
Sign system colours
Couleur signalétique

D
Color tapizado
Fabric color
Couleur tapissé



PERSONALIZACIÓN

PERSONALIZACIÓN
CUSTOMIZATION
PERSONNALISATION



IMÁGEN CORPORATIVA

CORPORATE IDENTITY | IMAGE DE MARQUE

ESP Te ofrecemos la posibilidad para añadir detalles al producto para que se ajusten a la imagen corporativa de tu empresa o marca. **Pintar un producto en un color concreto o añadir un logotipo, ilustración o texto en vinilo o serigrafía** son dos posibilidades para adaptar los diseños de Planning Sislamo y que encajen en la estética deseada.

ENG Te ofrecemos la capacidad para añadir detalles al producto para que se ajusten a la imagen corporativa de tu empresa o marca. **Pintar un producto en un color concreto o añadir un logotipo, ilustración o texto en vinilo o serigrafía** son dos posibilidades para adaptar los diseños de Planning Sislamo i que encajen en la estética deseada.

FRA Te ofrecemos la capacidad para añadir detalles al producto para que se ajusten a la imagen corporativa de tu empresa o marca. **Pintar un producto en un color concreto o añadir un logotipo, ilustración o texto en vinilo o serigrafía** son dos posibilidades para adaptar los diseños de Planning Sislamo i que encajen en la estética deseada.

CARACTERÍSTICAS

CHARACTERISTICS | CARACTERISTIQUES

ESP Existe la posibilidad de cambiar características a un producto para que su uso sea viable en cualquier entorno: aplicar tratamientos de cataforesis para productos de exterior, cambio de materiales, medidas, detalles o accesorios. Capacidad para fabricar un producto único que se ajuste a sus necesidades.

ENG Existe la posibilidad de cambiar características a un producto para que su uso sea viable en cualquier entorno: aplicar tratamientos de cataforesis para productos de exterior, cambio de materiales, medidas, detalles o accesorios. Capacidad para fabricar un producto único que se ajuste a cualquier necesidad.

FRA Existe la posibilidad de cambiar características a un producto para que su uso sea viable en cualquier entorno: aplicar tratamientos de cataforesis para productos de exterior, cambio de materiales, medidas, detalles o accesorios. Capacidad para fabricar un producto único que se ajuste a cualquier necesidad.

CONTACTO

Contacta con nuestro equipo para más detalles. ■ Contact our team for more details ■ Contact-ez nous plus de détails.

AÑADIR SU **LOGOTIPO**
ADD A **LOGOTYPE**
AJOUTER VOTRE **LOGO**

CAMBIO DE **MATERIALES**
MATERIALS CHANGE
CHANGEMENT DES **MATERIELS**

VINILO / SERIGRAFÍA
VYNIL / SERIGRAPHY
VINILE / SERIGRAPHIE

ACCESORIOS
ACCESORIES
ACCESOIRES

MEDIDA NO STANDARD
NO STANDARD **SIZE**
MEASURES HORS STANDARD

CAMBIO DE **DETALLES**
DETAILS CHANGE
CHANGEMENT DES **DÉTAILS**



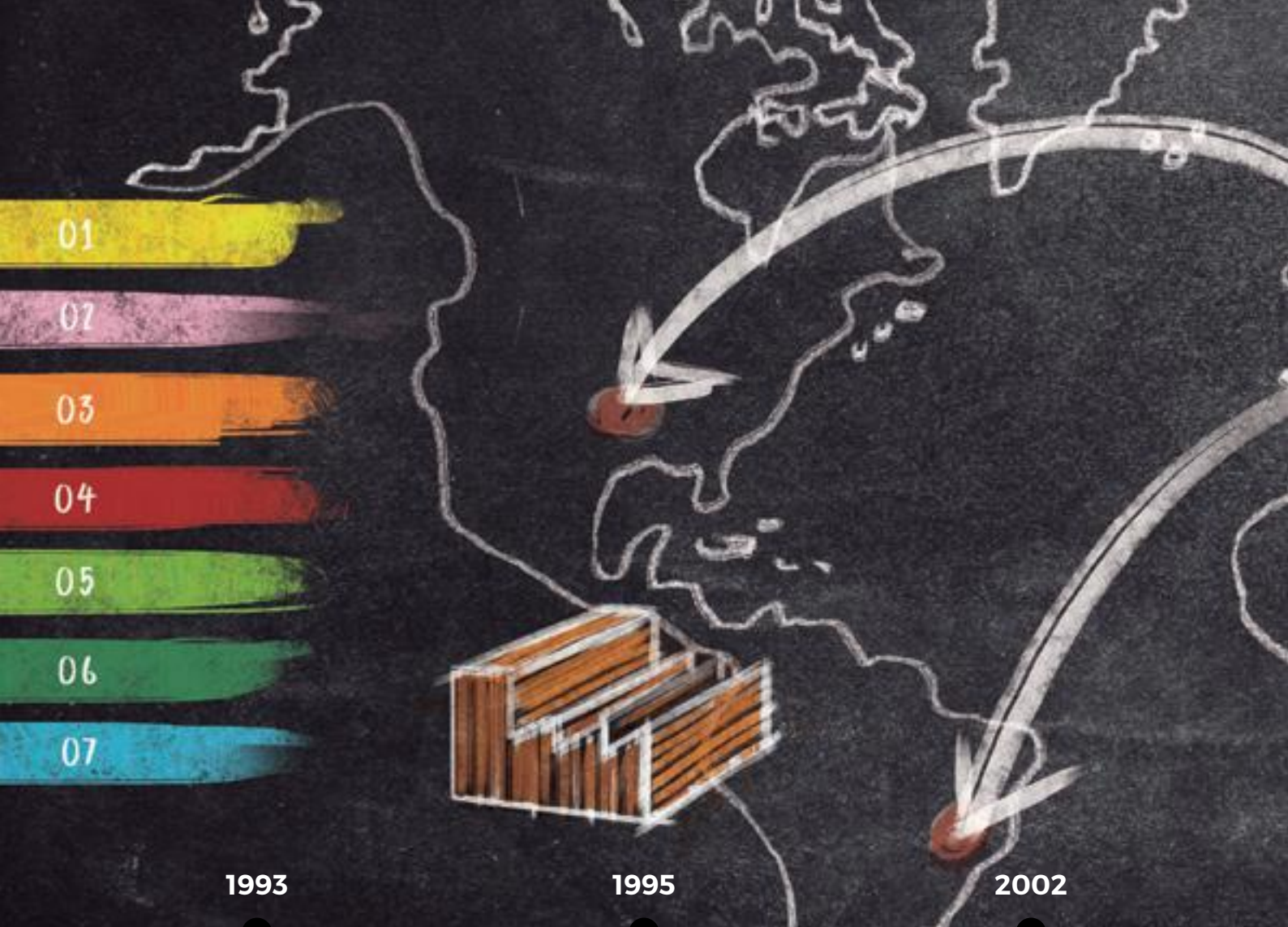

1993

1995

2002

ESP División de los productos de Planning Sisplamo que aún se mantiene: Visualplan, Escolplan, Informplan, Expoplan, Rotulplan, Modulplan y Proyectplan.

ENG Creation of the different product divisions which are still maintained: Visualplan, Escolplan, Informplan, Expoplan, Rotulplan, Modulplan and Proyectplan.

FRA Création des divisions de produits Planning Sisplamo qui se maintiennent encore à ce jour : Visualplan, Escolplan, Informplan, Expoplan, Rotulplan, Modulplan y Proyectplan.

ESP Primer gran traslado a una fábrica de 1500 m², para aumentar producción y personal. Des de 1995, nos hemos trasladado dos veces más: el 2005 y 2015.

ENG First big move to a 1500 m² factory to increase production and personnel. Since 1995, we have moved twice more: 2005 and 2015.

FRA Premier grand déménagement dans une usine de 1500 m² afin d'augmenter la production et le personnel. Depuis 1995 nous avons déménagé deux fois de plus en 2005 et 2015.

ESP La marca Planning Sisplamo crece. Creación del Departamento Comercial, tanto a nivel nacional como internacional.

ENG The Planning Sisplamo brand grows. Creation of the Commercial Department, both nationally and internationally.

FRA La marque Planning Sisplamo croît. Création du département commercial, tant au niveau national qu'international.



2007

2010

2017

ESP Celebración del 40 aniversario de la empresa. La empresa sigue creciendo sin temor a mercados emergentes.

ENG PS celebrates its 40th anniversary. The company continues to grow without fear of emerging markets.

FRA Célébration du 40ème anniversaire de l'entreprise. La société continue de grandir sans crainte aux marchés émergents.

ESP Tras la creación del Departamento de Diseño el 2008, se presenta la marca de diseño MADE DESIGN BARCELONA, con muebles creados por diseñadores de primer nivel.

ENG After the creation of the Design Department in 2008, the design brand MADE DESIGN BARCELONA is launched, with accessories created by leading designers.

FRA Depuis la création du département design en 2008, nous présentons la marque MADE DESIGN BARCELONA, avec des meubles créés par des designers de premier niveau.

ESP 50 aniversario de Planning Sisplamo. La empresa sigue evolucionando, creciendo y expandiéndose gracias a la confianza de nuestros clientes, a los que estamos eternamente agradecidos.

ENG 50th Anniversary of Planning Sisplamo. The company continues to evolve, grow and expand thanks to the trust of our customers, to whom we are eternally grateful.

FRA 50ème anniversaire de Planning Sisplamo. L'entreprise continue son évolution, en grandissant et en s'élargissant grâce à la confiance de nos clients, pour lesquels nous serons éternellement reconnaissant.

50 YEARS

1967 - 2017

GRACIAS - THANK YOU - MERCI

ESP A vosotros, clientes. Gracias por estos 50 años de confianza, de crecimiento, de investigación y de evolución. Llegamos a los 50 en buena forma, con experiencia y ganas de seguir trabajando. Estamos orgullosos de nuestra historia y recorrido y nos hace mucha ilusión compartirla con vosotros. ¡Gracias!

ENG To you, our partners. Thank you for these 50 years of trust and support allowing us to grow, develop and evolve. We arrived at our 50th anniversary in good shape, with the experience and desire to continue developing and going forward. We are proud of our history and the path we have followed and we are very excited to share it with you. Thank you!

FRA A vous, chers clients. Merci, pour ces 50 ans de confiance, de croissance, d'investigation et d'évolution. Nous arrivons aux 50 en forme, avec de l'expérience et l'envie de continuer. Nous sommes fière de notre histoire et du chemin parcouru, et nous sommes heureux de pouvoir le partager avec vous. Merci!

