

2025 GENERAL CATALOGUE

The BRAND of RESPONSIBLE BRANDS

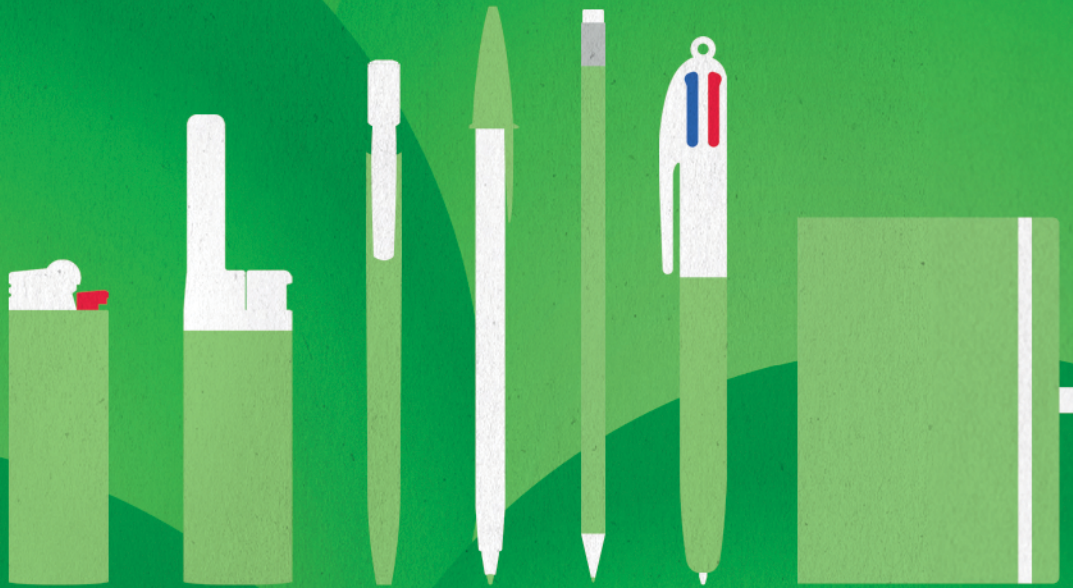

 **BIC** graphic

THE BRAND OF
RESPONSIBLE BRANDS



THINK BIC

WHY WE DO WHAT WE DO

Our mission is simple: to create lasting, sustainable solutions that help businesses thrive while protecting the planet. Since 1995, at BIC Graphic we have consistently innovated to offer creative, sustainable, and long-lasting solutions to personalise iconic BIC products. We've been driven by a commitment to responsible practices and believe in the power of thoughtful innovation, where every product is a step towards minimising our carbon footprint. From using energy coming from renewable sources to working with local suppliers who share our values, we ensure that sustainability is not just a goal, but a way of doing business.

That's why you'll find our exciting new products made in Europe, including the BIC® EZ Reach™, the BIC® Cristal® Expression that writes up to 3 km, the BIC® Kids Evolution® Colouring Set and the BIC® Media Clic Biobased, available in trendy Pastel colours. These products reflect our ongoing commitment to quality, innovation and responsibility.

BIC Graphic. The Brand of Responsible Brands.

FR

POURQUOI FAISONS-NOUS CE QUE NOUS FAISONS

Notre mission est simple : créer des solutions durables et responsables qui aident les entreprises à prospérer tout en prenant soin de la planète. Depuis 1995, chez BIC Graphic, nous avons constamment pour offrir des solutions créatives, durables et pérennes afin de personnaliser les produits emblématiques de BIC. Animés par un engagement envers des pratiques responsables, nous croyons au pouvoir d'une innovation réfléchie, où chaque produit représente une avancée vers la réduction de notre empreinte carbone. De l'utilisation d'énergie provenant de sources renouvelables à notre collaboration avec des fournisseurs locaux qui partagent nos valeurs, nous veillons à ce que la durabilité ne soit pas seulement un objectif, mais une façon de faire des affaires.

C'est pourquoi, dans cette édition, vous découvrirez nos nouvelles créations fabriquées en Europe, notamment le BIC® EZ Reach™, le BIC® Cristal® Expression, qui écrit jusqu'à 3 km, le BIC® Kids Evolution® Colouring Set et le BIC® Media Clic Biobased, disponible dans des couleurs Pastel tendances. Ces produits reflètent notre engagement continu envers la qualité, l'innovation et la responsabilité.

BIC Graphic. The Brand of Responsible Brands.

DE

WARUM TUN WIR, WAS WIR TUN

Unsere Mission ist einfach: nachhaltige Lösungen zu schaffen, die Unternehmen dabei unterstützen, erfolgreich zu sein, während wir gleichzeitig für unseren Planeten sorgen. Seit 1995 haben wir bei BIC Graphic kontinuierlich Innovationen entwickelt, um kreative, nachhaltige und langlebige Lösungen für die Personalisierung der kultigen BIC-Produkte anzubieten. Unser Handeln wird von einem Engagement für verantwortungsvolle Praktiken geprägt, und wir glauben an die Kraft durchdachter Innovationen, bei denen jedes Produkt einen Schritt zur Minimierung unseres Kohlenstoff-Fußabdrucks darstellt. Von der Nutzung von Strom aus erneuerbaren Energien bis hin zur Zusammenarbeit mit lokalen Lieferanten, die unsere Werte teilen, stellen wir sicher, dass Nachhaltigkeit nicht nur ein Ziel, sondern eine Arbeitsweise ist.

Deshalb finden Sie in dieser Ausgabe unsere spannenden neuen Produkte, die in Europa gefertigt werden, wie den BIC® EZ Reach™, den BIC® Cristal® Expression, der bis zu 3 km schreibt, das BIC® Kids Evolution® Colouring Set und den BIC® Media Clic Biobased, erhältlich in angesagten Pastel-Farben. Diese Produkte spiegeln unser kontinuierliches Engagement für Qualität, Innovation und Verantwortung wider.

BIC Graphic. The Brand of Responsible Brands.

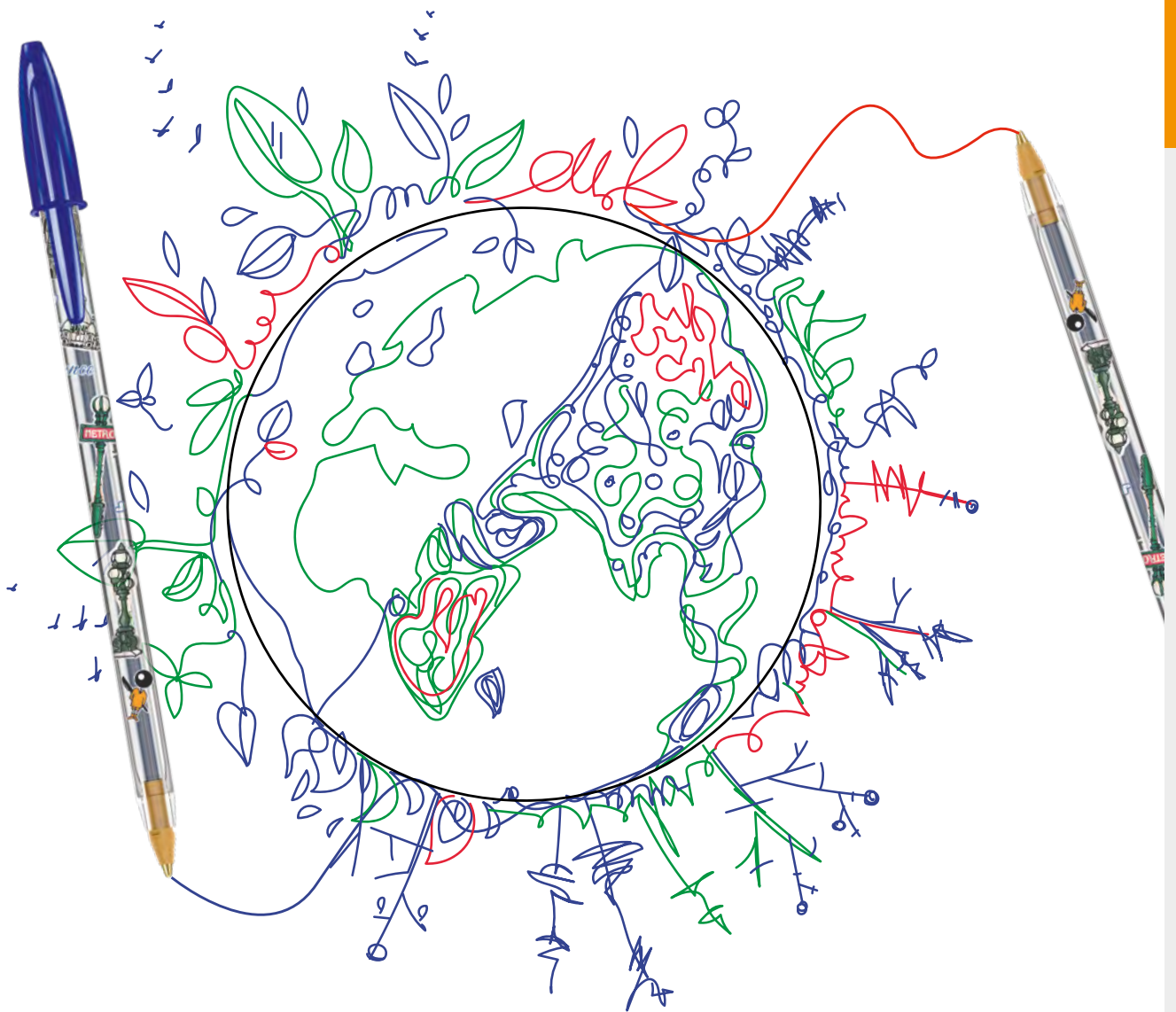

IT
PERCHÉ FACCIAMO QUELLO CHE FACCIAMO

La nostra missione è semplice: creare soluzioni durature e sostenibili che aiutino le aziende a prosperare, prendendosi cura del pianeta. Dal 1995 presso BIC Graphic, abbiamo costantemente per offrire soluzioni creative, sostenibili e durature per personalizzare i prodotti iconici BIC. Guidati da un impegno verso pratiche responsabili, crediamo nel potere dell'innovazione consapevole, in cui ogni prodotto rappresenta un passo avanti verso la riduzione della nostra impronta di carbonio. Dall'uso di energia proveniente da fonti rinnovabili alla collaborazione con fornitori locali che condividono i nostri valori, ci assicuriamo che la sostenibilità non sia solo un obiettivo, ma un modo di fare impresa.

Ecco perché, in questa edizione, troverete le nostre nuove proposte realizzate in Europa, tra cui il BIC® EZ Reach™, il BIC® Cristal® Expression, che scrive fino a 3 KM, il BIC® Kids Evolution® Colouring Set e il BIC® Media Clic Biobased, disponibile in colori pastel alla moda. Questi prodotti riflettono il nostro costante impegno verso la qualità, l'innovazione e la responsabilità.

BIC Graphic. The Brand of Responsible Brands.

ES
¿POR QUÉ HACEMOS LO QUE HACEMOS?

Nuestra misión es simple: crear soluciones duraderas y sostenibles que ayuden a las empresas a prosperar mientras cuidamos del planeta. Desde 1995, en BIC Graphic, hemos innovado constantemente para ofrecer soluciones creativas, sostenibles y duraderas para personalizar los productos icónicos de BIC. Impulsados por un compromiso con prácticas responsables, creemos en el poder de la innovación consciente, donde cada producto es un paso hacia la minimización de nuestra huella de carbono. Desde el uso de energía proveniente de fuentes renovables hasta trabajar con proveedores locales que comparten nuestros valores, nos aseguramos de que la sostenibilidad no sea solo un objetivo, sino una forma de hacer negocios.

Por eso, en esta edición, encontrarás nuestros emocionantes nuevos lanzamientos fabricados en Europa, como el BIC® EZ Reach™, el BIC® Cristal® Expression, que escribe hasta 3 KM, el BIC® Kids Evolution® Colouring Set e el BIC® Media Clic Biobased, disponible en colores pastel de tendencia. Estos productos reflejan nuestro continuo compromiso con la calidad, la innovación y la responsabilidad.

BIC Graphic. The Brand of Responsible Brands.

BIC GRAPHIC

3

The Brand of Responsible Brands	2	Sustainable Products	20
Think BIC	4	75th anniversary of BIC® Cristal®	22
Contents	6	Novelties	24
Exploring BIC Graphic	8	BIC® Collection Boxes	32
Sustainability	12	Printing Techniques	34
Made in Europe	18	Full Colour britePix™ Digital Range	36

BIC® WRITING INSTRUMENTS

38

BALLPENS

BIC® Cristal® Expression	40
BIC® Cristal® Re'New™	44
BIC® Style	48
BIC® Round Stic®	52
BIC® Round Stic® BGuard™ antibacterial	54
BIC® Round Stic® Ecolutions®	55
BIC® M10® Clic	58
BIC® Media Clic	62
BIC® Media Clic Ecolutions®	63
BIC® Media Clic Grip	65
BIC® Media Clic Grip Ecolutions®	66
BIC® Media Clic BGuard™ antibacterial	72
BIC® Media Clic BGuard™ antimicrobial Ecolutions®	74
BIC® Media Clic Biobased Ecolutions®	76
BIC® Media Clic Biobased BGuard™ antibacterial	80
BIC® Media Clic Shine	82
BIC® Media Clic Glacé	84
BIC® Clic Stic	86
BIC® Clic Stic Ecolutions®	87
BIC® Clic Stic Stylus	90
BIC® Clic Stic Stylus Ecolutions®	90
BIC® Super Clip	96
BIC® Super Clip Ecolutions®	97
BIC® Super Clip Advance	100
BIC® Super Clip Glacé	104
BIC® Super Clip Glacé Advance	104
BIC® Super Clip Soft	106
BIC® Super Clip Soft Advance	106
BIC® Super Clip Origin	108
BIC® Wide Body™	112
BIC® Wide Body™ Ecolutions®	113
BIC® 4 Colours®	120
BIC® 4 Colours® Rainbow Decor	122
BIC® 4 Colours® Bicolor	124
BIC® 4 Colours® Gradient	126
BIC® 4 Colours® Pastel	128
BIC® 4 Colours® Fashion	130

BIC® 4 Colours® Sun	132
BIC® 4 Colours® Fine	134
BIC® 4 Colours® Fluo	136
BIC® 4 Colours® Glacé	138
BIC® 4 Colours® Shine	140
BIC® 4 Colours® Soft	142
BIC® 4 Colours® Wood Style	144
BIC® 4 Colours® Flags Collection	146
BIC® 4 Colours® 3+1 ^{HB}	148

METALLIC PENS

BIC® Metal Pro	150
----------------	-----

ROLLERS AND GELS

BIC® Grip Roller	156
BIC® XS Finestyle	158
BIC® Intensity® Gel Clic	160

HIGHLIGHTERS AND MARKERS

BIC® Brite Liner® Grip	164
BIC® Velleda® White Board Marker Fine	166
BIC® Velleda® White Board Marker Grip	167
BIC® Mark-It Permanent Marker	168
BIC® Permanent Marker Ecolutions®	169

MECHANICAL PENCILS

BIC® Matic®	172
BIC® Matic® Ecolutions®	172
BIC® Media Clic Mechanical pencil	174
BIC® Media Clic Grip Mechanical pencil	175
BIC® Media Clic Grip Mechanical pencil Ecolutions®	175

PENCILS

BIC® Evolution® Ecolutions®	180
BIC® Kids Evolution® Colouring Set	184
Sprout™ Graphite pencil	186

OTHER WRITING INSTRUMENTS

188

PLASTIC PENS

Basic Pen	190
Click Pen	192
Striped Grip Pen	194

STYLUS PENS

Sleek Stylus Pen	196
------------------	-----

NOTEBOOKS

198

ROCKETBOOK®

Rocketbook® Core Executive A5	202
Rocketbook® Fusion Executive A5	204
Rocketbook® Core Mini A6	206

MOLESKINE®

Moleskine® Classic Notebooks	210
Moleskine® Cahier Journals	214

BIC®/DJEET® LIGHTERS AND BIC® CASES

216

LIGHTERS

BIC® J25 Lighter	222
BIC® J23 Lighter	226
BIC® J26 Lighter	230
BIC® J38 Lighter	234

OTHER PRODUCTS

BIC® EZ Reach™	244
BIC® Pocket Ashtray	248

DJEET® LIGHTERS

DJEET® D1 Lighter	250
-------------------	-----

LIGHTER CASES

BIC® Styl'it Luxury Case	238
BIC® Aluminium Flat Case	240
BIC® Clip Case	241
BIC® 3D Case	242

BIC® PACKAGING

260

BIC® Packaging Ecolutions®	262
BIC® Packaging	264

GENERAL INFORMATION

268

Make it simple!	270	Product index	279
Symbols and abbreviations	274	Colour table	280
General information	278		

OUR STORY

With over 80 years of brand heritage, we at BIC Graphic stand out for our commitment to innovation, affordability and excellence. Rooted in our core values of customer service, social responsibility and sustainable development, we proudly lead the promotional marketing sector in Europe, the Middle East and Africa. Our creative, sustainable solutions help elevate our customers' brands.

FR

NOTRE HISTOIRE

Nous sommes la division du Groupe BIC qui personnalise les produits BIC®, basée à Tarragone, en Espagne, depuis 1995.

Avec plus de 80 ans d'héritage de marque, nous, chez BIC Graphic, nous nous distinguons par notre engagement envers l'innovation, l'accessibilité et l'excellence. Fondés sur nos valeurs fondamentales de service client, de responsabilité sociale et de développement durable, nous sommes fiers de diriger le secteur du marketing promotionnel en Europe, au Moyen-Orient et en Afrique. Nos solutions créatives et durables aident à valoriser les marques de nos clients.

IT

LA NOSTRA STORIA

Siamo la divisione del Gruppo BIC che personalizza i prodotti BIC®, con sede a Tarragona, Spagna, dal 1995.

Con oltre 80 anni di eredità del marchio, noi di BIC Graphic ci distinguiamo per il nostro impegno verso l'innovazione, l'accessibilità e l'eccellenza. Radicati nei nostri valori fondamentali di servizio clienti, responsabilità sociale e sviluppo sostenibile, guidiamo con orgoglio il settore del marketing promozionale in Europa, Medio Oriente e Africa. Le nostre soluzioni creative e sostenibili aiutano a elevare i marchi dei nostri clienti.

DE

UNSERE GESCHICHTE

Wir sind der Geschäftsbereich der BIC-Gruppe, der BIC®-Produkte personalisiert und seit 1995 in Tarragona, Spanien ansässig ist.

Mit über 80 Jahren Markengeschichte zeichnen wir uns bei BIC Graphic durch unser Engagement für Innovation, Erschwinglichkeit und Exzellenz aus. Basierend auf unseren Grundwerten Kundenservice, soziale Verantwortung und nachhaltige Entwicklung führen wir stolz den Werbemarkt in Europa, dem Nahen Osten und Afrika an. Unsere kreativen, nachhaltigen Lösungen helfen dabei, die Marken unserer Kunden zu stärken.

ES

NUESTRA HISTORIA

Somos la división del Grupo BIC que personaliza los productos BIC®, con sede en Tarragona, España, desde 1995.

Con más de 80 años de herencia de marca, en BIC Graphic nos destacamos por nuestro compromiso con la innovación, la accesibilidad y la excelencia. Basados en nuestros valores fundamentales de servicio al cliente, responsabilidad social y desarrollo sostenible, lideramos con orgullo el sector del marketing promocional en Europa, Oriente Medio y África. Nuestras soluciones creativas y sostenibles ayudan a elevar las marcas de nuestros clientes.

We are the division of the BIC Group that personalises BIC® products, based in Tarragona, Spain since 1995.

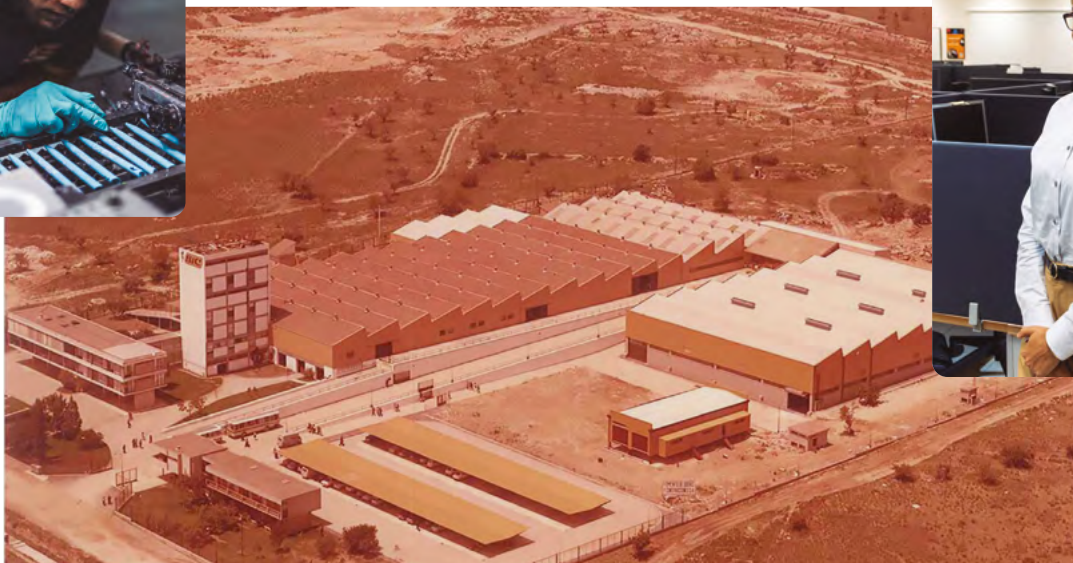

OUR PILLARS

FR NOS PILIERS

Iconique et innovant. Animés par une passion pour l'innovation, nous introduisons des techniques de personnalisation de pointe, lançons des produits durables de meilleure qualité et ajoutons des finitions tendance à nos articles les plus emblématiques. En tant que marque de renommée mondiale, BIC Graphic reste un symbole de créativité tournée vers l'avenir.

Responsable. BIC Graphic est une référence de confiance pour les normes les plus élevées en matière de qualité et de sécurité, fermement engagée envers la responsabilité sociale, environnementale et éthique.

Proche de vous. Nous avons toujours été à vos côtés lors des moments importants de votre vie, comprenant vos besoins comme s'ils étaient les nôtres. C'est pourquoi nous offrons une parfaite personnalisation grâce à des outils numériques, facilitant la création de ce que vous imaginez. Notre engagement en faveur de la production locale nous rapproche encore plus de vous tout en contribuant à réduire notre empreinte carbone.

IT I NOSTRI PILASTRI

Iconico e innovativo. Guidati da una passione per l'innovazione, introduciamo tecniche di personalizzazione all'avanguardia, lanciamo prodotti sostenibili di qualità superiore e aggiungiamo finiture di tendenza ai nostri articoli più iconici. Come marchio di fama mondiale, BIC Graphic rimane un simbolo di creatività orientata al futuro.

Responsabile. BIC Graphic è un punto di riferimento affidabile per i più alti standard di qualità e sicurezza, con un impegno fermo verso la responsabilità sociale, ambientale ed etica.

Vicino a te. Siamo sempre stati al tuo fianco nei momenti importanti della tua vita, comprendendo i tuoi bisogni come fossero i nostri. Per questo offriamo una personalizzazione semplice e intuitiva con strumenti digitali, rendendo facile creare ciò che immagini. Il nostro impegno per la produzione locale ci avvicina ulteriormente a te, contribuendo al contempo a ridurre la nostra impronta di carbonio.

DE UNSERE GRUNDSÄTZE

Legendär und innovativ. Angetrieben von einer Leidenschaft für Innovation, führen wir modernste Personalisierungstechniken ein, bringen nachhaltigere, hochwertigere Produkte auf den Markt und fügen unseren legendären Artikeln trendige Veredelungen hinzu. Als weltweit bekannte Marke bleibt BIC Graphic ein Symbol für zukunftsweisende Kreativität.

Zuverlässig. BIC Graphic ist ein vertrauenswürdiger Maßstab für höchste Standards in Qualität und Sicherheit und fest verpflichtet zu sozialer, ökologischer und ethischer Verantwortung.

An Ihrer Seite. Wir sind immer gewesen in den wichtigen Momenten des Lebens an Ihrer Seite und verstehen Ihre Bedürfnisse, als wären es unsere eigenen. Deshalb bieten wir nahtlose Personalisierung mit modernster Technik, die es einfach macht, genau das zu gestalten, was Sie sich vorstellen. Unser Engagement für lokale Produktion bringt uns noch näher zu Ihnen und trägt gleichzeitig dazu bei, unseren CO2-Fußabdruck zu verringern.

ES NUESTROS PILARES

Iconicos e innovadores. Impulsados por una pasión por la innovación, introducimos técnicas de personalización de vanguardia, lanzamos productos sostenibles de mayor calidad y añadimos acabados vanguardistas a nuestros artículos más icónicos. Como una marca reconocida mundialmente, BIC Graphic sigue siendo un símbolo de creatividad con visión de futuro.

Confiables. BIC Graphic es un referente confiable de los más altos estándares de calidad y seguridad, firmemente comprometido con la responsabilidad social, ambiental y ética.

Cerca de ti. Siempre hemos estado a tu lado en los momentos importantes de la vida, entendiendo tus necesidades como si fueran nuestras. Por eso ofrecemos una personalización fluida con herramientas digitales, facilitando la creación de lo que imaginas. Nuestro compromiso con la producción local nos acerca aún más a ti mientras ayudamos a reducir nuestra huella de carbono.

Iconic and innovative

Driven by a passion for innovation, we introduce cutting-edge customisation techniques, launch higher-quality, sustainable products, and add trendsetting finishes to our most iconic items. As a world-renowned brand, BIC Graphic remains a symbol of forward-thinking creativity.

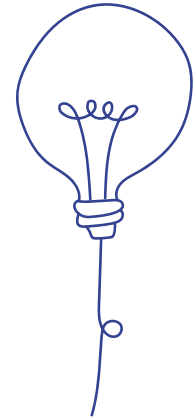

✓ Trusted

BIC Graphic is a trusted benchmark for the highest standards in quality and safety, firmly committed to social, environmental and ethical responsibility.

Close to you

We've always been by your side through life's important moments, understanding your needs as if they were our own. That's why we offer seamless customisation with digital tools, making it easy to create exactly what you envision. Our commitment to local production brings us even closer to you while helping to reduce our carbon footprint.



The BRAND of RESPONSIBLE BRANDS

1

We were
born A
RESPONSIBLE
BRAND

Our primary objective is to manufacture and customise the most useful and longest-lasting products on the market, thereby conserving natural resources.



FR

1. NOUS SOMMES NÉS POUR ÊTRE UNE MARQUE RESPONSABLE

Notre premier objectif est de fabriquer et de personnaliser les produits les plus utiles et les plus durables du marché, de sorte à préserver les ressources naturelles.

DE

1. WIR SIND ALS VERANTWORTUNGSBEWUSSTE MARKE ENTSTANDEN

Unser Hauptziel ist es, die nützlichsten und langlebigsten Produkte auf dem Markt herzustellen und individuell zu gestalten und dabei natürliche Ressourcen zu schonen.

IT

1. SIAMO NATI COME MARCHIO RESPONSABILE

Il nostro obiettivo principale è quello di produrre e personalizzare i prodotti più utili e duraturi presenti sul mercato, preservando allo stesso tempo le risorse naturali.

ES

1. NACEMOS COMO UNA MARCA RESPONSABLE

Nuestro principal objetivo es fabricar y personalizar los productos más útiles y duraderos del mercado, conservando los recursos naturales.

2

iNNOVATION is in our NATURE

Rethink everything.
There is still so much to be discovered.
The invented can be reinvented.
That's our approach.



FR

2. L'INNOVATION EST DANS NOTRE NATURE

Tout repenser. Il reste encore tant de choses à découvrir.
Ce qui a été inventé peut être réinventé. C'est notre approche.

IT

L'INNOVAZIONE FA PARTE DELLA NOSTRA NATURA

Ripensare tutto. C'è ancora tanto da scoprire.
L'inventato può essere reinventato. È questo il nostro approccio.

DE

2. INNOVATION LIEGT IN UNSERER NATUR

Alles neu denken. Es gibt noch so viel zu entdecken.
Erfundenes kann neu erfunden werden. Das ist unser Konzept.

ES

2. LA INNOVACIÓN ESTÁ EN NUESTRA NATURALEZA

Replantarse todo. Aún queda mucho por descubrir.
Lo inventado puede reinventarse. Ese es nuestro enfoque.

3

WE WORK to Create SOLUTIONS WITHOUT CREATING problems

Working to provide solutions for companies, while minimising our environmental footprint. We do this using only renewable energy. Moreover, we prioritise the use of biobased and recycled materials in the manufacturing process.



FR

3. NOUS TRAVAILLONS POUR CRÉER DES SOLUTIONS SANS CRÉER DE PROBLÈMES

Nous travaillons pour apporter des solutions aux entreprises, tout en minimisant notre empreinte environnementale. À cette fin, nous utilisons exclusivement des énergies renouvelables. En outre, nous privilégions l'utilisation de matériaux biosourcés et recyclés dans le processus de fabrication.

(IT)

3. LAVORIAMO PER CREARE SOLUZIONI SENZA CREARE PROBLEMI

Lavorare per fornire soluzioni alle aziende, riducendo al minimo il nostro impatto ambientale. A tal fine, utilizziamo esclusivamente energia rinnovabile. Inoltre, diamo priorità all'uso di materiali biobased e riciclati nel processo di produzione.

DE

3. WIR WOLLEN LÖSUNGEN SCHAFFEN, OHNE PROBLEME ZU VERURSACHEN

Wir suchen nach Lösungen für Unternehmen und minimieren gleichzeitig unseren ökologischen Fußabdruck. Zu diesem Zweck verwenden wir ausschließlich erneuerbare Energien. Darüber hinaus verwenden wir bei der Herstellung vorrangig biobasierte und recycelte Materialien.

ES

3. TRABAJAMOS PARA CREAR SOLUCIONES SIN CREAR PROBLEMAS

Trabajamos para ofrecer soluciones a las empresas, minimizando al mismo tiempo nuestra huella medioambiental. Para ello utilizamos exclusivamente energías renovables. Además, damos prioridad al uso de materiales biológicos y reciclados en el proceso de fabricación.

4

WE ARE PEOPLE WORKING FOR PEOPLE

The way we do business is just as important as the outcome of our efforts. We manufacture and customise in Europe, maintaining the highest standards of health and safety while promoting equality, diversity and inclusion in the workplace. We also believe that education is a catalyst to improve people's lives. That's why we promote education around the world through the BIC Corporate Foundation.



FR

4. NOUS SOMMES DES PERSONNES QUI TRAVAILLENT AU SERVICE D'AUTRES PERSONNES

Notre manière de travailler est tout aussi importante que le résultat de nos efforts. Nous fabriquons et personnalisons nos produits en Europe, en respectant les normes les plus strictes en matière de santé et de sécurité, et en œuvrant en faveur de l'égalité, de la diversité et de l'inclusion sur le lieu de travail. Nous croyons également que l'éducation est un catalyseur pour améliorer la vie des personnes. C'est pourquoi nous nous efforçons de promouvoir l'éducation dans le monde, par le biais de la Fondation d'entreprise BIC.

IT

4. SIAMO PERSONE CHE LAVORANO PER LE PERSONE

Il modo in cui conduciamo la nostra attività è importante quanto il risultato del nostro impegno. Produciamo e personalizziamo in Europa, mantenendo i più elevati standard di salute e sicurezza, promuovendo al contempo l'uguaglianza, la diversità e l'inclusione sul posto di lavoro. Crediamo anche che l'istruzione sia un catalizzatore per migliorare la vita delle persone. Ecco perché promuoviamo l'istruzione in tutto il mondo attraverso la BIC Corporate Foundation.

DE

4. WIR SIND MENSCHEN, DIE FÜR MENSCHEN ARBEITEN

Die Art und Weise, wie wir tätig sind, ist genauso wichtig wie das Ergebnis unserer Bemühungen. Wir fertigen und personalisieren unsere Produkte in Europa, unter Einhaltung höchster Gesundheits- und Sicherheitsstandards und fördern Gleichstellung, Vielfalt und Integration am Arbeitsplatz. Wir sind auch der Ansicht, dass Bildung ein Schlüsselfaktor für die Verbesserung der Lebensqualität von Menschen ist. Deshalb fördern wir weltweit Bildung durch die BIC Corporate Foundation.

ES

4. SOMOS PERSONAS QUE TRABAJAN PARA PERSONAS

La forma en que hacemos negocios es tan importante como el resultado de nuestros esfuerzos. Fabricamos y personalizamos en Europa, manteniendo los más altos niveles de salud y seguridad a la vez que promovemos la igualdad, la diversidad y la inclusión en el lugar de trabajo. También creemos que la educación es un catalizador para mejorar la vida de las personas. Por eso promovemos la educación en todo el mundo a través de la Fundación Corporativa BIC.

5 A BETTER US. BETTER CLOSE BY

Our company manufactures and customises products in Europe. With our own factories, we ensure **sustainable work processes of the highest quality**. What's more, by remaining close to our customers and suppliers, we are able to reduce **delivery times** and significantly minimise our carbon footprint. That's because our products don't travel halfway around the world to reach their destination.



FR

5. MIEUX FAIRE. EN ÉTANT PLUS PROCHES

Nous fabriquons et personnalisons nos produits en Europe. Nous disposons de nos propres usines, ce qui nous permet de garantir des processus de travail durables et de la plus haute qualité. De plus, en restant proches de nos clients et de nous fournisseur, nous sommes en mesure de réduire les délais de livraison et de minimiser notre empreinte carbone de manière significative. Parce que nos produits ne parcourent pas la moitié du monde pour atteindre leur destination.

IT

5. MEGLIO LA PROSSIMITÀ. PER ESSERE MIGLIORI

La nostra azienda produce e personalizza prodotti in Europa. Attraverso stabilimenti di produzione propri garantiamo processi di lavorazione sostenibili di massima qualità. Inoltre, grazie alla prossimità con i nostri fornitori, siamo in grado di ridurre i tempi di consegna e abbattere significativamente la nostra impronta di carbonio perché i nostri prodotti non devono attraversare il mondo per giungere a destinazione.

DE

5. EIN BESSERES WIR. NÄHER IST BESSER

Unser Unternehmen fertigt Produkte maßgeschneidert in Europa. Mit unseren eigenen Fabriken gewährleisten wir nachhaltige Arbeitsprozesse von höchster Qualität. Darüber hinaus verringern wir durch die Nähe zu unseren Lieferanten die Lieferzeiten und minimieren unseren Co2-Fußabdruck erheblich. Das liegt daran, dass unsere Produkte nicht um die ganze Welt reisen, um an ihren Bestimmungsort zu gelangen.

ES

5. UN NOSOTROS ES MEJOR. MÁS CERCA ES MEJOR

Nuestra empresa fabrica y personaliza productos en Europa. Con nuestras propias fábricas, garantizamos procesos de trabajo sostenibles y de la máxima calidad. Además, al permanecer cerca de nuestros clientes y proveedores, podemos reducir los plazos de entrega y minimizar significativamente nuestra huella de carbono. Eso se debe a que nuestros productos no recorren medio mundo para llegar a su destino.

6

WE ARE RESPONSIBLE FROM BEGINNING TO END

It is not enough for us to be responsible in manufacturing. We also want to work with local suppliers who share our respect for people and the planet and are willing to assume our commitments. In addition, we assume a responsibility to our clients; we understand that we have a commitment to people, the environment, quality and service. These are essential elements of the way we do business.

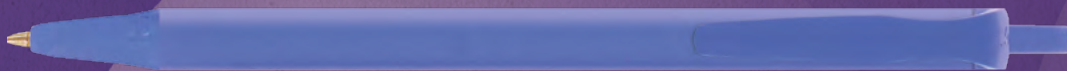

FR

6. NOUS SOMMES RESPONSABLES DU DÉBUT À LA FIN

Pour nous, la responsabilité ne se limite pas à la fabrication. Nous voulons également travailler avec des fournisseurs locaux qui partagent notre respect des personnes et de la planète et qui sont prêts à assumer nos engagements. Nous assumons également une responsabilité envers nos clients, en étant conscients que notre expérience signifie notre engagement envers les personnes, l'environnement, la qualité et le service. Ce sont des aspects essentiels de notre façon de mener nos activités.

IT

6. RESPONSABILI DALL'INIZIO ALLA FINE

Per noi non è sufficiente essere responsabili nel settore manifatturiero. Vogliamo anche lavorare con fornitori locali che condividono il nostro rispetto per le persone e il pianeta, e siamo pronti a farci carico dei nostri impegni. Ci assumiamo anche la responsabilità nei confronti dei nostri clienti, sapendo che la nostra esperienza significa che abbiamo assunto un impegno nei confronti delle persone, dell'ambiente, della qualità e del servizio. Questi fattori sono essenziali nel nostro modo di lavorare.

DE

6. WIR SIND VERANTWORTUNGSBEWUSST VON ANFANG BIS ENDE

Nur in der Produktion verantwortungsbewusst zu sein, genügt uns nicht. Wir wollen auch mit lokalen Lieferanten zusammenarbeiten, die unsere Achtung vor Menschen und dem Planeten teilen und bereit sind, unser Engagement zu übernehmen. Wir übernehmen auch Verantwortung für unsere Kunden, da wir uns aufgrund unserer Erfahrung den Menschen, der Umwelt, der Qualität und dem Service verpflichtet fühlen. Diese Faktoren sind wesentliche Bestandteile unserer Geschäftstätigkeit.

ES

6. SOMOS RESPONSABLES DE PRINCIPIO A FIN

No nos basta con ser responsables en la fabricación. También queremos trabajar con proveedores locales que compartan nuestro respeto por las personas y el planeta y estén dispuestos a asumir nuestros compromisos. También asumimos una responsabilidad con nuestros clientes; entendemos que tenemos un compromiso con las personas, el medio ambiente, la calidad y el servicio. Estos son elementos esenciales de nuestra forma de hacer negocios.

MADE IN EUROPE: CLOSE TO YOU

“Made in Europe” is more than a label. Since 1950, it has been central to BIC’s promise of quality and sustainability. From our origins in France to personalised creations in Tarragona, Spain, we design and produce select writing instruments and lighters locally, keeping production close to you.

This approach minimises shipping distances and reduces our environmental footprint by sourcing materials from European suppliers and producing on demand. Our ISO 14001 and 9001-certified facilities uphold the highest standards of quality, sustainability, and employee safety.

Being close to our customers and suppliers ensures faster production, better supply chain control, and fewer delays. “Made in Europe” isn’t just a location—it’s our commitment to responsibility, connection, and quality.

FR FABRIQUÉ EN EUROPE : PROCHE DE VOUS

„Fabriqué en Europe” est bien plus qu’un label. Depuis 1950, il est au cœur de l’engagement de BIC pour la qualité et la durabilité. De nos origines en France à nos créations personnalisées à Tarragone, en Espagne, nous concevons et produisons localement des instruments d’écriture et des briquets sélectionnés, en restant proches de vous.

Cette approche réduit les distances de transport et notre empreinte écologique grâce à l’approvisionnement en matériaux auprès de fournisseurs européens et à une production à la demande. Nos installations certifiées ISO 14001 et 9001 respectent les normes les plus élevées de qualité, de durabilité et de sécurité des employés.

Être proches de nos clients et de nos fournisseurs permet une production plus rapide, un meilleur contrôle de la chaîne d’approvisionnement et moins de retards. “Fabriqué en Europe” ne se limite pas à un lieu – c’est notre engagement envers la responsabilité, la proximité et la qualité.

DE HERGESTELLT IN EUROPA: NAH BEI IHNEN

„Hergestellt in Europa” ist mehr als nur ein Label. Seit 1950 steht es im Mittelpunkt des BIC-Versprechens für Qualität und Nachhaltigkeit. Von unseren Ursprüngen in Frankreich bis hin zu personalisierten Kreationen in Tarragona, Spanien, entwerfen und produzieren wir ausgewählte Schreibgeräte und Feuerzeuge lokal, in Ihrer Nähe.

Dieser Ansatz minimiert Transportwege und reduziert unseren ökologischen Fußabdruck durch die Beschaffung von Materialien von europäischen Lieferanten und die Produktion auf Abruf. Unsere nach ISO 14001 und 9001 zertifizierten Anlagen erfüllen höchste Standards in Qualität, Nachhaltigkeit und Arbeitssicherheit.

Die Nähe zu unseren Kunden und Lieferanten ermöglicht schnellere Produktion, bessere Kontrolle der Lieferkette und weniger Verzögerungen. „Hergestellt in Europa” ist nicht nur ein Standort – es steht für unsere Verantwortung, Verbundenheit und Qualität.



IT
MADE IN EUROPE: VICINO A TE

“Made in Europe” è più di un’etichetta. Dal 1950, è al centro dell’impegno di BIC per qualità e sostenibilità. Dalle nostre origini in Francia alle creazioni personalizzate a Tarragona, in Spagna, progettiamo e produciamo localmente strumenti di scrittura e accendini selezionati, rimanendo vicini a voi.

Questo approccio riduce le distanze di trasporto e l’impatto ambientale grazie all’approvvigionamento di materiali da fornitori europei e alla produzione su richiesta. Le nostre strutture certificate ISO 14001 e 9001 rispettano i più alti standard di qualità, sostenibilità e sicurezza dei dipendenti.

Essere vicini ai nostri clienti e fornitori ci permette una produzione più rapida, un maggiore controllo della catena di fornitura e meno ritardi. “Made in Europe” non è solo un luogo: è il nostro impegno per responsabilità, connessione e qualità.

ES
HECHO EN EUROPA: CERCA DE TI

“Hecho en Europa” es más que una etiqueta. Desde 1950, ha sido parte central del compromiso de BIC con la calidad y la sostenibilidad. Desde nuestros orígenes en Francia hasta las creaciones personalizadas en Tarragona, España, diseñamos y producimos localmente instrumentos de escritura y encendedores seleccionados, manteniendo la producción cerca de ti.

Este enfoque minimiza las distancias de envío y reduce nuestra huella ambiental al obtener materiales de proveedores europeos y producir bajo demanda. Nuestras instalaciones, certificadas con ISO 14001 y 9001, cumplen con los más altos estándares de calidad, sostenibilidad y seguridad laboral.

Estar cerca de nuestros clientes y proveedores asegura una producción más rápida, mejor control de la cadena de suministro y menos retrasos. “Hecho en Europa” no es solo un lugar: es nuestro compromiso con la responsabilidad, la conexión y la calidad.

LET'S START FROM THE SOURCE

**Sustainability begins with the materials we choose.
Some may surprise you, but true commitment means thinking creatively.**

Here are some examples:

- Made from scrap fruit and veg trays
- Made from pharmaceutical waste
- Made from recycled car parts

Our Ecolutions® range includes:

- Recycled and recyclable materials
- Biobased materials
- FSC-certified paper from sustainable forests
- Recycled-paper packaging

FR COMMENÇONS À LA SOURCE

La durabilité commence par les matériaux que nous choisissons. Certains vous surprendront peut-être, mais un véritable engagement implique de faire preuve de créativité.

En voici quelques exemples:

- Fabriqué à partir de déchets de barquettes de fruits et légumes
- Fabriqué à partir de déchets pharmaceutiques
- Fabriqué à partir de déchets de pièces automobiles en plastique

Notre gamme Ecolutions® est fabriquée à partir de matériaux durables

- Matériaux recyclés et recyclables
- Matériaux biosourcés
- Papier issu de forêts durables (FSC)
- Emballage en papier recyclé

IT TORNIAMO ALL'ORIGINE

La sostenibilità inizia dai materiali che scegliamo. Alcuni vi sorprenderanno, ma un vero impegno significa pensare in modo creativo.

Ecco alcuni esempi:

- Prodotti con scarti di vassoi di frutta e verdura
- Prodotti con rifiuti farmaceutici
- Prodotti con scarti di plastica provenienti da automobili

La nostra gamma Ecolutions® è realizzata con materiali sostenibili

- Materiali riciclati e riciclabili
- Materiali biobased
- Carta proveniente da foreste sostenibili (FSC)
- Imballaggio in carta riciclata

DE NACHHALTIGKEIT BEGINNT SCHON AM URSPRUNG

Nachhaltigkeit beginnt bei den Materialien, die wir auswählen. Einige werden Sie vielleicht überraschen, aber echtes Engagement bedeutet, kreativ zu denken.

Hier sind einige Beispiele:

- Hergestellt aus Obst- und Gemüseverpackungen
- Hergestellt aus pharmazeutischen Abfällen
- Hergestellt aus den Resten von Plastikautoteilen

Unser Ecolutions®-Sortiment wird aus nachhaltigen Materialien hergestellt

- Recycelte und wiederverwertbare Materialien
- Biobasierte Materialien
- Papier aus nachhaltiger Forstwirtschaft (FSC)
- Verpackung aus recyceltem Papier

ES EMPECEMOS POR EL PRINCIPIO

La sostenibilidad empieza por los materiales que elegimos. Algunos pueden sorprenderle, pero el verdadero compromiso implica pensar de forma creativa.

He aquí algunos ejemplos:

- Fabricado con restos de bandejas de frutas y verduras
- Fabricado a partir de residuos farmacéuticos
- Fabricado con restos de piezas de plástico de coches

Nuestra gama Ecolutions® está fabricada con materiales sostenibles

- Materiales reciclados y reciclables
- Materiales biológicos
- Papel procedente de bosques sostenibles (FSC)
- Envases de papel reciclado



MADE IN SPAIN

Made from scrap plastic car parts.

BIC® MEDIA CLIC GRIP ECOLUTIONS®



BIC® MEDIA CLIC ECOLUTIONS®

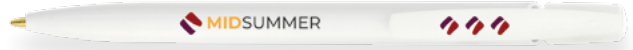

BIC® SUPER CLIP ECOLUTIONS®



MADE IN SPAIN

Made from sugar cane.

BIC® MEDIA CLIC BIOBASED ECOLUTIONS®



FSC and recyclable cardboard.

SPROUT™ graphite pencil



FABRIQUÉ EN FRANCE
MADE IN FRANCE

Made from recycled fridges and yogurt pots.

BIC® EVOLUTION® ECOLUTIONS®



BIC® KIDS EVOLUTION® ECOLUTIONS® COLOURING SET



FABRIQUÉ EN FRANCE
MADE IN FRANCE

Made from pharmaceutical waste.

BIC® PERMANENT MARKER ECOLUTIONS®



BIC® MATIC® ECOLUTIONS®



MADE IN SPAIN

Made from biobased material.

BIC® SUPER CLIP ORIGIN



MADE IN SPAIN

Made from scrap fruit and vegetables trays.

BIC® WIDE BODY™ ECOLUTIONS®



BIC® CLIC STIC ECOLUTIONS®



BIC® ROUND STIC® ECOLUTIONS®



A pen that connects generations

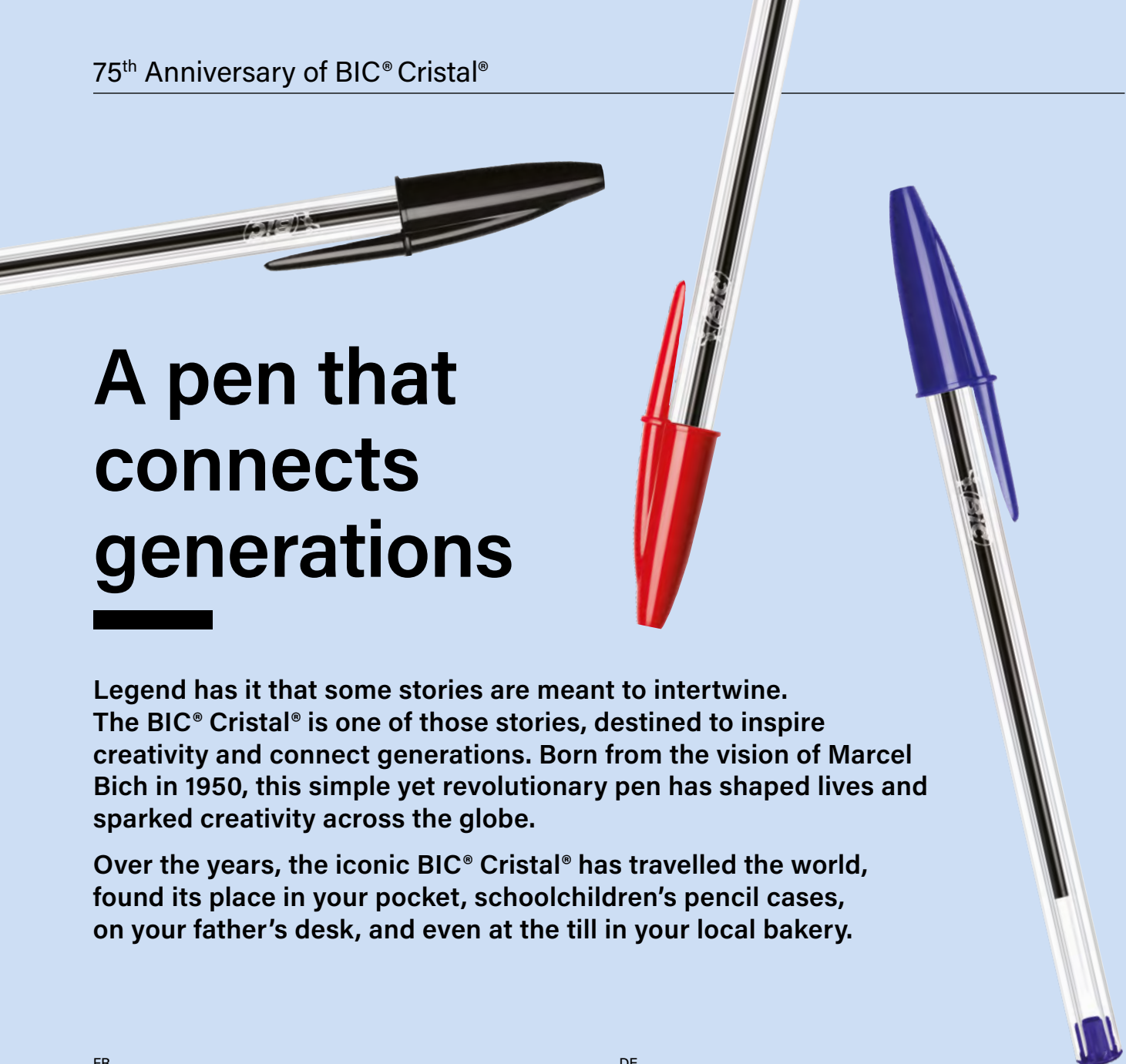

Legend has it that some stories are meant to intertwine. The BIC® Cristal® is one of those stories, destined to inspire creativity and connect generations. Born from the vision of Marcel Bich in 1950, this simple yet revolutionary pen has shaped lives and sparked creativity across the globe.

Over the years, the iconic BIC® Cristal® has travelled the world, found its place in your pocket, schoolchildren's pencil cases, on your father's desk, and even at the till in your local bakery.

FR
UN STYLO QUI RELIE LES GÉNÉRATIONS

La légende dit que certaines histoires sont faites pour s'entrelacer. Le BIC® Cristal® est l'une de ces histoires, destinée à inspirer la créativité et à relier les générations. Né de la vision de Marcel Bich en 1950, ce stylo simple mais révolutionnaire a façonné des vies et éveillé la créativité à travers le monde. Au fil des années, l'émblématique BIC® Cristal® a parcouru le monde, trouvé sa place dans votre poche, dans les trousseaux d'écoliers, sur le bureau de votre père, et même à la caisse de votre boulangerie locale.

IT
UNA PENNA CHE COLLEGA LE GENERAZIONI

La leggenda narra che alcune storie sono destinate a intrecciarsi. La BIC® Cristal® è una di queste storie, creata per ispirare la creatività e unire le generazioni. Nata dalla visione di Marcel Bich nel 1950, questa penna semplice ma rivoluzionaria ha plasmato vite e acceso la creatività in tutto il mondo. Nel corso degli anni, l'iconica BIC® Cristal® ha girato il mondo, trovando posto nella tua tasca, negli astucci dei bambini, sulla scrivania di tuo padre e persino alla cassa del tuo panificio locale.

DE
**EIN KUGELSCHREIBER,
DER GENERATIONEN VERBINDET**

Der Legende nach sind manche Geschichten dazu bestimmt, sich zu verweben. Der BIC® Cristal® ist eine dieser Geschichten, geschaffen, um Kreativität zu inspirieren und Generationen zu verbinden. Aus der Vision von Marcel Bich im Jahr 1950 geboren, hat dieser einfache, aber revolutionäre Kugelschreiber das Leben geprägt und Kreativität auf der ganzen Welt entfacht. Im Laufe der Jahre hat der legendäre BIC® Cristal® die Welt bereist, seinen Platz in Ihrer Tasche, in den Federmäppchen von Schulkindern, auf dem Schreibtisch Ihres Vaters und auch an der Kasse Ihrer örtlichen Bäckerei gefunden.

ES
UN BOLÍGRAFO QUE CONECTA GENERACIONES

La leyenda dice que algunas historias están destinadas a entrelazarse. El BIC® Cristal® es una de esas historias, creada para inspirar creatividad y conectar generaciones. Nacido de la visión de Marcel Bich en 1950, este bolígrafo simple pero revolucionario ha moldeado vidas y desatado creatividad en todo el mundo. A lo largo de los años, el icónico BIC® Cristal® ha viajado por el mundo, encontrando su lugar en tu bolsillo, en los estuches de los alumnos, en el escritorio de tu padre e incluso en la caja de tu panadería local.

A Timeless Storyteller

75TH
ANNIVERSARY OF THE BIC® CRISTAL®

Since 1950, the BIC® Cristal® has been more than just a writing tool; its iconic design has told stories of life, progress and creativity, helping people from various generations and cultures express themselves. Guided by Marcel Bich's vision of providing an affordable, high-quality pen, the Cristal® has witnessed cultural revolutions, artistic movements and business innovations, remaining a symbol of innovation, precision and connection while staying true to its purpose of bringing people together.

And the story is not over.

FR
UN CONTEUR INTEMPOREL

Depuis 1950, le BIC® Cristal® est bien plus qu'un outil d'écriture; son design emblématique a raconté des histoires de vie, de progrès et de créativité, aidant des générations et des cultures variées à s'exprimer. Guidé par la vision de Marcel Bich de fournir un stylo abordable et de haute qualité, le BIC® Cristal® a été témoin de révolutions culturelles, de mouvements artistiques et d'innovations commerciales. Il demeure un symbole d'innovation, de précision et de connexion tout en restant fidèle à son objectif: rapprocher les gens.

IT
UN NARRATORE SENZA TEMPO

Dal 1950, la BIC® Cristal® è molto più di un semplice strumento di scrittura; il suo design iconico ha raccontato storie di vita, progresso e creatività, aiutando persone di generazioni e culture diverse a esprimersi. Guidata dalla visione di Marcel Bich di offrire una penna accessibile e di alta qualità, la Cristal® è stata testimone di rivoluzioni culturali, movimenti artistici e innovazioni aziendali. Rimane un simbolo di innovazione, precisione e connessione, rimanendo fedele al suo scopo di avvicinare le persone.

DE
EIN ZEITLOSER ERZÄHLER

Seit 1950 ist der BIC® Cristal® mehr als nur ein Schreibgerät; sein legendäres Design erzählt Geschichten von Leben, Fortschritt und Kreativität und hilft Menschen aus verschiedenen Generationen und Kulturen, sich auszudrücken. Geleitet von Marcel Bich's Vision, einen erschwinglichen, hochwertigen Kugelschreiber anzubieten, war der BIC® Cristal® Zeuge kultureller Revolutionen, künstlerischer Bewegungen und geschäftlicher Innovationen. Er bleibt ein Symbol für Innovation, Präzision und Verbindung, während er seinem Ziel treu bleibt, Menschen zusammenzubringen.

ES
UN NARRADOR ATEMPORAL

Desde 1950, el BIC® Cristal® ha sido mucho más que una herramienta de escritura; su diseño icónico ha contado historias de vida, progreso y creatividad, ayudando a personas de diversas generaciones y culturas a expresarse. Guiado por la visión de Marcel Bich de proporcionar un bolígrafo accesible y de alta calidad, el BIC® Cristal® ha sido testigo de revoluciones culturales, movimientos artísticos e innovaciones empresariales. Sigue siendo un símbolo de innovación, precisión y conexión, manteniéndose fiel a su propósito de unir a las personas.

BIC® CRISTAL® EXPRESSION



What started as a simple tool for expression has now become an expression in itself. Thanks to advanced digital printing technology, we've transformed the iconic BIC® Cristal® into a canvas for unique branding opportunities. Now, businesses, cultural institutions and cities can personalise the iconic BIC® Cristal® to empower their stories and build lasting connections.

Writes up to
3km



BRITEPIX™ DIGITAL
Full colour possibilities
and large printing areas.



FABRIQUÉ
EN FRANCE 
MADE IN FRANCE

FR
BRAND AN ICON - BIC® CRISTAL® EXPRESSION

Ce qui a commencé comme un simple outil d'expression est aujourd'hui devenu une expression en soi. Grâce à une technologie d'impression numérique avancée, nous avons transformé l'icône BIC® Cristal® en une toile pour des opportunités de marque uniques. Désormais, les entreprises, les institutions culturelles et les villes peuvent personnaliser le BIC® Cristal® pour donner vie à leurs histoires et établir des connexions durables.

IT
BRAND AN ICON - BIC® CRISTAL® EXPRESSION

Quello che è nato come un semplice strumento per l'espressione è ora diventato un'espressione di per sé. Grazie alla tecnologia avanzata di stampa digitale, abbiamo trasformato l'iconica BIC® Cristal® in una tela per opportunità di branding uniche. Ora, aziende, istituzioni culturali e città possono personalizzare la leggendaria BIC® Cristal® per rafforzare le loro storie e creare connessioni durature.

DE
BRAND AN ICON - BIC® CRISTAL® EXPRESSION

Was als einfaches Schreibgerät zur Selbstentfaltung begann, ist nun selbst Mittel zum Ausdruck geworden. Dank fortschrittlicher digitaler Drucktechnologie haben wir den legendären BIC® Cristal® in eine Leinwand für einzigartige Branding-Möglichkeiten verwandelt. Unternehmen, kulturelle Institutionen und Städte können jetzt den legendären BIC® Cristal® personalisieren, um ihre Geschichten zu stärken und dauerhafte Beziehungen aufzubauen.

ES
BRAND AN ICON - BIC® CRISTAL® EXPRESSION

Lo que comenzó como una herramienta sencilla para la expresión se ha convertido ahora en una expresión en sí misma. Gracias a la avanzada tecnología de impresión digital, hemos transformado el icónico BIC® Cristal® en un lienzo para oportunidades únicas de marca. Ahora, empresas, instituciones culturales y ciudades pueden personalizar el icónico BIC® Cristal® para dar fuerza a sus historias y construir conexiones duraderas.

Brand an icon



 **BIC**
Cristal
expression

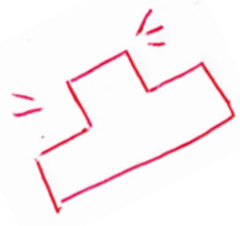
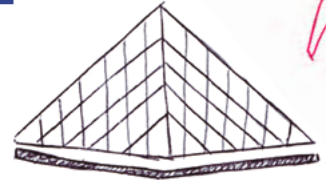
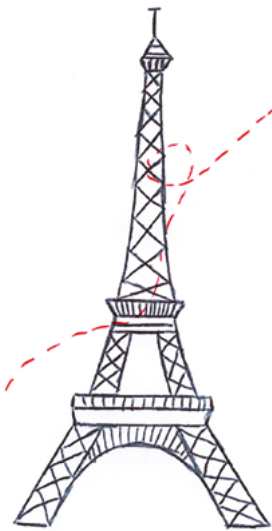

BIC® MEDIA CLIC BIOBASED ECOLUTIONS®

NEW PASTEL COLOURS!

**Style is neither created nor destroyed, it is transformed.
And so it is with our bestseller, now with new colour
options that give it a special, contemporary touch.**



MADE FROM
69% BIO-SOURCED*
MATERIAL



MADE
IN SPAIN

FR

NOUVELLES COULEURS PASTEL!

Le style ne se crée ni ne se détruit, il se transforme.
Et c'est le cas de notre best-seller, désormais disponible
dans de nouvelles options de couleurs qui lui apportent
une touche spéciale et contemporaine.

IT

NUOVI COLORI PASTELLO!

Lo stile non si crea né si distrugge, si trasforma.
Ed è così anche per il nostro best-seller, ora con nuove
opzioni di colore che gli conferiscono un tocco speciale
e contemporaneo.

DE

NEUE PASTELLFARBEN!

Stil wird weder erschaffen noch zerstört, er wird
verwandelt. So ist es auch mit unserem Bestseller,
jetzt mit neuen Farboptionen, die ihm einen
besonderen, zeitgemäßen Touch verleihen.

ES

¡NUEVOS COLORES PASTEL!

El estilo no se crea ni se destruye, se transforma.
Y así ocurre con nuestro éxito de ventas, ahora con
nuevas opciones de colores que le dan un toque
especial y contemporáneo.

Cozy Blue



Peaceful Pink



Inspiring Autumn



BIC® KIDS EVOLUTION® COLOURING SET



Forever Kids

Safe, Fun Colouring for Kids!

Our ultra-resistant, wood-free pencils are the perfect choice for everyday drawing and colouring. They're super easy to sharpen, splinter-free, and safe to use—even if they get chewed on!

The ultimate companion for your little ones' creativity!



MADE FROM
51% RECYCLED
MATERIAL*



FRIDGES AND
YOGURT POTS



SAFE USAGE
FOR KIDS



FR RESTER TOUJOURS ENFANTS

Un coloriage sûr et amusant pour les enfants !
Nos crayons ultra-résistants, sans bois, sont le choix idéal pour le dessin et le coloriage au quotidien. Ils sont très faciles à tailler, sans éclats, et sûrs à utiliser—même s'ils sont mâchouillés !
Le compagnon idéal pour la créativité de vos petits artistes !

IT PER SEMPRE BAMBINI

Colorare in sicurezza e con divertimento per bambini!
Le nostre matite ultra-resistenti, senza legno, sono la scelta perfetta per disegnare e colorare ogni giorno. Sono facilissime da temperare, senza schegge, e sicure da usare—anche se vengono mordicchiate!
Il compagno ideale per la creatività dei vostri piccoli!

DE FÜR IMMER KINDER

Sicheres, spaßiges Malen für Kinder!
Unsere ultra-robusten, holzfreien Buntstifte sind die perfekte Wahl für den täglichen Mal- und Zeichenbedarf. Sie sind super leicht anzuspitzen, splitterfrei und sicher zu benutzen—auch wenn darauf gekaut wird!
Der ultimative Begleiter für die Kreativität der Kleinen!

ES PARA SIEMPRE NIÑOS

¡Colorear seguro y divertido para niños!
Nuestros lápices ultrarresistentes y sin madera son la opción perfecta para dibujar y colorear a diario. Son súper fáciles de afilar, sin astillas y seguros de usar—¡Incluso si los muerden!
El compañero ideal para la creatividad de tus pequeños artistas.

NEW



GENERAL INFORMATION

BIC® PACKAGING

BIC® / DEEP® LIGHTERS AND BIC® CASES

NOTEBOOKS

OTHER WRITING INSTRUMENTS

BIC® WRITING INSTRUMENTS

BIC GRAPHIC



BIC® EZ REACH™

LIGHT UP UNIQUE MOMENTS

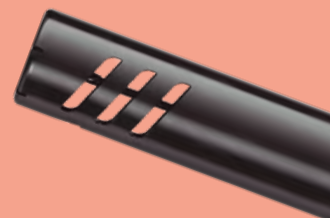

Safe flame occasions are endless with the new **BIC® EZ Reach™**



The most amazing moments begin when someone lights the flame.



Safety Flame.

- Helps keep fingers away from the flame

FR **ILLUMINEZ VOS MOMENTS UNIQUES**

Les occasions avec une flamme sûre sont infinies avec le nouveau BIC® EZ Reach™.

Flamme sûre

- Aide à garder les doigts éloignés de la flamme.

IT **ILLUMINA I MOMENTI UNICI**

Le occasioni con una fiamma sicura sono infinite con il nuovo BIC® EZ Reach™.

Fiamma sicura

- Aiuta a mantenere le dita lontane dalla fiamma.

DE **ENTFACHEN SIE EINZIGARTIGE MOMENTE**

Die Möglichkeiten mit einer sicheren Flamme sind endlos mit dem neuen BIC® EZ Reach™.

Sichere Flamme

- Hilft die Finger von der Flamme fernzuhalten.

ES **ILUMINA MOMENTOS ÚNICOS**

Las ocasiones con una llama segura son infinitas con el nuevo BIC® EZ Reach™.

Llama segura

- Ayuda a mantener los dedos alejados de la llama.

NEW!



A set of BIC® products in customisable boxes

You can go even further in customisation with our FSC cardboard box, customisable on each side. Perfect for combining our iconic BIC® products as a set. A great way to maximise your sales!



FSC AND RECYCLABLE
CARDBOARD



MADE IN
EUROPE

100%
Customisable!

FR

UN ENSEMBLE DE PRODUITS BIC® DANS DES BOÎTES PERSONNALISABLES

Vous pouvez aller encore plus loin dans la personnalisation avec notre boîte en carton FSC, personnalisable sur chaque face. Idéal pour proposer nos produits iconiques BIC® à travers une collection. Une excellente façon de maximiser vos ventes!

Carton FSC et recyclable / Fabriqué en Europe / 100% personnalisable

DE

EIN BIC®-PRODUKTE-SET IN INDIVIDUELL GESTALTbaren VERPACKUNGEN

Auf unseren Verpackungen aus FSC-Karton, die man auf jeder Seite individuell gestalten kann, können Sie sogar noch mehr Werbebotschaften unterbringen. Sie sind ideal, um unsere kultigen BIC®-Produkte als Set zusammenzustellen. Eine großartige Möglichkeit, Ihre Verkäufe zu maximieren!

FSC-zertifizierter und recycelbarer Karton / Hergestellt in Europa / 100% personalisierbar

IT

UN SET DI PRODOTTI BIC® IN CONFEZIONI PERSONALIZZABILI

Si può andare persino oltre nella personalizzazione grazie alla nostra confezione in cartone FSC, personalizzabile su ogni lato. Perfetta per creare un set dei nostri iconici prodotti BIC®. Un ottimo modo per massimizzare le tue vendite!

Cartone FSC e riciclabile / Prodotto in Europa / 100% personalizzabile

ES

UN JUEGO DE PRODUCTOS BIC® EN CAJAS PERSONALIZABLES

Puedes ir aún más lejos en la personalización con nuestra caja de cartón FSC, personalizable por cada lado. Perfecto para combinar nuestros icónicos productos BIC® en un juego. Una excelente forma de maximizar tus ventas!

Cartón FSC y reciclable / Fabricado en Europa / 100% customizable

SPECIAL PACKAGING FOR:

BIC® Cristal® Expression
BIC® Round Stic®
BIC® Style
BIC® Clic Stic

BIC® COLLECTION
BOX SLIM PENS
4 UNITS
529294

NEW!



SPECIAL PACKAGING FOR:

BIC® 4 Colours®
BIC® Wide Body™
BIC® Super Clip
BIC® Brite Liner® Grip
BIC® Grip Roller

BIC® COLLECTION BOX
1 UNIT
991212

BIC® COLLECTION BOX
2 UNITS
991213

BIC® COLLECTION BOX
3 UNITS
991214



BIC
GRAPHIC

BIC®
WRITING INSTRUMENTS

OTHER WRITING
INSTRUMENTS

NOTEBOOKS

BIC® / D/EEP® LIGHTERS
AND BIC® CASES

BIC®
PACKAGING

GENERAL
INFORMATION



Our printing techniques

Our product customisation process is regulated by strict quality controls, is in accordance with all EU regulations and passes 5 different quality tests:

- Adhesion test
- Scratch test (ISO 12137:11)
- Abrasion test
- Tumble test
- Exposure to artificial perspiration test

Quality control tests

Every imprinted order passes 4 different quality controls:

- Cosmetic appearance control
- Imprint colour control
- Imprint adherence control
- Resistance to scratching

FR NOS TECHNIQUES D'IMPRESSION

Notre processus de personnalisation des produits est soumis à des contrôles de qualité stricts, est conforme à toutes les réglementations de l'UE et passe 5 tests de qualité différents :

- Test d'adhésion
- Test de résistance aux rayures (ISO 12137:11)
- Test d'abrasion
- Test de résistance
- Test d'exposition à la transpiration par simulation

TESTS DE CONTRÔLE DE QUALITÉ

Chaque commande de produits imprimés passe 4 contrôles de qualité distincts :

- Contrôle de l'apparence esthétique
- Contrôle de la couleur imprimée
- Contrôle de l'adhérence de l'impression
- Résistance aux rayures

Avec comme garantie nos plus de 50 ans d'expérience !

DE UNSERE DRUCKTECHNIKEN

Unsere Produktpersonalisierung unterliegt strengen Qualitätskontrollen, die sämtlichen EU-Vorschriften entspricht, und durchläuft 5 verschiedene Tests:

- Haftfestigkeitstest
- Kratztest (ISO 12137:11)
- Abriebtest
- Falltest
- Test unter Einwirkung von künstlichem Schweiß

QUALITÄTSKONTROLLEN

Jeder Auftrag für bedruckte Produkte durchläuft 4 verschiedene Qualitätskontrollen:

- Kontrolle des optischen Erscheinungsbildes
- Kontrolle der Aufdruckfarbe
- Kontrolle der Haftung des Aufdrucks
- Kontrolle der Kratzfestigkeit

Mit mehr als 50 Jahren Erfahrung als Garantie!

IT LE NOSTRE TECNICHE DI STAMPA

Il nostro processo di personalizzazione dei prodotti è regolato da severi controlli qualità, è conforme a tutte le normative UE e supera 5 diversi test di qualità:

- Test di adesione
- Test di graffiatura (ISO 12137:11)
- Test di abrasione
- Tumble test
- Test di esposizione alla sudorazione artificiale

TEST DI CONTROLLO QUALITÀ

Ogni ordine stampato supera 4 diversi controlli qualità:

- Controllo dell'aspetto estetico
- Controllo del colore della stampa
- Controllo dell'aderenza della stampa
- Resistenza ai graffi

Con oltre 50 anni di esperienza come garanzia!

ES NUESTRAS TÉCNICAS DE IMPRESIÓN

Nuestro proceso de personalización de productos está regulado por estrictos controles de calidad, cumple toda la normativa de la UE y supera 5 pruebas de calidad diferentes:

- Prueba de adherencia
- Prueba de rayado (ISO 12137:11)
- Prueba de abrasión
- Prueba de caída
- Prueba de exposición a la transpiración artificial

PRUEBAS DE CONTROL DE CALIDAD

Todos los pedidos de productos impresos pasan cuatro controles de calidad distintos:

- Control del aspecto estético
- Control del color de la impresión
- Control de adherencia de la impresión
- Resistencia al rayado

¡Con más de 50 años de experiencia como garantía!



With more than 50 years of experience as a guarantee!



SP

Screen printing

Perfect technique for creating high-quality prints and exact colour matches.

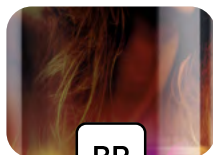

BR

Brilliant

Choose the brilliant finish for a dazzling final effect.



MT

Matt

Use the matt finish to add a touch of elegance to your design.

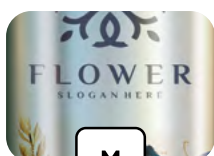

M

Metallic

Create great effects! Metallic effects in text, images and backgrounds.

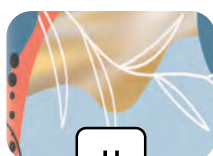

H

Holographic

Stand out from the crowd! Play with gold or silver reflections in your design.



P

Puffy

Highlighted personalisation that gives a relief effect to your logo.

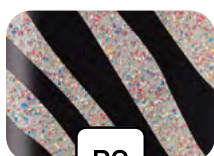

PG

Puffy Glitter

Embellish your designs with the shimmering effect of glitter. See and feel its coloured glitter texture.

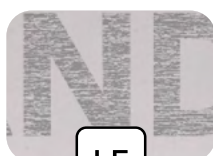

LE

Laser

Laser engraving brings elegance to your communication. Use it to make a lasting impression.



UV

UV

Highlight your brand with a high-gloss finish! Combine a matt and gloss finish to highlight contrasts.



BP

BritePix™ Digital

The solution for full-colour communication. Now on coloured barrels!



BP

BritePix™ Texture

BritePix™ Texture is a fresh addition to our britePix™ concept: now you don't just see the full colour – you can feel it!



BP

BritePix™ Personalisation

BritePix™ personalisation. Personalise each unit within the same britePix™ order.



Your most Colourful Solution



britePix™ DIGITAL

The solution for full colour communication, with photographic excellence, producing a durable imprint that ensures lasting impressions of your logo. Now on coloured barrels!



britePix™ TEXTURE

britePix™ Texture is a fresh addition to our britePix™ concept: now you don't just see the full colour – you can feel it!



britePix™ PERSONALISATION

Personalise each unit within the same britePix™ order.

FR

BRITEPIX™ DIGITAL. La solution pour une communication tout en couleur avec une excellence photographique, une technique d'impression durable, pour que votre logo reste gravé dans les mémoires. Maintenant sur des corps en couleur !

BRITEPIX™ TEXTURE. BritePix™ Texture apporte une nouvelle touche haut de gamme au concept britePix™. Désormais, vous pouvez non seulement voir tout en couleur, mais aussi le toucher !

BRITEPIX™ PERSONALISATION. Personnalisez chaque unité dans une seule et même commande britePix™.

IT

BRITEPIX™ DIGITAL. La soluzione per una comunicazione a colori con eccellenza fotografica, che produce un'impronta durevole garantendo al vostro logo di lasciare un segno indelebile. Ora su fusti colorati!

BRITEPIX™ TEXTURE. BritePix™ Texture è una nuova aggiunta al nostro concetto di britePix™; ora i colori non solo si vedono, ma si sentono!

BRITEPIX™ PERSONALISATION. Personalizza ogni unità all'interno dello stesso ordine britePix™.

DE

BRITEPIX™ DIGITAL. Die Lösung für vollfarbige, fotografisch exzellente Werbung mit einem langlebigen Aufdruck, der dafür sorgt, dass Ihr Logo einen bleibenden Eindruck hinterlässt. Auch auf farbigen Schäften!

BRITEPIX™ TEXTURE. Die britePix™-Textur ist eine frische Ergänzung unseres britePix™-Konzepts: Jetzt sehen Sie nicht nur die volle Farbe - Sie können sie fühlen!

BRITEPIX™ PERSONALISIERUNG. Personalisieren Sie jedes Stück innerhalb einer britePix™ Bestellung.

ES

BRITEPIX™ DIGITAL. La solución para la comunicación a todo color con excelencia fotográfica, que produce una impresión resistente que garantiza impresiones duraderas de tu logotipo. ¡Ahora en cuerpos de colores!

BRITEPIX™ TEXTURE. BritePix™ Texture es una nueva incorporación a nuestro concepto britePix™; ahora no sólo se ve todo el color, ¡También se siente!

BRITEPIX™ PERSONALISATION. Personaliza cada unidad dentro del mismo pedido britePix™.

britepix™



BIC® Evolution® Ecolutions®



BIC® Super Clip Advance



BIC® Round Stic®



BIC® Clic Stic



BIC® Wide Body™



BIC® 4 Colours®



BIC® Media Clic



BIC® XS Finestyle

Contents

BIC[®]
WRITING
INSTRUMENTS

01

BALLPENS

BIC® Cristal® Expression	40
BIC® Cristal® Re'New™	44
BIC® Style	48
BIC® Round Stic®	52
BIC® Round Stic® BGuard™ antibacterial	54
BIC® Round Stic® Ecolutions®	55
BIC® M10® Clic	58
BIC® Media Clic	62
BIC® Media Clic Ecolutions®	63
BIC® Media Clic Grip	65
BIC® Media Clic Grip Ecolutions®	66
BIC® Media Clic BGuard™ antibacterial	72
BIC® Media Clic BGuard™ antimicrobial Ecolutions®	74
BIC® Media Clic Biobased Ecolutions®	76
BIC® Media Clic Biobased BGuard™ antibacterial	80
BIC® Media Clic Shine	82
BIC® Media Clic Glacé	84
BIC® Clic Stic	86
BIC® Clic Stic Ecolutions®	87
BIC® Clic Stic Stylus	90
BIC® Clic Stic Stylus Ecolutions®	90
BIC® Super Clip	96
BIC® Super Clip Ecolutions®	97
BIC® Super Clip Advance	100
BIC® Super Clip Glacé	104
BIC® Super Clip Glacé Advance	104
BIC® Super Clip Soft	106
BIC® Super Clip Soft Advance	106
BIC® Super Clip Origin	108
BIC® Wide Body™	112
BIC® Wide Body™ Ecolutions®	113
BIC® 4 Colours®	120
BIC® 4 Colours® Rainbow Decor	122
BIC® 4 Colours® Bicolor	124
BIC® 4 Colours® Gradient	126
BIC® 4 Colours® Pastel	128
BIC® 4 Colours® Fashion	130
BIC® 4 Colours® Sun	132
BIC® 4 Colours® Fine	134

BIC® 4 Colours® Fluo	136
BIC® 4 Colours® Glacé	138
BIC® 4 Colours® Shine	140
BIC® 4 Colours® Soft	142
BIC® 4 Colours® Wood Style	144
BIC® 4 Colours® Flags Collection	146
BIC® 4 Colours® 3+1 ^{HB}	148

METALLIC PENS

BIC® Metal Pro	150
----------------	-----

ROLLERS AND GELS

BIC® Grip Roller	156
BIC® XS Finestyle	158
BIC® Intensity® Gel Clic	160

HIGHLIGHTERS AND MARKERS

BIC® Brite Liner® Grip	164
BIC® Velleda® White Board Marker Fine	166
BIC® Velleda® White Board Marker Grip	167
BIC® Mark-It Permanent Marker	168
BIC® Permanent Marker Ecolutions®	169

MECHANICAL PENCILS

BIC® Matic®	172
BIC® Matic® Ecolutions®	172
BIC® Media Clic Mechanical pencil	174
BIC® Media Clic Grip Mechanical pencil	175
BIC® Media Clic Grip Mechanical pencil Ecolutions®	175

PENCILS

BIC® Evolution® Ecolutions®	180
BIC® Kids Evolution® Colouring Set	184
Sprout™ Graphite pencil	186

BIC® CRISTAL® EXPRESSION

Brand an Icon.

Experience the evolution of the iconic BIC® Cristal® with BIC® Cristal® Expression. This classic pen now combines timeless design with cutting-edge BritePix™ digital printing technology, offering unique personalisation.



FR

Brand an Icon.

Découvrez l'évolution du célèbre BIC® Cristal® avec le BIC® Cristal® Expression. Ce stylo classique allie désormais un design intemporel à la technologie d'impression numérique de pointe BritePix™, offrant ainsi une personnalisation unique.

IT

Brand an Icon.

Scopri l'evoluzione dell'iconico BIC® Cristal® con il BIC® Cristal® Expression. Questa penna classica unisce ora un design senza tempo alla avanzata tecnologia di stampa digitale BritePix™, offrendo una personalizzazione unica.

DE

Brand an Icon.

Erleben Sie die Evolution des legendären BIC® Cristal® mit dem BIC® Cristal® Expression. Dieser klassische Kugelschreiber vereint nun zeitloses Design mit der hochmodernen BritePix™ Digitaldrucktechnologie und bietet einzigartige Personalisierungsmöglichkeiten.

ES

Brand an Icon.

Experimenta la evolución del icónico BIC® Cristal® con el BIC® Cristal® Expression. Este bolígrafo clásico ahora combina un diseño atemporal con la avanzada tecnología de impresión digital BritePix™, ofreciendo una personalización única.



BIC® CRISTAL® EXPRESSION

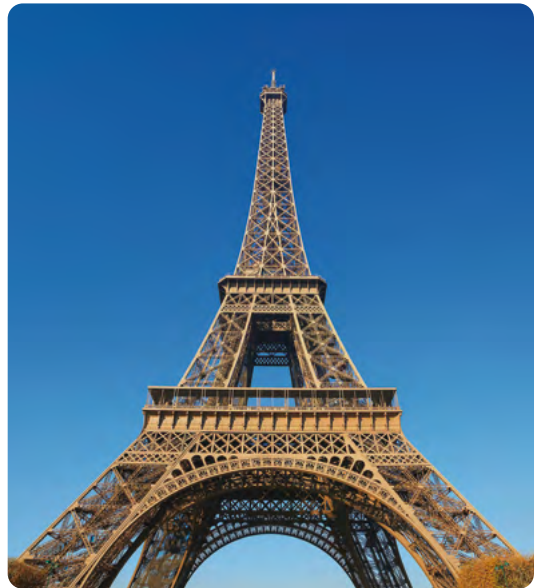
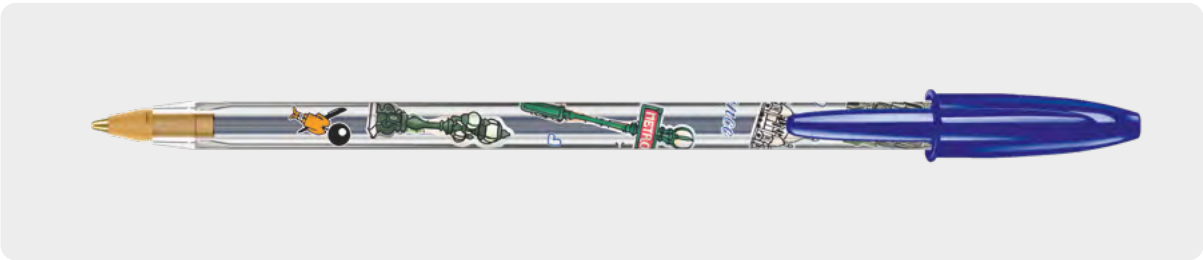

Iconic object of design

1095

BIC® CRISTAL®
EXPRESSION

1095

Colour ink



NEW!



02



03



05



100%

04

FR
Objet emblématique
du design

DE
Legendäres
Designobjekt

IT
Oggetto iconico
di design

ES
Objeto icónico
del diseño

1095

BIC® CRISTAL® EXPRESSION

1095

A BP: BritePix™ Digital

MOQ 250 units

Decoration

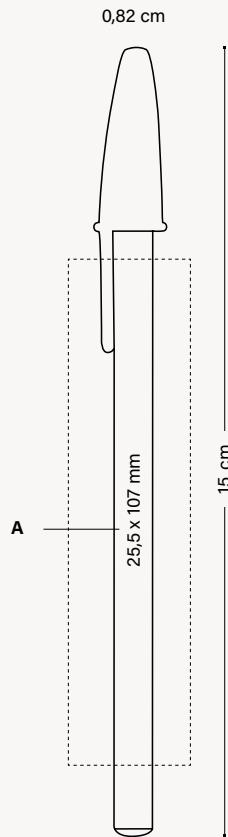

WRITING MODES



PRINTING TECHNIQUES



BRITEPIX™ DIGITAL

SUSTAINABILITY



OPTIONAL SPECIAL PACKAGING



BIC COLLECTION BOX SLIM PENS

New!

+ INFO PAGES 262 TO 266

EXTERNAL PACKAGING



500 ± 3,5 KG

See pages 274-277 for a detailed explanation of the icons

BIC® CRISTAL® RE'NEW™

The iconic BIC® Cristal® in a metal version.

The BIC® Cristal® Re'New™ adds to the iconic BIC® Cristal® original, attaching a sense of modernity to its aluminum matt barrel and the laser engraved BIC® logo. The cap has been also redesigned; it's matt grey and manufactured from 96% recycled plastic. Refillable with blue or black inks. Includes 2 cartridges.

FR

L'icone BIC® Cristal® version métallique.

Le nouveau BIC® Cristal® Re'New™ reprend le design de l'icone BIC® Cristal® Original et ajoute une touche de modernité grâce à son corps au rendu aluminium mat et l'inscription au laser du logo BIC®. Le capuchon a été également redessiné: il est gris mat et fabriqué à partir de plastique recyclé à 96%. Rechargeable à encre bleue ou noire avec 2 recharges incluses.

IT

L'iconica BIC® Cristal® in versione metallica.

Il nuovo BIC® Cristal® Re'New™ riprende il design dell'iconica BIC® Cristal® Original e aggiunge un tocco di modernità grazie al corpo in alluminio opaco e all'iscrizione al laser del logo BIC®. Anche il cappuccio è stato ridisegnato: è grigio opaco e realizzato con plastica riciclata al 96%. Ricaricabile con inchiostro blu o nero con 2 ricariche incluse.

DE

Der legendäre BIC® Cristal® in einer Metallversion.

Der BIC® Cristal® Re'New™ erweitert den klassischen BIC® Cristal® und verleiht ihm mit seinem matteden Aluminiumgehäuse und dem lasergravierten BIC®-Logo einen modernen Touch. Die zwei Nachfüllminen im Lieferumfang sorgen dafür, dass Ihnen über sehr lange Zeit nicht die Tinte ausgeht. Der Kugelschreiber hat einen langlebigen, matt-silbernen Metallschaft und eine dazu passende Kappe aus 96 % recyceltem Kunststoff.

ES

El icónico BIC® Cristal® original en versión metal.

El nuevo BIC® Cristal® Re'New™ añade al icónico BIC® Cristal® original un toque de modernidad con su cuerpo de aluminio mate y el logotipo BIC® grabado con láser. El capuchón también ha sido rediseñado: es gris mate y está fabricado con un 96% de plástico reciclado. Recargable, con tintas azul o negra. Incluye 2 cartuchos.

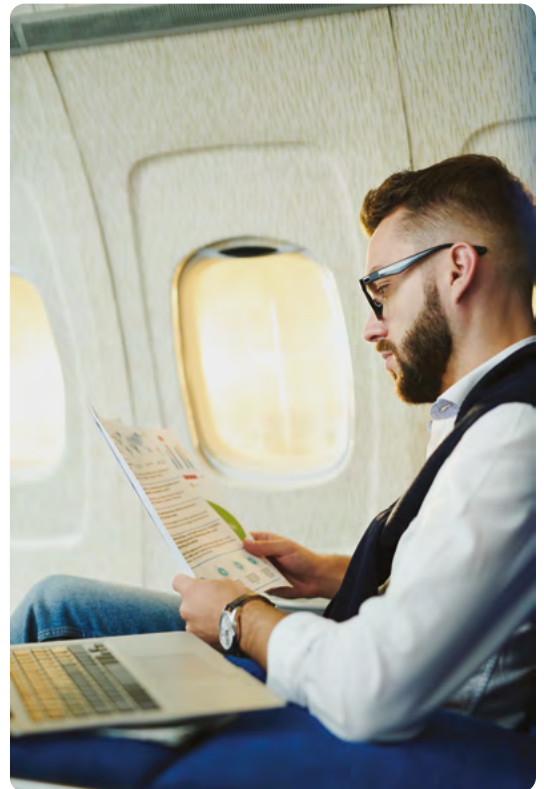

BIC® CRISTAL® RE'NEW™



Elegance dressed in metal.

1090

BIC® CRISTAL®
RE'NEW™

1090

Colour ink



BIC® WINDOW BOX

1 pen + 2 refills



*Your Cristal® Re'New™
comes with this packaging!*

(Included in the price)

FR

**L'élégance vêtue
de métal.**

DE

**Eleganz in Metall
gekleidet.**

IT

**Eleganza vestita
di metallo.**

ES

**Elegancia
vestida de metal.**

1090

BIC® CRISTAL® RE'NEW™

1090

A LE: max. 1 col.

MOQ 25 units

Decoration

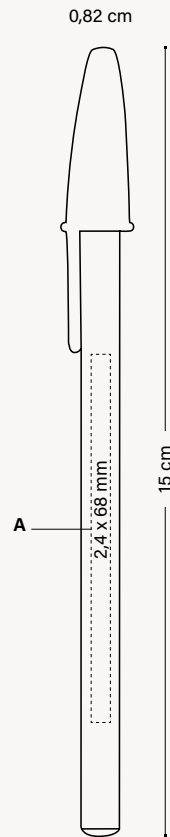

EXTERNAL PACKAGING



WRITING
MODES



PRINTING
TECHNIQUES



SUSTAINABILITY



BIC
GRAPHIC

BIC®
WRITING INSTRUMENTS

OTHER WRITING
INSTRUMENTS

NOTEBOOKS

BIC® / D'JEEP® LIGHTERS
AND BIC® CASES

BIC®
PACKAGING

GENERAL
INFORMATION

See pages 274-277 for a detailed explanation of the icons

BIC® STYLE

Globally renowned BIC® cap design.

The BIC® Style offers excellent
value for money.



FR

**Facilement reconnaissable
dans le monde entier grâce à
son capuchon emblématique.**

Le BIC® Style offre un excellent rapport
qualité-prix.

IT

**Riconoscibile facilmente
grazie al suo tappo iconico.**

BIC® Style offre un eccellente
rapporto qualità-prezzo.

DE

**Weltweit leicht an der
legendären Kappe zu erkennen.**

Der BIC® Style bietet ein
hervorragendes Preis-Leistungs-
Verhältnis.

ES

**Reconocido mundialmente
por su icónico capuchón.**

El BIC® Style ofrece una excelente
relación calidad precio.

1610

BIC® STYLE
1610 Opaque

Colour ink
● ●



01/01

01/03

01/04

01/02

02/02

04

10

100%

●
Only available
in black ink

●
Only available
in blue ink

●
Only available
in black ink

MANUFACTURED
AND PRINTED IN
BIC FACTORIES

REGULATORY
COMPLIANCE

ISO
certified

**WRITING
MODES**

BALLPEN M
0.1 MM

**PRINTING
TECHNIQUES**

SCREEN PRINTING

SUSTAINABILITY

IMPRIM'VERT®

100% ELECTRICITY COMING
FROM RENEWABLE SOURCES

See pages 274-277 for a detailed explanation of the icons

1610

BIC® STYLE
1610 Clear

Colour ink



1610

BIC® STYLE

1610 Opaque
A SP: max. 1 col.

BIC® STYLE

1610 Clear
B SP: max. 1 col.

MOQ 500 units

Decoration

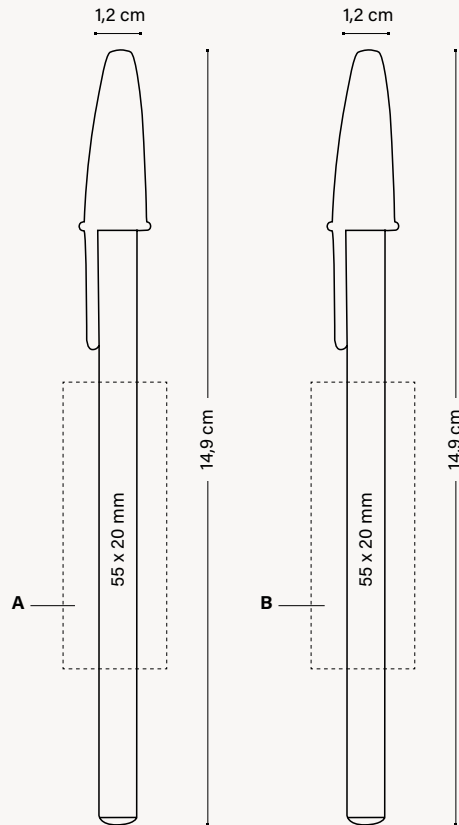

WRITING
MODES



PRINTING
TECHNIQUES



SUSTAINABILITY



OPTIONAL SPECIAL PACKAGING



BIC COLLECTION
BOX SLIM PENS
New!

+ INFO PAGES 262 TO 266

EXTERNAL PACKAGING



Can be used
as bookmark

BIC® ROUND STIC®

The iconic BIC® Round Stic® offers a timeless style and high quality.

Its classic design is easy
to identify and symbolises
long-term reliability.



FR

**L'iconique BIC® Round Stic®
offre un style indémodable
et une très grande qualité.**

Son design classique est facile à
identifier et il est synonyme de fiabilité
à long terme.

IT

**L'iconica BIC® Round Stic®
offre uno stile intramontabile
ed alta qualità.**

Il suo design classico la rende
facilmente riconoscibile ed è prova
di una longeva affidabilità.

DE

**Unser legendärer BIC® Round
Stic® bietet zeitloses Design
in hoher Qualität.**

Sein klassisches Design ist einfach
zu erkennen und steht für lang
anhaltende Zuverlässigkeit.

ES

**El icónico BIC® Round Stic®
ofrece un estilo atemporal
y una alta calidad.**

Su diseño clásico se identifica
fácilmente y simboliza la fiabilidad
a largo plazo.

1010

BIC® ROUND STIC®
1010 Opaque

Colour ink
● ● ●

Red Ink available under request



*Embossed
iconic BIC® brand!*

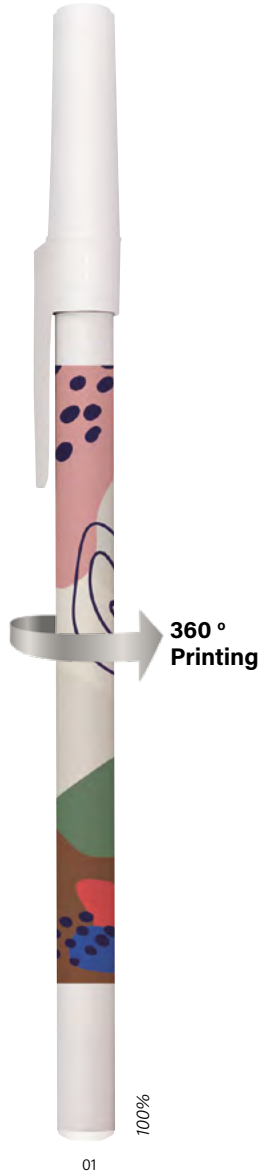

*Only available
on white barrel*



**MIX &
MATCH**



PERSONALIZED
COLOURS



MANUFACTURED
AND PRINTED IN
BIC FACTORIES



MADE
IN SPAIN



REGULATORY
COMPLIANCE



WRITING
MODES



BALLPEN M
0.1 MM

PRINTING
TECHNIQUES



SCREEN PRINTING



DIGITAL

SUSTAINABILITY



IMPRIM'VERT®



100% ELECTRICITY COMING
FROM RENEWABLE SOURCES

See pages 274-277 for a detailed explanation of the icons



1010

BIC® ROUND STIC®
1010 Frosted

Colour ink



Red Ink available under request



69

63

71

66

67

40

68

1011

BIC® ROUND STIC® BGUARD™
ANTIBACTERIAL
1011 Opaque

Colour ink



Red Ink available under request

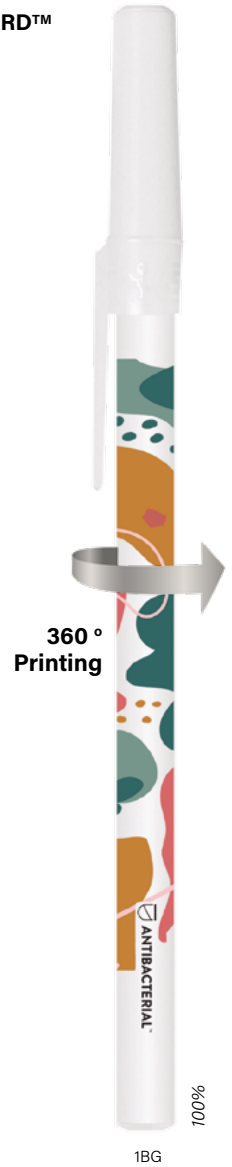

1BG

Only available
on white barrel



ECO version and standard at the same price!

ecolutions®



MADE FROM **98% RECYCLED MATERIAL***
*Excluding ink system

FRUIT AND VEGETABLE TRAYS



MIX & MATCH



PERSONALIZED COLOURS



MANUFACTURED AND PRINTED IN BIC FACTORIES



MADE IN SPAIN



REGULATORY COMPLIANCE



WRITING MODES



BALLPEN M Ø 1 MM

PRINTING TECHNIQUES



SCREEN PRINTING



DIGITAL

SUSTAINABILITY



IMPRIM'VERT®

ecolutions®



FRUIT AND VEGETABLE TRAYS



100% ELECTRICITY COMING FROM RENEWABLE SOURCES

1E10

BIC® ROUND STIC®
1E10 Opaque

Colour ink
● ● ●

Red Ink available under request



1E/8E

1E/7E

1E/3E

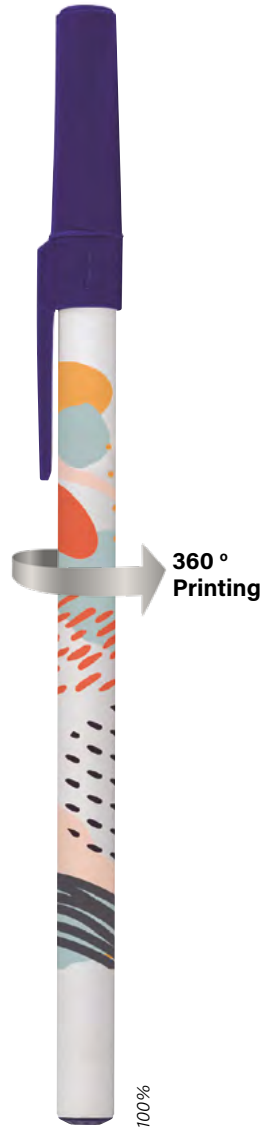

360° Printing

100%

Only available on white barrel



1E10

BIC® ROUND STIC®
1E10 Frosted

Colour ink
● ● ●

Red Ink available under request



2E/8E

2E/7E

2E/3E

100%

*The percentage is calculated based on total weight of the product excluding ink system. Due to the recycled content of the raw materials used to make the pen, we cannot guarantee that the colours shown in the catalogue or colours customised to order will always have the same colour and appearance.

BIC® ROUND STIC®

1010 / 1E10 / 1011

BIC® ROUND STIC®

1010 / **ecolutions®** 1E10 Opaque
 1010 / **ecolutions®** 1E10 Frosted
 1011/ BGuard™ Antibacterial

MOQ 500 units.
 Standard colours combination



No extra charge

BGuard™

ecolutions®



Standard colours combination*

Plug

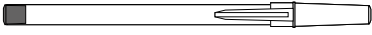

Antibacterial

1BG



Cap

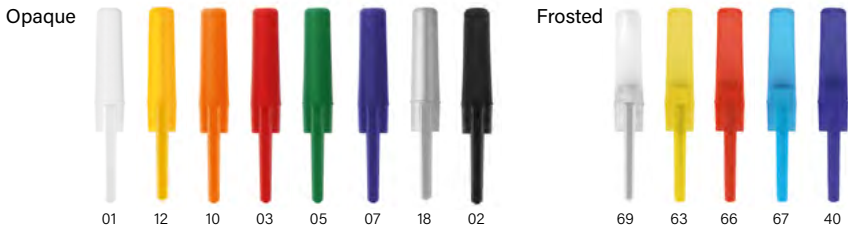
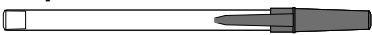

Antibacterial

1BG



Section

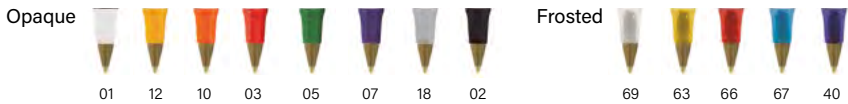
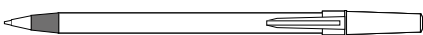

Antibacterial

1BG



Barrel

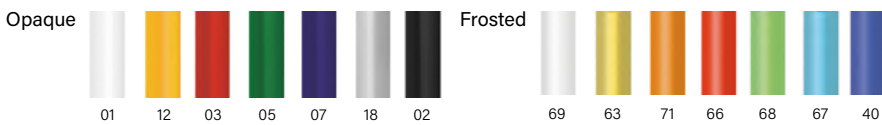

Antibacterial

1BG

Opaque Frosted



Exact colour match: ≥ 10,000 units



**Excluding ink system
 Add the Möbius loop to your artwork at no additional charge. Please specify it on your order. (Möbius loop imprint defaults to left-hand corner.)

*Due to the recycled content of the raw materials used to make the product, we cannot guarantee that the colours shown in the catalogue or colours customised to order will always have the same colour and appearance.
 ** The percentage is calculated based on total weight of the product excluding ink system.

Decoration

1010 / 1E10

BIC® ROUND STIC®

1010

ecolutions® 1E10

A SP: max. 3 col.

B SP: max. 1 col.

C SP: max. 1 col.

D DG: full-colour

(Only available on white barrel)

MOQ 500 units.

1011

**BIC® ROUND STIC®
BGUARD™ ANTIBACTERIAL**

1011

A SP: max. 2 col.

D DG: full colour.

(Only available on white barrel)

MOQ 500 units.

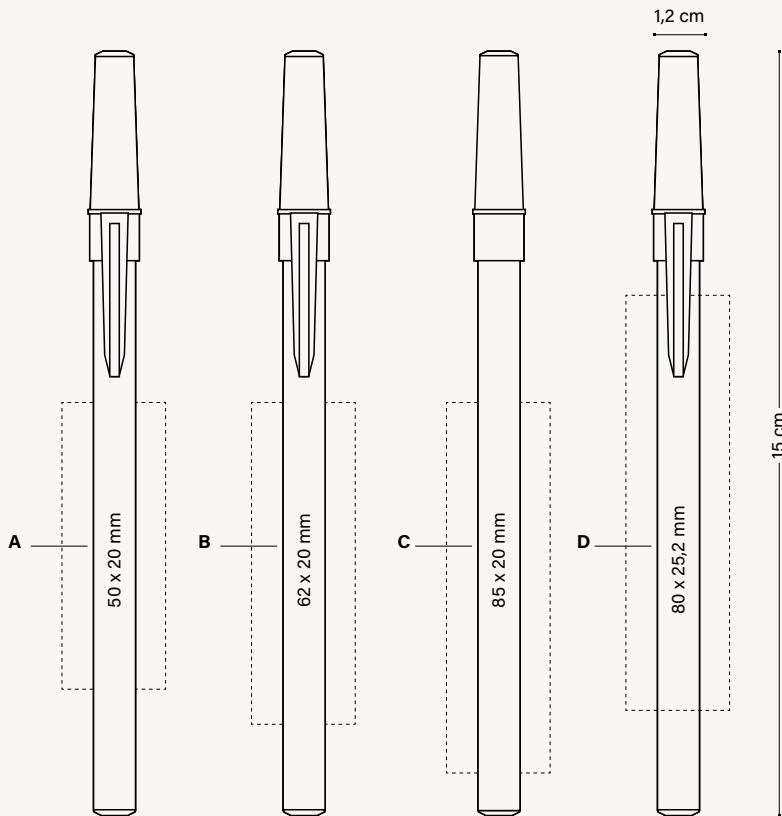

OPTIONAL SPECIAL PACKAGING



PLASTIC
POUCH



BIC COLLECTION
BOX SLIM PENS

New!

+ INFO PAGES 262 TO 266

EXTERNAL PACKAGING



500 ± 2,5 KG

Can be used
as bookmark



PERSONALIZED
COLOURS



MANUFACTURED
AND PRINTED IN
BIC FACTORIES



MADE
IN SPAIN



REGULATORY
COMPLIANCE



WRITING
MODES



BALLPEN M
Ø 1 MM

PRINTING
TECHNIQUES



SCREEN PRINTING



DIGITAL

SUSTAINABILITY



IMPRIM'VERT®

ecolutions®



FRUIT AND
VEGETABLE TRAYS



100% ELECTRICITY COMING
FROM RENEWABLE SOURCES

See pages 274-277 for a detailed explanation of the icons

BIC
GRAPHIC

BIC®
WRITING INSTRUMENTS

OTHER WRITING
INSTRUMENTS

NOTEBOOKS

BIC® / DLEEP® LIGHTERS
AND BIC® CASES

BIC®
PACKAGING

GENERAL
INFORMATION



1590

BIC® M10® CLIC
1590

Colour ink



01

8G

10

14

59

04

02

3D

100%

●
Only available
in black ink

1590

BIC® M10® CLIC
1590

A SP: max. 2 col.

MOQ 500 units

Decoration

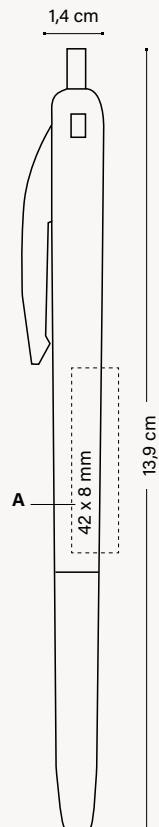

OPTIONAL SPECIAL PACKAGING



PLASTIC
POUCH



WINDOW
BOX

+ INFO PAGES 262 TO 266

*Can be used
as bookmark*

EXTERNAL PACKAGING



500 ± 4,1 KG



MANUFACTURED
AND PRINTED IN
BIC FACTORIES



MADE IN FRANCE



WHITE COLOUR
MANUFACTURED IN SAF



REGULATORY
COMPLIANCE



WRITING
MODES



BALLPEN M
Ø 1 MM

PRINTING
TECHNIQUES



SCREEN PRINTING

SUSTAINABILITY



IMPRIM'VERT®



100% ELECTRICITY COMING
FROM RENEWABLE SOURCES



CHECK OUT THE
VIDEO

See pages 274-277 for a detailed explanation of the icons

BIC
GRAPHIC

BIC®
WRITING INSTRUMENTS

OTHER WRITING
INSTRUMENTS

NOTEBOOKS

BIC® / DJEOP® LIGHTERS
AND BIC® CASES

BIC®
PACKAGING

GENERAL
INFORMATION



One of the best sellers in the industry, a functional and widely recognized design, our BIC® Media Clic is a long lasting product available in different materials. Choose between the Standard, Recycled, Biobased, Antibacterial and premium finishes.

Be inspired with the wide range of finishes and colours, and match them to enhance your brand.

FR

Notre BIC® Media Clic, un best-seller de l'industrie, au design fonctionnel et largement reconnu, est un produit durable disponible dans différents matériaux. Choisissez parmi le Standard, Recyclé, Biobased, Antibactérien et finitions premium.

Laissez-vous inspirer par la vaste gamme de finitions et de couleurs, et associez-les pour mettre en valeur votre marque.

IT

Uno dei bestseller del settore, dal design funzionale e ampiamente riconosciuto, la nostra BIC® Media Clic è un prodotto di lunga durata disponibile in diversi materiali. Scegli tra i modelli Standard, Riciclato, Biobased, Antibatterico e finiture premium.

Lasciati ispirare dall'ampia gamma di finiture e colori e abbinali per valorizzare il tuo marchio.

DE

Einer der Bestseller in der Werbeartikelindustrie, funktional und mit hohem Wiedererkennungswert. Unser BIC® Media Clic ist ein langlebiges Produkt, erhältlich in verschiedensten Materialien. Wählen Sie zwischen Standard-, Recyclen-, Biobasierten-, Antibakteriellen- und Premium-Veredelungen.

Lassen Sie sich von einer Vielzahl an Ausführungen und Farben inspirieren und passen Sie ihn optimal an Ihre Marke an.

ES

Uno de los más vendidos en la industria, con un diseño funcional y ampliamente reconocido, nuestro BIC® Media Clic es un producto duradero disponible en diferentes materiales. Elige entre estándar, reciclado, de material biológico, antibacteriano y acabados premium.

Déjate inspirar por la amplia gama de acabados y colores, y combínalos para realzar tu marca.

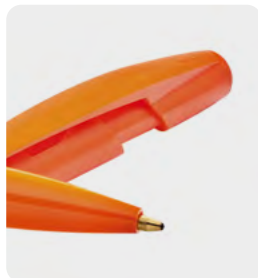

ECOLUTIONS®
GRIP
GRIP ECOLUTIONS®
BGUARD™ ANTIBACTERIAL
BGUARD™ ANTIMICROBIAL
BIOBASED
BIOBASED BGUARD™ ANTIBACTERIAL
SHINE
GLACÉ

1025



Embossed
iconic
BIC® brand!



Also in
Mechanical
pencil

BIC® MEDIA CLIC

1025 Ballpen / 1028 Mechanical pencil (see page 174)

Opaque

Colour ink



Red Ink available under request





ECO version and standard at the same price!

ecolutions®

MADE FROM **98% RECYCLED MATERIAL***
*From barrel

PLASTIC CAR PARTS

1E25

BIC® MEDIA CLIC

1E25 Ballpen
Opaque

Colour ink
● ● ●

MIX & MATCH



PERSONALIZED COLOURS



MANUFACTURED AND PRINTED IN BIC FACTORIES



MADE IN SPAIN



REGULATORY COMPLIANCE



WRITING MODES



BALLPEN M Ø 1 MM

PRINTING TECHNIQUES



SCREEN PRINTING



DIGITAL

SUSTAINABILITY



IMPRIM'VERT®

ecolutions®



PLASTIC CAR PARTS



100% ELECTRICITY COMING FROM RENEWABLE SOURCES

See pages 274-277 for a detailed explanation of the icons

*The percentage is calculated based on total weight of the barrel. Due to the recycled content of the raw materials used to make the product, we cannot guarantee that the colours shown in the catalogue or colours customised to order will always have the same colour and appearance.

1025

Also in
Mechanical
pencil

BIC® MEDIA CLIC

1025 Ballpen / 1028 Mechanical pencil (see page 174)

Frosted

Colour ink



Red Ink available under request



69

63

71

66

4B

68

82

40

67

100%

1020 / 1021

BIC® MEDIA CLIC GRIP

1020 Ballpen

1021 Mechanical pencil (see page 175)

Frosted

Colour ink



Also in
Mechanical
pencil



01/69



71/69



82/69



40/69

100%

MIX &
MATCH



PERSONALIZED
COLOURS



MANUFACTURED
AND PRINTED IN
BIC FACTORIES



MADE
IN SPAIN



REGULATORY
COMPLIANCE



ISO
certified

WRITING
MODES



BALLPEN M
Ø 1 MM

PRINTING
TECHNIQUES



SCREEN PRINTING



DIGITAL

SUSTAINABILITY



IMPRIM'VEERT®



100% ELECTRICITY COMING
FROM RENEWABLE SOURCES

See pages 274-277 for a detailed explanation of the icons

MIX & MATCH



PERSONALIZED COLOURS



MANUFACTURED AND PRINTED IN BIC FACTORIES



MADE IN SPAIN



REGULATORY COMPLIANCE



WRITING MODES



BALLPEN M 0.1 MM

PRINTING TECHNIQUES



SCREEN PRINTING



DIGITAL

SUSTAINABILITY



IMPRIM'VERT®

ecolutions®



PLASTIC CAR PARTS



100% ELECTRICITY COMING FROM RENEWABLE SOURCES

Also in Mechanical pencil

ECO version and standard at the same price!

ecolutions®



MADE FROM 98% RECYCLED MATERIAL*
*From barrel



PLASTIC CAR PARTS

1E20 / 1E21

BIC® MEDIA CLIC GRIP

1E20 Ballpen

1E21 Mechanical pencil (see page 175)

Opaque

Colour ink



01/03



01/05



01/02



01/07

100%

MIX & MATCH No extra charge

MOQ 500 units
ecolutions® Standard colours combination

Plug

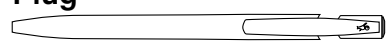

- Opaque 01 12 10 03 5C 2D 13 5G 05 3D 04 07 18 02

- Frosted 69

Clip

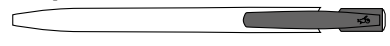

- 01 12 10 03 5C 2D 13 5G 05 3D 04 07 18 02

- Opaque 69

Barrel



- Opaque 01 12 10 03 5C 2D 13 5G 05 3D 04 07 3C 18 02

- Frosted 69 63 71 66 68 82 67 40 4B

Barrel & Grip

- 01/69 71/69 82/69 40/69

Exact colour match: ≥ 10.000 units 1025/1E25
Exact colour match: ≥ 20.000 units 1020/1E20



ecolutions®



Standard colours combination*

Opaque

- 1E 3E

Barrel & Grip Opaque

- 01/03 01/05 01/07 01/02



*From barrel

Add the Möbius loop to your artwork at no additional charge. Please specify "Print the Möbius loop" on your order. (Möbius loop imprint defaults to left-hand corner.)



- PERSONALIZED COLOURS
- MANUFACTURED AND PRINTED IN BIC FACTORIES

- ### PRINTING TECHNIQUES
- SP SCREEN PRINTING
 - DG DIGITAL

- ### WRITING MODES
- BALLPEN M Ø 1 MM

- ### SUSTAINABILITY
- PLASTIC CAR PARTS

*Due to the recycled content of the raw materials used to make the product, we cannot guarantee that the colours shown in the catalogue or colours customised to order will always have the same colour and appearance.

See pages 274-277 for a detailed explanation of the icons

1025 / 1028 / 1E25

BIC® MEDIA CLIC

1025 Ballpen
 1028 Mechanical pencil (see page 174)
 ecolutions® 1E25 Ballpen

A SP: max. 4 col.
B SP: max. 2 col.
C DG: full-colour

MOQ 500 units.

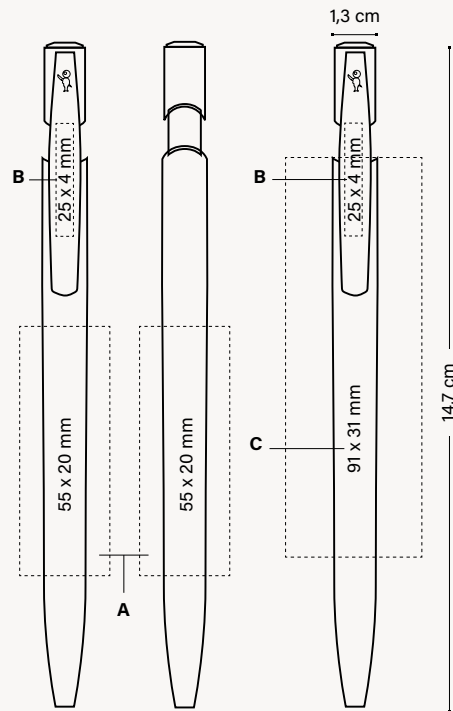

OPTIONAL SPECIAL PACKAGING

EXTERNAL PACKAGING



ECO SLEEVE



PLASTIC POUCH



WINDOW BOX



500 ± 4,1 KG

+ INFO PAGES 262 TO 266

Can be used as bookmark



MANUFACTURED AND PRINTED IN BIC FACTORIES



MADE IN SPAIN

PRINTING TECHNIQUES

SP SCREEN PRINTING

DG DIGITAL

WRITING MODES

BALLPEN M
 Ø 1 MM

SUSTAINABILITY

PLASTIC CAR PARTS

1020 / 1E20 / 1021 / 1E21

BIC® MEDIA CLIC GRIP

1020 Ballpen
1021 Mechanical pencil
(see page 175)

D SP: max. 4 col.

E SP: max. 2 col.

F DG: full-colour

MOQ 500 units.

ecolutions® 1E20 Ballpen

ecolutions® 1E21 Mechanical pencil
(see page 175)

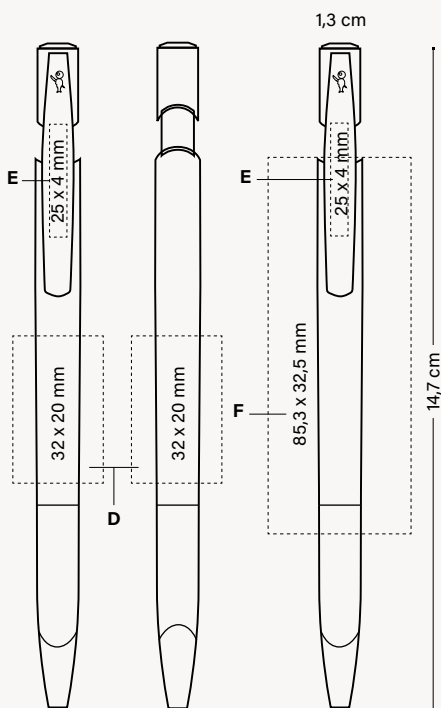

OPTIONAL SPECIAL PACKAGING

EXTERNAL PACKAGING



ECO SLEEVE

+ INFO PAGES 262 TO 266



PLASTIC POUCH

Can be used as bookmark



WINDOW BOX



500 ± 4,3 KG



MANUFACTURED AND PRINTED IN BIC FACTORIES



MADE IN SPAIN

PRINTING TECHNIQUES

SP SCREEN PRINTING

DG DIGITAL

WRITING MODES

BALLPEN M Ø 1 MM

SUSTAINABILITY

PLASTIC CAR PARTS

Permanent surface protection of the pen against microorganisms.

BG GUARD™

FR

Protection permanente de la surface du stylo contre les micro-organismes.

Testé selon un protocole antibactérien

 **ANTIBACTERIAL™**

99,9 % de protection contre les bactéries en 24h

 **ANTIMICROBIAL™**

99,9 % de protection contre les bactéries en 24h

93 % de réduction virale en 24h Inhibition des champignons 24h

IT

Protezione permanente della superficie della penna contro i microrganismi.

Test di protocollo antibatterico

 **ANTIBACTERIAL™**

Protezione batterica 99% in 24h

 **ANTIMICROBIAL™**

99,9% di protezione contro i batteri in 24 ore

93% di riduzione virale in 24 ore Inibizione fungina 24 ore

DE

Permanenter Oberflächenschutz des Kugelschreibers gegen Mikroorganismen.

Antibakterielles Testprotokoll

 **ANTIBACTERIAL™**

99% Bakterienchutz in 24h

 **ANTIMICROBIAL™**

99,9 % Schutz vor Bakterien in 24 Std.

93 % Virusreduktion in 24 Std. Pilzhemmung 24 Std.

ES

Protección permanente de la superficie del bolígrafo contra microorganismos.

Test protocolo Anti-bacterias

 **ANTIBACTERIAL™**

Protección contra las bacterias 99% en 24h

 **ANTIMICROBIAL™**

99,9% de protección contra bacterias en 24h

93% de reducción viral en 24h Inhibición de hongos 24h

 **ANTIBACTERIAL™**



Bacteria
elimination



Entire pen
protection



Timeless
protection



Antibacterial
Test protocol

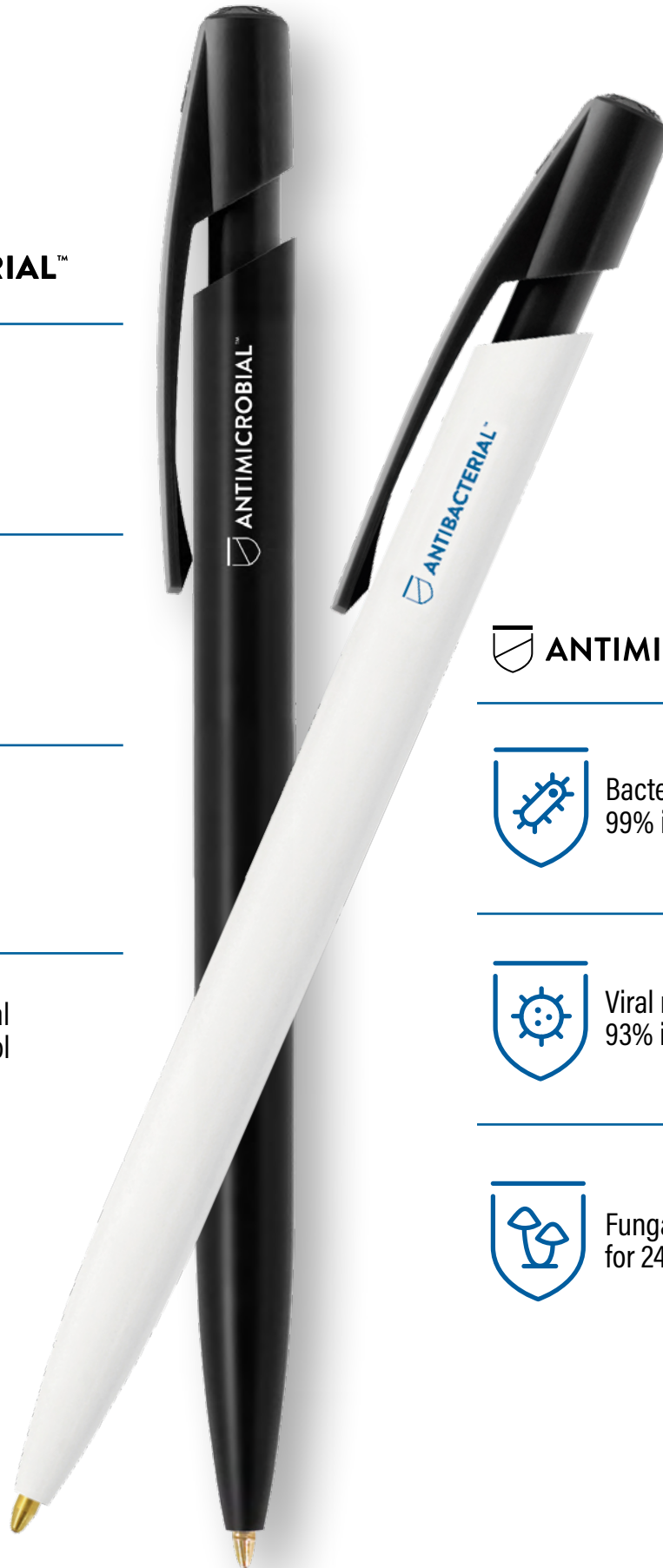

1E26

1026

 **ANTIMICROBIAL™**



Bacteria elimination
99% in 24h



Viral reduction
93% in 24 h



Fungal inhibition
for 24 h

BIC® MEDIA CLIC BGUARD™ ANTIBACTERIAL

BGUARD™



Bacteria elimination



Entire pen protection



Timeless protection



Antibacterial Test protocol

britePix DIGITAL THE SOLUTION FOR FULL COLOUR COMMUNICATION!

1026

BIC® MEDIA CLIC BGUARD™ ANTIBACTERIAL

1026: antibacterial logo
Opaque

Colour ink



Red Ink available under request



1BG

2BG

100%

MIX & MATCH

No extra charge

MOQ 500 units
Standard colours combination

Plug



Opaque 1BG 2BG

Clip



Opaque
1BG 2BG

Barrel



Opaque
1BG 2BG

Exact colour match: ≥ 10.000 units



Iconic BIC® Boy and Antibacterial logo always visible!

ANTIBACTERIAL™

Decoration

1026

**BIC® MEDIA CLIC BGUARD™
ANTIBACTERIAL**

1026: antibacterial logo

A SP: max. 2 col.
B SP: max. 1 col.

MOQ 500 units.

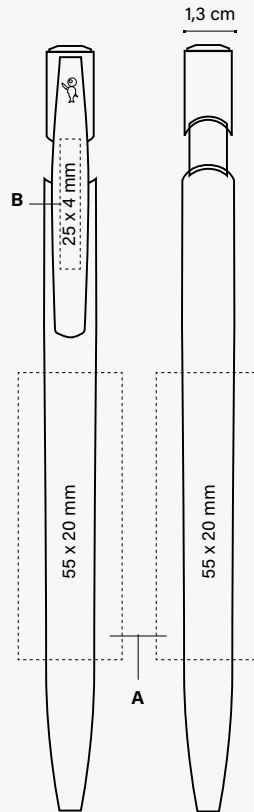

PERSONALIZED COLOURS



MANUFACTURED AND PRINTED IN BIC FACTORIES



MADE IN SPAIN



REGULATORY COMPLIANCE



WRITING MODES



BALLPEN M Ø 1 MM

PRINTING TECHNIQUES



SCREEN PRINTING

SUSTAINABILITY



100% ELECTRICITY COMING FROM RENEWABLE SOURCES

OPTIONAL SPECIAL PACKAGING



ECO SLEEVE

+ INFO PAGES 262 TO 266



PLASTIC POUCH



WINDOW BOX

Can be used as bookmark

EXTERNAL PACKAGING



500 ± 4,1 KG

See pages 274-277 for a detailed explanation of the icons

BIC® MEDIA CLIC BGUARD™ ANTIMICROBIAL ECOLUTIONS®



ANTIMICROBIAL™* =



Bacteria elimination
99% in 24h

+



Viral reduction
93% in 24 h

+



Fungal inhibition
for 24 h

BGUARD™

ecolutions®



MADE FROM 98%
RECYCLED MATERIAL**
**From barrel

PLASTIC
CAR PARTS



1E26

BIC® MEDIA CLIC BGUARD™ ANTIMICROBIAL ECOLUTIONS®

ecolutions® 1E26: antimicrobial logo
Opaque

Colour ink



Red Ink available under request



3E

1E

100%

100%

MIX & MATCH

No extra charge



Add the Möbius loop to your artwork at no additional charge. Please specify it on your order. (Möbius loop imprint defaults to left-hand corner.)

**From barrel

MOQ 500 units
Standard colours combination

Plug

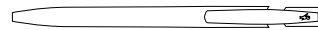

Opaque 1BG 2BG

Clip

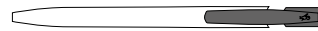

Opaque 1BG 2BG

Barrel



Opaque 1E 3E

Exact colour match: ≥ 10.000 units



*99.9% of bacteria is eliminated from the surface in 24 hours (and more than 30% in 2 hours).

Tested under ISO 22196 protocol adapted to real usage of the pen.

93% of viruses, Sars-Cov-2 Coronavirus causing Covid-19 disease, are eliminated from the surface in 24 hours, (and around 50% in 2 hours).

Tested under ISO 22196 protocol adapted to real usage of the pen.

Fungi present on the surface is inhibited within 24 hours.

Tested under ISO 22196 protocol adapted to fungi and to real usage of the pen.

** The percentage is calculated based on total weight of the barrel. Due to the recycled content of the raw materials used to make the product, we cannot guarantee that the colours shown in the catalogue or colours customised to order will always have the same colour and appearance.



Entire pen protection



Timeless protection



Antibacterial Test protocol



Adapted to fungus test protocol



Antiviral test protocol



PERSONALIZED COLOURS



MANUFACTURED AND PRINTED IN BIC FACTORIES



MADE IN SPAIN



REGULATORY COMPLIANCE



ISO certified



WRITING MODES



BALLPEN M Ø 1 MM



PRINTING TECHNIQUES



SP SCREEN PRINTING



SUSTAINABILITY



IMPRIM'VERT®



eColutions®



PLASTIC CAR PARTS



100% ELECTRICITY COMING FROM RENEWABLE SOURCES

Decoration

1E26

BIC® MEDIA CLIC BGUARD™ ANTIMICROBIAL ECOLUTIONS®

ecolutions® 1E26: antimicrobial logo

A SP: max. 2 col.

B SP: max. 2 col.

MOQ 500 units.

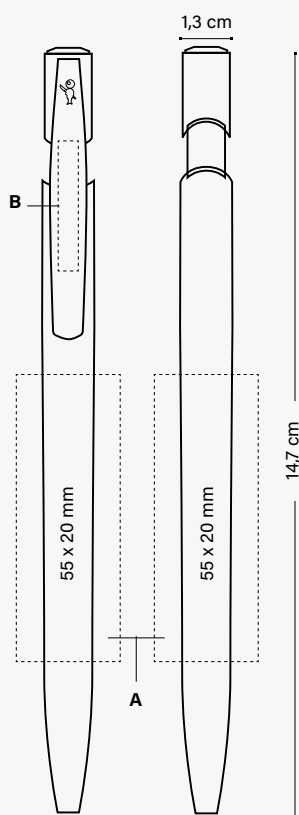

OPTIONAL SPECIAL PACKAGING



ECO SLEEVE

+ INFO PAGES 262 TO 266



PLASTIC POUCH

Can be used as bookmark



WINDOW BOX

EXTERNAL PACKAGING



500 ± 4,1 KG

BIC GRAPHIC

BIC® WRITING INSTRUMENTS

OTHER WRITING INSTRUMENTS

NOTEBOOKS

BIC® / D/DEEP® LIGHTERS AND BIC® CASES

BIC® PACKAGING

GENERAL INFORMATION

See pages 274-277 for a detailed explanation of the icons

The top priority of the ballpen life cycle is sustainability.

BIOBASED

FR

La première priorité pour le cycle de vie du stylo est la viabilité écologique

BIC® MEDIA CLIC BIOBASED ECOLUTIONS® est composé à 69% de matières biosourcées dans le corps du stylo et à 100% de colorants biosourcés.

100% électricité d'énergie renouvelable. 100% de l'électricité de notre usine de production et d'impression provient d'énergies renouvelables.

Transport à faible impact:

Production, impression, matière première.

IT

La sostenibilità è la sua priorità

BIC® MEDIA CLIC BIOBASED ECOLUTIONS® è realizzata con il 69% di materiale biobased nel fusto e con il 100% di coloranti biobased.

100 % elettricità da fonti rinnovabili. L'energia per la produzione e la stampa nelle nostre strutture deriva al **100% da fonti rinnovabili.**

Basso impatto di trasporto:

Produzione, stampa e anche materie prime.

DE

Nachhaltigkeit ist die Priorität im Lebenszyklus der Kugelschreiber.

BIC® MEDIA CLIC BIOBASED ECOLUTIONS® besteht zu 69 % aus biobasiertem Material im Schaft und zu 100 % aus biobasierten Farbstoffen.

Strom zu 100 % aus erneuerbaren Energiequellen: Unsere Fabrik und Druckanlagen werden mit Strom betrieben, **der zu 100 % aus erneuerbaren Quellen stammt.**

Geringe Transportauswirkungen:

bei Produktion, Druck und sogar Rohmaterial.

ES

La prioridad del ciclo de vida del bolígrafo es la sostenibilidad

BIC® MEDIA CLIC BIOBASED ECOLUTIONS® está fabricada con un 69% de material biobasado en el cuerpo y con un 100% de colorantes biobasados.

100 % electricidad de fuentes renovables. Nuestra fábrica e instalaciones de impresión están alimentadas **con electricidad producida 100% a partir de fuentes renovables.**

Transporte de bajo impacto: Producción, impresión e incluso la materia prima.



BIOBASED PEN

The barrel is made of **biobased material**.



Electricity from 100% renewable energy sources.

Our factory and printing facilities are powered by electricity that comes from 100% renewable sources.



Low transport impact:

for production, printing and even raw materials.



Made to last:

- More than 10,000 clicks
- Increased visibility for your brand
- Break resistant clip

**69%
Biobased
MATERIAL***

**100%
Biobased
COLOURANTS**

BIOBASED ecolutions®

MADE FROM
69% BIO-SOURCED*
MATERIAL

MIX & MATCH



PERSONALIZED COLOURS



MANUFACTURED AND PRINTED IN BIC FACTORIES



MADE IN SPAIN



REGULATORY COMPLIANCE



WRITING MODES



BALLPEN M 0.1 MM

PRINTING TECHNIQUES



SCREEN PRINTING



DIGITAL

SUSTAINABILITY



IMPRIM'VERT®

ecolutions®



SUGAR CANE



100% ELECTRICITY COMING FROM RENEWABLE SOURCES

1972

BIC® MEDIA CLIC BIOBASED ECOLUTIONS®

1972 Ballpen

Opaque

Colour ink



Red Ink available under request

NEW COLOURS!



14A

4M

9C

12BIO

03BIO

04BIO

02BIO

05BIO

01BIO

100%

Available on white barrel



* The percentage is calculated based on total weight of the barrel. Due to the natural content of the raw materials used to make the product, we cannot guarantee that the colours shown in the catalogue or colours customised to order will always have the same colour and appearance.



SUGAR CANE

MIX & MATCH No extra charge

BIC GRAPHIC

BIC® WRITING INSTRUMENTS

MOQ 500 units
Standard colours combination

Plug



Clip

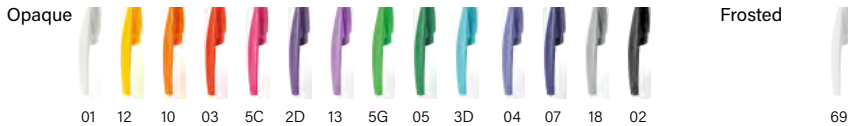

Barrel

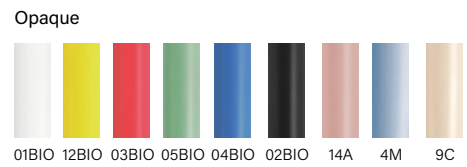

Exact colour match:
≥ 10.000 units

Decoration

1972

BIC® MEDIA CLIC BIOBASED ECOLUTIONS®

1972

A SP: max. 2 col.

B SP: max. 2 col.

C DG: full-colour

MOQ 500 units.

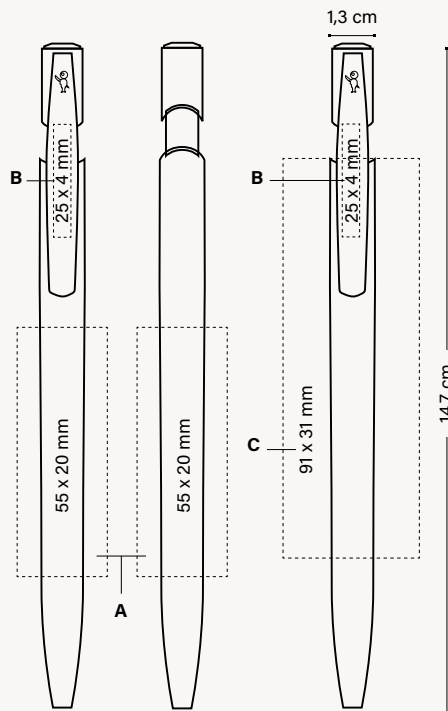

MANUFACTURED AND PRINTED IN BIC FACTORIES



MADE IN SPAIN

WRITING MODES



BALLPEN M
Ø 1 MM

PRINTING TECHNIQUES



SCREEN PRINTING



DIGITAL

SUSTAINABILITY



SUGAR CANE

OTHER WRITING INSTRUMENTS

NOTEBOOKS

BIC® / DLEEP® LIGHTERS AND BIC® CASES

BIC® PACKAGING

GENERAL INFORMATION

OPTIONAL SPECIAL PACKAGING



ECO SLEEVE



PLASTIC POUCH



WINDOW BOX

EXTERNAL PACKAGING



500 ± 4,3KG

+ INFO PAGES 262 TO 266

Can be used as bookmark

* Due to the natural content of the raw materials used to make the product, we cannot guarantee that the colours shown in the catalogue or colours customised to order will always have the same colour and appearance.

BIC® MEDIA CLIC BIOBASED BGUARD™ ANTIBACTERIAL

MIX & MATCH



PERSONALIZED COLOURS



MANUFACTURED AND PRINTED IN BIC FACTORIES



MADE IN SPAIN



REGULATORY COMPLIANCE



WRITING MODES



BALLPEN M
Ø 1 MM

PRINTING TECHNIQUES



SCREEN PRINTING

SUSTAINABILITY



IMPRIM'VERT®



SUGAR CANE



100% ELECTRICITY COMING FROM RENEWABLE SOURCES

BGUARD™



Bacteria elimination



Entire pen protection



Timeless protection



Antibacterial Test protocol

BIOBASED eolutions®

MADE FROM
69% **BIO-SOURCED***
MATERIAL

1973

BIC® MEDIA CLIC BIOBASED BGUARD™ ANTIBACTERIAL

1973 Ballpen
Opaque

Colour ink



Red Ink available under request



02



01

100%

*The percentage is calculated based on total weight of the barrel. Due to the natural content of the raw materials used to make the product, we cannot guarantee that the colours shown in the catalogue or colours customised to order will always have the same colour and appearance.



SUGAR CANE

MIX & MATCH No extra charge

MOQ 500 units. Standard colours combination.

Plug

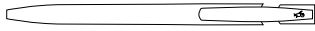

Opaque

01BG 02BG

Clip

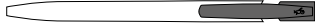

Opaque



01BG 02BG

Barrel



Opaque



01 02

Exact colour match: ≥ 10.000 units



1973

**BIC® MEDIA CLIC
BIOBASED
BGUARD™
ANTIBACTERIAL**

1973

A SP: max. 2 col.

B SP: max. 2 col.

MOQ 500 units.

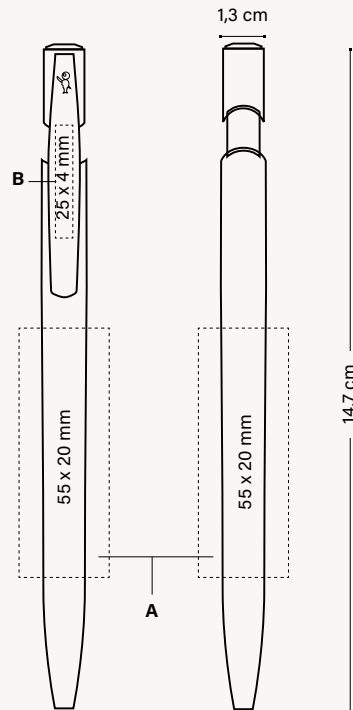

Decoration



PERSONALIZED COLOURS



MANUFACTURED AND PRINTED IN BIC FACTORIES



MADE IN SPAIN

WRITING MODES



BALLPEN M 0.1 MM

PRINTING TECHNIQUES



SCREEN PRINTING

SUSTAINABILITY



SUGAR CANE

OPTIONAL SPECIAL PACKAGING

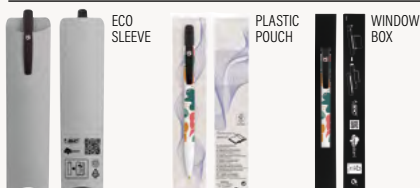

+ INFO PAGES 262 TO 266

Can be used as bookmark

EXTERNAL PACKAGING



250 ± 4,3 KG

BIC GRAPHIC

BIC® WRITING INSTRUMENTS

OTHER WRITING INSTRUMENTS

NOTEBOOKS

BIC® / DLEEP® LIGHTERS AND BIC® CASES

BIC® PACKAGING

GENERAL INFORMATION

*Due to the natural content of the raw materials used to make the product, we cannot guarantee that the colours shown in the catalogue or colours customised to order will always have the same colour and appearance.

1975

BIC® MEDIA CLIC SHINE

1975 Ballpen

Opaque

Colour ink



Red Ink available under request



47



26

100%

MIX & MATCH No extra charge

MOQ 500 units. Standard colours combination.

Plug

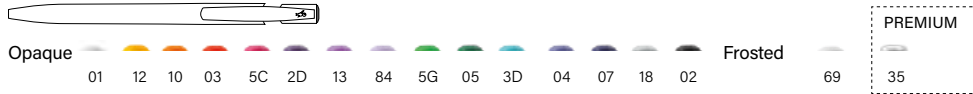

Clip

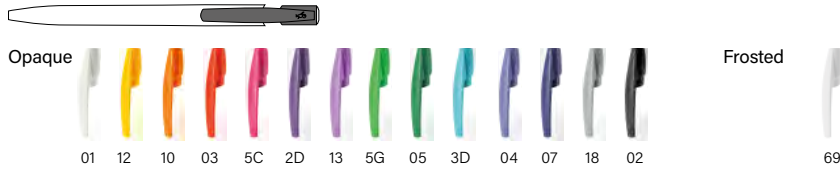

Barrel

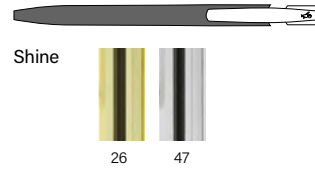

Decoration

1975

BIC® MEDIA CLIC SHINE

1975
A SP: max. 2 col.
B SP: max. 2 col.
 MOQ 500 units.

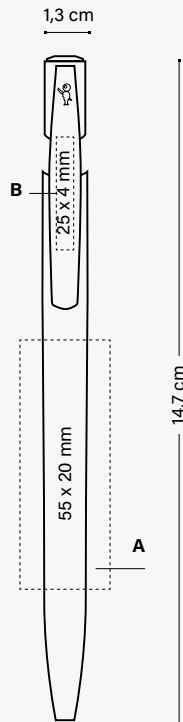

OPTIONAL SPECIAL PACKAGING



+ INFO PAGES 262 TO 266

Can be used as bookmark

EXTERNAL PACKAGING



WRITING MODES



PRINTING TECHNIQUES



SUSTAINABILITY



See pages 274-277 for a detailed explanation of the icons

BIC® MEDIA CLIC GLACÉ

Our bestseller in elegant colours.

1030

BIC® MEDIA CLIC GLACÉ

1030 Opaque

Colour ink



Red Ink available under request



47G



76



03G



05G



04G



14G

FR
**Des couleurs
élégantes pour
notre best-seller.**

DE
**Elegante Farben für
unseren Bestseller.**

IT
**Il nostro best seller
in abito elegante.**

ES
**Colores elegantes
en nuestro best seller.**

MIX & MATCH No extra charge

MOQ 500 units
Standard colours combination

Plug



Clip

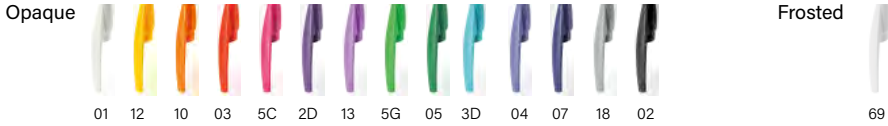

Barrel

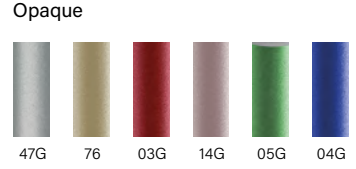

Decoration

1030

BIC® MEDIA CLIC GLACÉ

1030

A SP: max. 2 col.

B SP: max. 2 col.

MOQ 500 units.

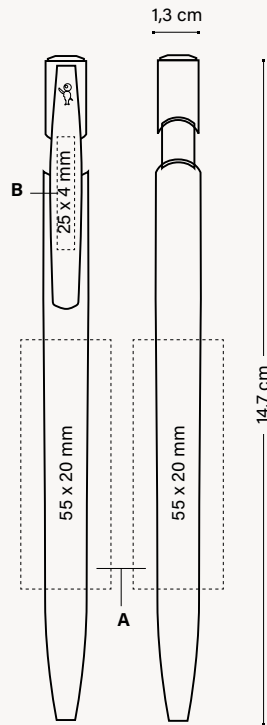

OPTIONAL SPECIAL PACKAGING



+ INFO PAGES 262 TO 266



Can be used as bookmark



EXTERNAL PACKAGING



500 ± 4,1 KG



WRITING MODES



PRINTING TECHNIQUES



SUSTAINABILITY

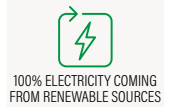

See pages 274-277 for a detailed explanation of the icons

BIC® CLIC STIC

**Modern, flexible,
reliable. That's how
BIC® Clic Stic is!**



*Thousands of colour
combinations!*

FR
**Moderne, souple, fiable.
Le BIC® Clic Stic est ainsi!**

DE
**Modern, flexibel, zuverlässig.
So ist der BIC® Clic Stic!**

IT
**Moderna, flessibile, affidabile.
Ecco com'è BIC® Clic Stic !**

ES
**Moderno, flexible, fiable.
¡Así es BIC® Clic Stic!**

1000

BIC® CLIC STIC
1000 Opaque

Colour ink
● ● ● ● ● ●



Iconic
BIC® Boy
is embossed

Available on
white barrel



ECO version and
standard at the same price!

ecolutions®



MADE FROM **87%
RECYCLED MATERIAL***
*Excluding ink system

FRUIT AND
VEGETABLE TRAYS



1E00

BIC® CLIC STIC
1E00 Opaque

Colour ink
● ● ● ● ● ●



Available on
white barrel



**MIX &
MATCH**



PERSONALIZED
COLOURS



MANUFACTURED
AND PRINTED IN
BIC FACTORIES



MADE IN SPAIN



REGULATORY
COMPLIANCE



WRITING
MODES



BALLPEN M
0.1 MM

PRINTING
TECHNIQUES



SCREEN PRINTING



DIGITAL

SUSTAINABILITY



IMPRIM'VERT®



FRUIT AND
VEGETABLE TRAYS



100% ELECTRICITY COMING
FROM RENEWABLE SOURCES

*The percentage is calculated based on total weight of the pen excluding ink system. Due to the recycled content of the raw materials used to make the product, we cannot guarantee that the colours shown in the catalogue or colours customised to order will always have the same colour and appearance.

ECO version and standard at the same price!

ecolutions®

MADE FROM **87% RECYCLED MATERIAL***
 *Excluding ink system

FRUIT AND VEGETABLE TRAYS



1000

BIC® CLIC STIC
 1000 Frosted

Colour ink
 ● ● ●

Red Ink available under request



1E00

BIC® CLIC STIC
 1E00 Frosted

Colour ink
 ● ● ●

Red Ink available under request



*The percentage is calculated based on total weight of the pen excluding ink system. Due to the recycled content of the raw materials used to make the product, we cannot guarantee that the colours shown in the catalogue or colours customised to order will always have the same colour and appearance.

1005

**BIC® CLIC STIC
SOFTFEEL®**
1005 Opaque

Colour ink
● ● ●

*Red Ink available
under request*



20



07



02

100%

1005

**BIC® CLIC STIC
SOFTFEEL®**
1005 Frosted

Colour ink
● ● ●

*Red Ink available under
request*



40

100%

**MIX &
MATCH**



PERSONALIZED
COLOURS



MANUFACTURED
AND PRINTED IN
BIC FACTORIES



MADE IN SPAIN



REGULATORY
COMPLIANCE



WRITING
MODES



BALLPEN M
0.1 MM

PRINTING
TECHNIQUES



SCREEN PRINTING



DIGITAL

SUSTAINABILITY



IMPRIM'VEERT®

eCOlutions®



FRUIT AND
VEGETABLE TRAYS



100% ELECTRICITY COMING
FROM RENEWABLE SOURCES

See pages 274-277 for a detailed explanation of the icons

MIX & MATCH



PERSONALIZED COLOURS



MANUFACTURED AND PRINTED IN BIC FACTORIES



MADE IN SPAIN



REGULATORY COMPLIANCE



WRITING MODES



BALLPEN M 0.1 MM

PRINTING TECHNIQUES



SCREEN PRINTING



DIGITAL

SUSTAINABILITY



IMPRIM'VERT®



FRUIT AND VEGETABLE TRAYS



100% ELECTRICITY COMING FROM RENEWABLE SOURCES

See pages 274-277 for a detailed explanation of the icons

ECO version and standard at the same price!

ecolutions®



MADE FROM 87% RECYCLED MATERIAL*

*Excluding ink system



FRUIT AND VEGETABLE TRAYS

1847

BIC® CLIC STIC STYLUS

1847 Opaque

Colour ink



Red Ink available under request



01

03

04

02

07

100%

1846

BIC® CLIC STIC STYLUS

1846 Opaque

Colour ink



Red Ink available under request



1E

3E

100%

*The percentage is calculated based on total weight of the pen excluding ink system. Due to the recycled content of the raw materials used to make the product, we cannot guarantee that the colours shown in the catalogue or colours customised to order will always have the same colour and appearance.

MIX & MATCH

No extra charge

MOQ 500 units. Standard colours combination

Plug

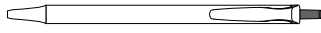

Opaque



Frosted

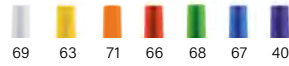

Clip



Opaque



Frosted

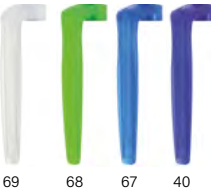

Section

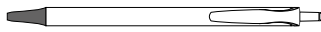

Opaque

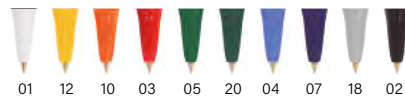

Frosted

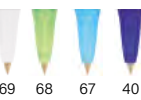

Stylus

Opaque



Barrel



Opaque

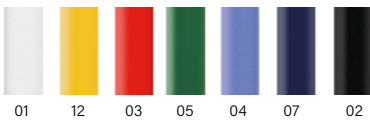

Stylus

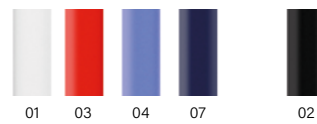

Softfeel®

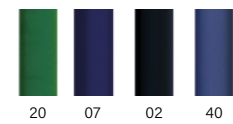

Frosted

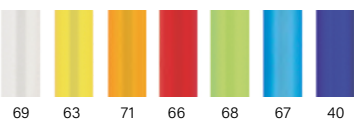

Exact colour match: ≥ 10.000 units

ecolutions®

MOQ 500 units
ecolutions® Standard colours combination**



*Excluding ink system

Add the Möbius loop to your artwork at no additional charge. Please specify it on your order. (Möbius loop imprint defaults to left-hand corner.)

FRUIT AND VEGETABLE TRAYS



Plug



Opaque



Section

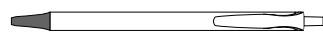

Opaque

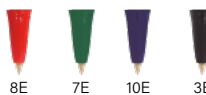

Stylus

Opaque



Clip



Opaque



Barrel



Opaque



Frosted



Stylus

Opaque



Exact colour match: ≥ 10.000 units

**Due to the recycled content of the raw materials used to make the product, we cannot guarantee that the colours shown in the catalogue or colours customised to order will always have the same colour and appearance.



PERSONALIZED COLOURS



MANUFACTURED AND PRINTED IN BIC FACTORIES



MADE IN SPAIN



REGULATORY COMPLIANCE



WRITING MODES



BALLPEN M 0.1 MM

PRINTING TECHNIQUES



SCREEN PRINTING



DIGITAL

SUSTAINABILITY



IMPRIM'VERT®



FRUIT AND VEGETABLE TRAYS



100% ELECTRICITY COMING FROM RENEWABLE SOURCES

1000 / 1E00 / 1847 / 1846

BIC® CLIC STIC

1000 / ecolutions® 1E00

BIC® CLIC STIC STYLUS

1847 / ecolutions® 1846

A SP: max. 3 col.

B SP: max. 1 col.

C SP: max. 2 col.

D DG: full-colour (area for text)
(Only available on white barrel)

MOQ 500 units.

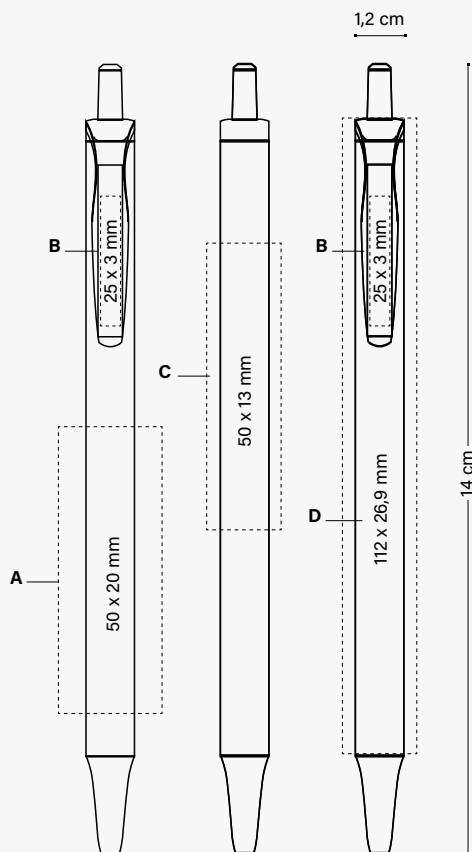

OPTIONAL SPECIAL PACKAGING



ECO SLEEVE



PLASTIC POUCH

+ INFO PAGES 262 TO 266

Can be used as bookmark

EXTERNAL PACKAGING



500 ± 2,9 KG

1005

BIC® CLIC STIC SOFTFEEL®
1005

A/B SP: max. 1 col.

MOQ 500 units.

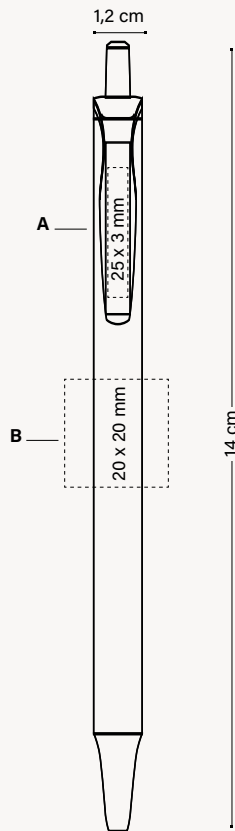

Decoration



PERSONALIZED COLOURS



MANUFACTURED AND PRINTED IN BIC FACTORIES



MADE IN SPAIN



REGULATORY COMPLIANCE



WRITING MODES



BALLPEN M
Ø 1 MM

PRINTING TECHNIQUES



SCREEN PRINTING



DIGITAL

SUSTAINABILITY



100% ELECTRICITY COMING FROM RENEWABLE SOURCES

OPTIONAL SPECIAL PACKAGING



ECO SLEEVE



PLASTIC POUCH



BIC COLLECTION BOX SLIM PENS

New!

+ INFO PAGES 262 TO 266

Can be used as bookmark

EXTERNAL PACKAGING



500 ± 2,9 KG

See pages 274-277 for a detailed explanation of the icons



Discover the eye-catching clip and its gentle twist mechanism. Large printing areas offer a wide range of personalisation possibilities in the standard and advance versions. Now also available in soft and glacé versions.

In addition, the BIC® Super Clip Origin, a more innovative and sustainable pen.

Welcome to the future!

FR

Découvrez le clip attrayant et son mécanisme pivotant silencieux. La grande zone d'impression XXL offre une vaste gamme de possibilités de personnalisation dans la version Standard et Advance. Également dans les versions Soft et Glacé.

De plus, le BIC® Super Clip Origin est le premier stylo d'une nouvelle étape plus innovatrice et durable.

Bienvenus dans le futur !

IT

Scopri l'accattivante clip e il suo fluido meccanismo twist. La grande area di stampa XXL offre un'ampia gamma di possibilità di personalizzazione nelle versioni standard e advance. Ora disponibile anche nelle versioni soft e glacé.

Inoltre, la BIC® Super Clip Origin è la prima penna a sfera di una nuova fase più innovativa e sostenibile.

Benvenuti nel futuro!

DE

Entdecken Sie den auffälligen Clip und seinen sanften Drehmechanismus. Der XXL-Druckbereich bietet vielseitige Personalisierungsmöglichkeiten bei der Standard und Advance-Version. Jetzt auch in Soft- und Glacé-Version.

Außerdem ist der BIC® Super Clip Origin der erste Kugelschreiber einer neuen innovativeren und nachhaltigeren Etappe.

Willkommen in der Zukunft!

ES

Descubre el llamativo clip y su mecanismo giratorio suave. La gran área de marcaje XXL ofrece una amplia variedad de posibilidades de personalización en la versión estándar y advance. Ahora también en las versiones soft y glacé.

Además, el BIC® Super Clip Origin es el primer bolígrafo de una nueva etapa más innovadora y sostenible.

¡Bienvenidos al futuro!



ECOLUTIONS®
ADVANCE
GLACÉ
GLACÉ ADVANCE
SOFT
SOFT ADVANCE
ORIGIN



1039

BIC® SUPER CLIP
1039 Opaque

Colour ink
● ●



Large
printing
areas!



Available on
white barrel



ECO version and standard at the same price!

ecolutions®

MADE FROM 90% RECYCLED MATERIAL*
*Excluding ink system

90%

PLASTIC CAR PARTS

1E50

BIC® SUPER CLIP
1E50 Opaque

Colour ink
● ●



1E

1039

BIC® SUPER CLIP
1039 Clear

Colour ink
● ●



51

87

86

89

88

MIX & MATCH



PERSONALIZED COLOURS



MANUFACTURED AND PRINTED IN BIC FACTORIES



MADE IN SPAIN



REGULATORY COMPLIANCE



ISO certified

WRITING MODES



BALLPEN M
Ø 1 MM

PRINTING TECHNIQUES



SCREEN PRINTING



DIGITAL



BRITEPIX™
BRITEPIX™ TEXTURE
BRITEPIX™ PERSONALISATION

SUSTAINABILITY



IMPRIM'VERT®

ecolutions®



PLASTIC CAR PARTS



100% ELECTRICITY COMING FROM RENEWABLE SOURCES

BIC GRAPHIC

BIC® WRITING INSTRUMENTS

OTHER WRITING INSTRUMENTS

NOTEBOOKS

BIC® / DLEEP® LIGHTERS AND BIC® CASES

BIC® PACKAGING

GENERAL INFORMATION

See pages 274-277 for a detailed explanation of the icons

*The percentage is calculated based on total weight of the pen excluding ink system. Due to the recycled content of the raw materials used to make the product, we cannot guarantee that the colours shown in the catalogue or colours customised to order will always have the same colour and appearance.

BIC® SUPER CLIP

1039 / 1E50

BIC® SUPER CLIP

1039 Opaque

ecolutions® 1E50 Opaque

1039 Clear

MOQ 250 units

Standard colours combination

MIX & MATCH

No extra charge

Clip

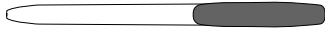

Opaque

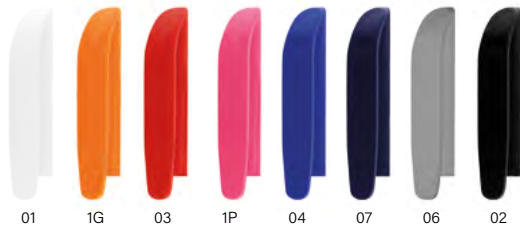

Clear

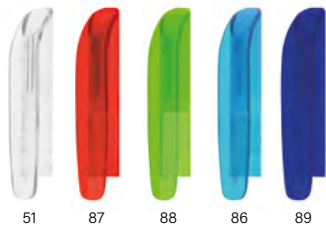

ecolutions®



Standard colours combination*



*Excluding ink system

Add the Möbius loop to your artwork at no additional charge. Please specify it on your order. (Möbius loop imprint defaults to left-hand hand corner.)

Barrel



Opaque

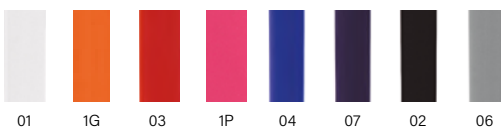

Clear

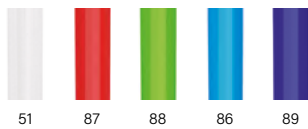

Exact colour match: ≥ 10.000 units



*Due to the recycled content of the raw materials used to make the product, we cannot guarantee that the colours shown in the catalogue or colours customised to order will always have the same colour and appearance.

1039 / 1E50

BIC® SUPER CLIP

1039

ecolutions® 1E50

A SP: max. 2 col.

B SP: max. 1 col.

C DG: full-colour

D BP: full-colour

BP Texture: full-colour

MOQ 250 units.

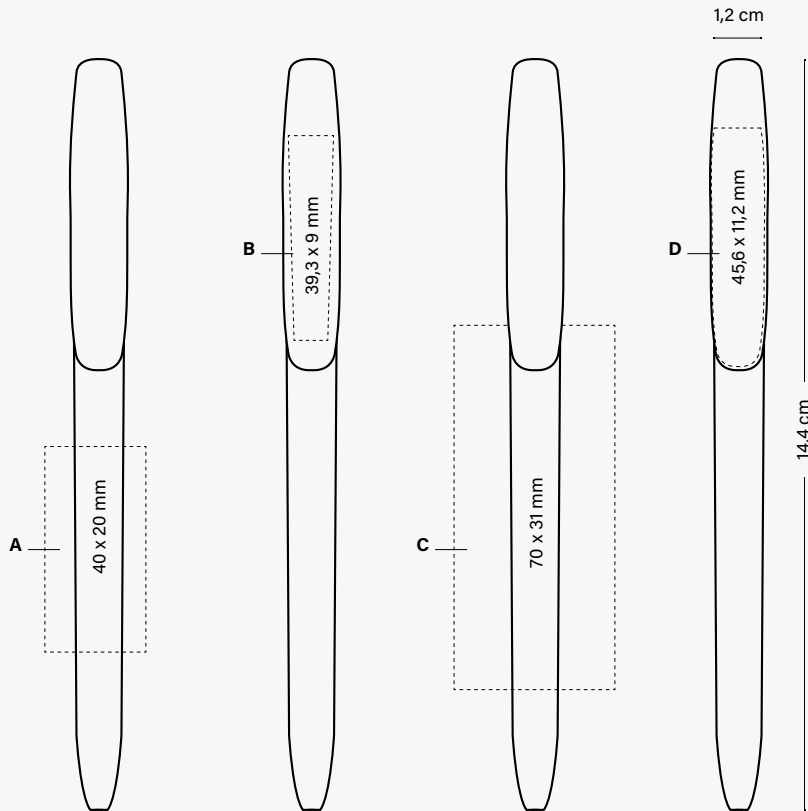

OPTIONAL SPECIAL PACKAGING



+ INFO PAGES 262 TO 266

Can be used as bookmark

Collection Box (1, 2 & 3 units)

EXTERNAL PACKAGING



250 ± 2,6 KG

Decoration



PERSONALIZED COLOURS



MANUFACTURED AND PRINTED IN BIC FACTORIES



MADE IN SPAIN



REGULATORY COMPLIANCE



ISO certified

WRITING MODES



BALLPEN M Ø 1 MM

PRINTING TECHNIQUES



SCREEN PRINTING



DIGITAL



BRITEPIX™
BRITEPIX™ TEXTURE
BRITEPIX™ PERSONALISATION

SUSTAINABILITY



IMPRIM'VERT®

ecolutions®



PLASTIC CAR PARTS



100% ELECTRICITY COMING FROM RENEWABLE SOURCES

See pages 274-277 for a detailed explanation of the icons

1073

BIC® SUPER CLIP ADVANCE

1073 Opaque

Colour ink





Available on white barrel



MIX & MATCH



PERSONALIZED COLOURS



MANUFACTURED AND PRINTED IN BIC FACTORIES



MADE IN SPAIN



REGULATORY COMPLIANCE



WRITING MODES



BALLPEN M Ø 1 MM

PRINTING TECHNIQUES



SCREEN PRINTING



DIGITAL



BRITEPIX™
BRITEPIX™ TEXTURE
BRITEPIX™ PERSONALISATION

SUSTAINABILITY



100% ELECTRICITY COMING FROM RENEWABLE SOURCES

BIC GRAPHIC

BIC® WRITING INSTRUMENTS

OTHER WRITING INSTRUMENTS

NOTEBOOKS

BIC® / DLEEP® LIGHTERS AND BIC® CASES

BIC® PACKAGING

GENERAL INFORMATION

See pages 274-277 for a detailed explanation of the icons

BIC® SUPER CLIP ADVANCE

1073

BIC® SUPER CLIP ADVANCE

1073 Opaque

MOQ 250 units
Standard colours combination

MIX & MATCH No extra charge

Clip

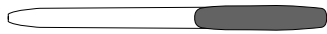

Opaque

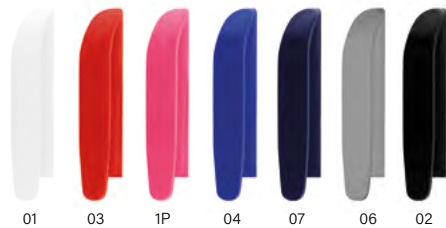

Barrel



Opaque

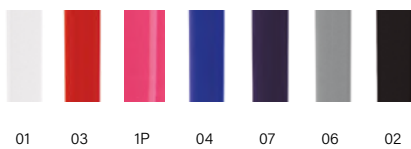

Section

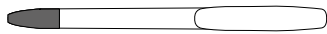

ADVANCE



35

Exact colour match: ≥ 10.000 units



1073

BIC® SUPER CLIP ADVANCE

1073

A SP: max. 2 col.

B SP: max. 1 col.

C DG: full-colour

D BP: full-colour

BP Texture: full-colour

MOQ 250 units.

Decoration

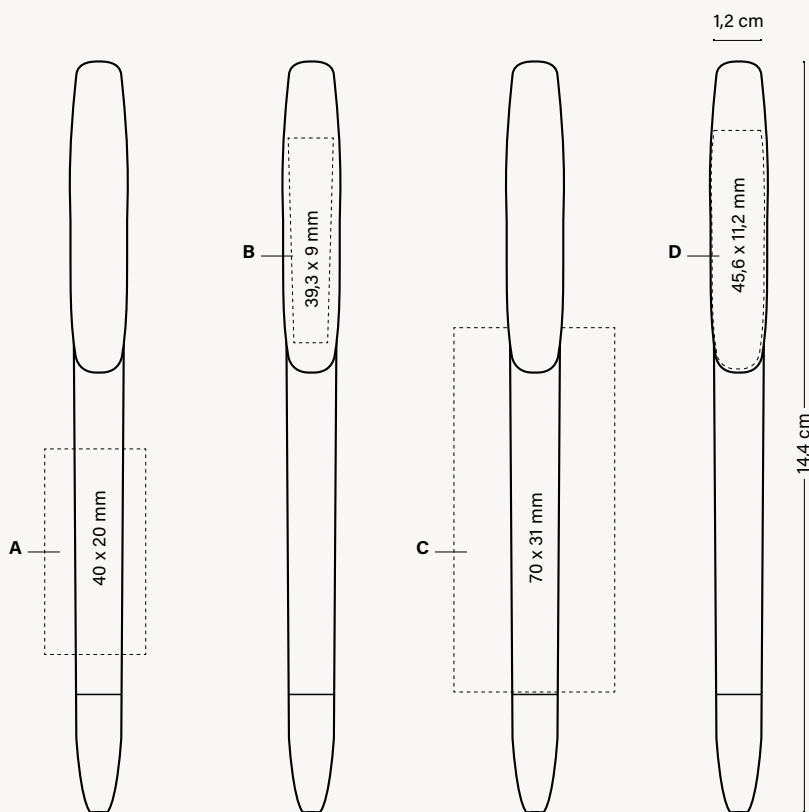

OPTIONAL SPECIAL PACKAGING



+ INFO PAGES 262 TO 266

Can be used as bookmark

Collection Box (1, 2 & 3 units)

EXTERNAL PACKAGING



250 ± 2,6 KG



WRITING MODES



PRINTING TECHNIQUES



SUSTAINABILITY

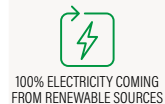

BIC GRAPHIC

BIC® WRITING INSTRUMENTS

OTHER WRITING INSTRUMENTS

NOTEBOOKS

BIC® / D/EEP® LIGHTERS AND BIC® CASES

BIC® PACKAGING

GENERAL INFORMATION

See pages 274-277 for a detailed explanation of the icons

BIC® SUPER CLIP GLACÉ

Discover the BIC® Super Clip in a glamorous version.

1082

BIC® SUPER CLIP GLACÉ
1082

Colour ink
● ●



1084

BIC® SUPER CLIP GLACÉ ADVANCE
1084

Colour ink
● ●



FR
Découvrez le
BIC® Super Clip
dans sa version
glamour.

DE
Entdecken Sie den
BIC® Super Clip in
der glamourösen
Version.

IT
Scopri la
BIC® Super Clip
nella sua versione
più glamour.

ES
Descubre el
BIC® Super Clip
en su versión
más glamurosa.

Section

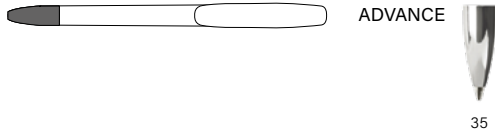

1082 / 1084

BIC® SUPER CLIP GLACÉ
1082

BIC® SUPER CLIP GLACÉ
ADVANCE
1084

A SP: max. 1 col.
B SP: max. 1 col.

MOQ 250 units
Standard colours combination

Decoration

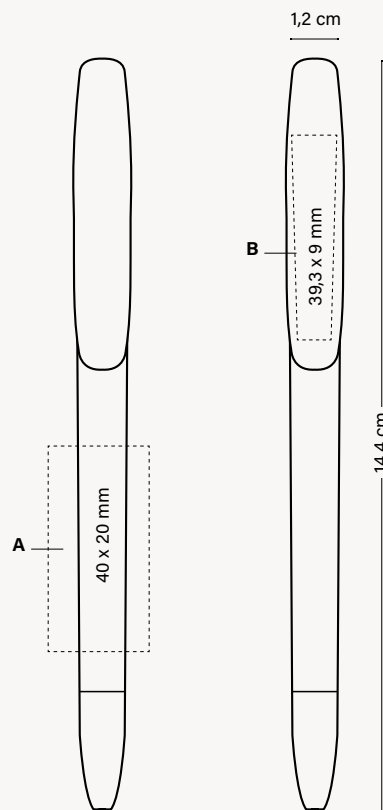

PERSONALIZED
COLOURS



MANUFACTURED
AND PRINTED IN
BIC FACTORIES



MADE
IN SPAIN



REGULATORY
COMPLIANCE



ISO
certified

WRITING
MODES



BALLPEN M
Ø 1 MM

PRINTING
TECHNIQUES



SCREEN PRINTING

SUSTAINABILITY



IMPRIM'VERT®



100% ELECTRICITY COMING
FROM RENEWABLE SOURCES

OPTIONAL SPECIAL PACKAGING



ECO
SLEEVE



PLASTIC
POUCH



WINDOW
BOX



COLLECTION
BOX

+ INFO PAGES 262 TO 266

*Can be used
as bookmark*

*Collection Box
(1, 2 & 3 units)*

EXTERNAL PACKAGING



250 ± 2,6 KG



CHECK OUT THE VIDEO

See pages 274-277 for a detailed explanation of the icons

BIC® SUPER CLIP SOFT & ADVANCE

Feel the incredible softness of our BIC® Super Clip version with twist mechanism.



1083

BIC® SUPER CLIP SOFT
1083

Colour ink
● ●



02F

03F

07F

100%

1085

**BIC® SUPER CLIP SOFT
ADVANCE**
1085

Colour ink
● ●



02F/35

03F/35

07F/35

100%



Refill
service on
request

FR
Découvrez
l'incroyable toucher
soyeux de notre
BIC® Super Clip
avec mécanisme de
rotation.

DE
Sie werden den
unglaublichen
Seidentouch unseres
BIC® Super Clip mit
Drehmechanismus zu
schätzen wissen.

IT
Apprezza l'incredibile
sensazione di setosità
della BIC® Super Clip.

ES
Aprecia el
increíble tacto de
seda de nuestro
BIC® Super Clip
con mecanismo
giratorio.

Section

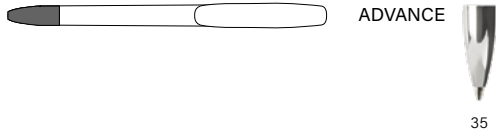

ADVANCE

35

1083 / 1085

BIC® SUPER CLIP SOFT
1083

BIC® SUPER CLIP SOFT
ADVANCE
1085

A SP: max. 1 col.

MOQ 250 units
Standard colours combination

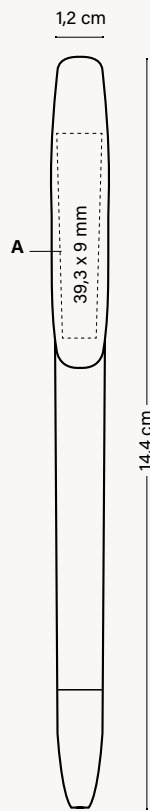

Decoration



WRITING
MODES

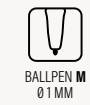

PRINTING
TECHNIQUES



SUSTAINABILITY



OPTIONAL SPECIAL PACKAGING



+ INFO PAGES 262 TO 266



*Can be used
as bookmark*

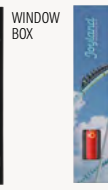

*Collection Box
(1, 2 & 3 units)*

EXTERNAL PACKAGING



250 ± 2,6 KG



CHECK OUT THE VIDEO

See pages 274-277 for a detailed explanation of the icons

BIC® SUPER CLIP ORIGIN

BIC® Super Clip Origin is made from natural ingredients*.

ORIGIN BIOBASED

FR

Le BIC® Super Clip Origin est fabriqué à partir de matériaux biosourcés composés de polymères naturels, à l'exclusion d'éléments provenant du pétrole et de combustibles fossiles*.

Fabriqué avec de l'huile de ricin et d'autres ingrédients d'origine végétale.*

Fabriqué et imprimé dans des usines alimentées avec **100% d'électricité d'énergie renouvelable**.

Corps et clip 100 % biosourcés.

IT

BIC® Super Clip Origin è realizzata in materiale biobased prodotto con ingredienti naturali, nessuno dei quali deriva da petrolio o combustibili fossili*.

Realizzata con olio di ricino e altri ingredienti di origine vegetale.*

Prodotto e stampato in stabilimenti alimentati al **100% da energia elettrica rinnovabile**.

Il fusto e la clip sono al 100% di origine biologica.

DE

BIC® Super Clip Origin besteht aus biobasiertem Material, das mit natürlichen Polymeren und ohne Erdöl oder fossile Brennstoffe hergestellt wird*.

Hergestellt mit **Rilsanöl** und anderen Materialien pflanzlichen Ursprungs.*

Hergestellt und bedruckt in Fabriken, die zu **100 % mit Strom aus erneuerbaren Quellen** betrieben werden.

Schaft und Clip sind zu 100 % biologischen Ursprungs.

ES

BIC® Super Clip Origin está hecho de material biológico fabricado con polímeros naturales que excluyen cualquier fuente de petróleo o combustibles fósiles*.

Elaborado con aceite Rilsan y otros ingredientes de origen vegetal.*

Fabricado e impreso en fábricas alimentadas con **electricidad 100% renovable**.

El cuerpo y el clip son 100 % de origen de material biológico.

* Refers to barrel and clip.

BIC® Super Clip Origin is made from biobased material manufactured with natural polymers excluding any source of petroleum or fossil fuels*.



Made with castor oil and other ingredients of vegetal origin.*



Manufactured and printed in factories 100% powered by **electricity produced using renewable sources.**



Barrel and clip are 100% biosourced.

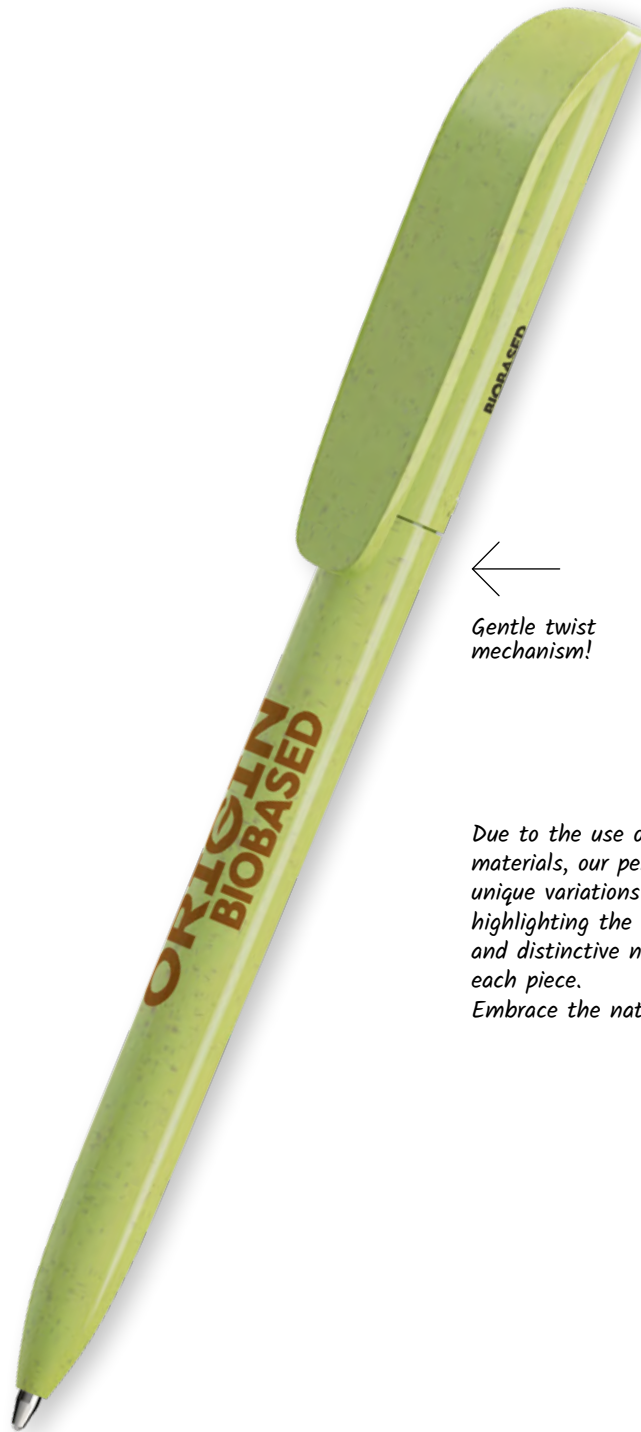

Gentle twist mechanism!

*Due to the use of natural materials, our pens feature unique variations in color, highlighting the authentic and distinctive nature of each piece.
Embrace the natural charm!*

6CO

* Refers to barrel and clip.

1038

BIC® SUPER CLIP ORIGIN

1038 Opaque

Colour ink



60

70

600

1038

BIC® SUPER CLIP ORIGIN

1038

A SP: max. 1 col.

MOQ 250 units
Standard colours combination

Decoration

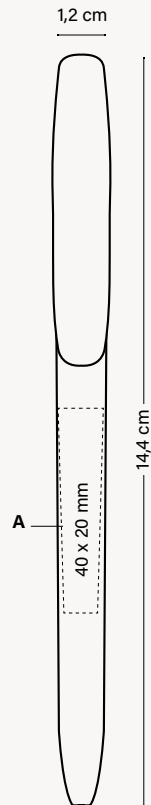

PERSONALIZED COLOURS



MANUFACTURED AND PRINTED IN BIC FACTORIES



MADE IN SPAIN



REGULATORY COMPLIANCE



ISO certified

PRINTING TECHNIQUES



SCREEN PRINTING

SUSTAINABILITY



IMPRIM'VERT®

ORIGIN BIOBASED



100% ELECTRICITY COMING FROM RENEWABLE SOURCES

OPTIONAL SPECIAL PACKAGING



ECO SLEEVE



PLASTIC POUCH



WINDOW BOX



COLLECTION BOX

+ INFO PAGES 262 TO 266

Can be used as bookmark

Collection Box (1, 2 & 3 units)

EXTERNAL PACKAGING



250 ± 2,6 KG



CHECK OUT THE VIDEO

See pages 274-277 for a detailed explanation of the icons

BIC® WIDE BODY™

The right size to show the true value of your brand!

Wide profile and wide variety of possibilities to maximise your message.



FR

La taille idéale pour mettre en valeur votre marque !

Corps large et multiples possibilités pour optimiser votre communication.

IT

La giusta misura per mostrare il vero valore del tuo marchio!

Ampio profilo e vasta gamma di possibilità per ottimizzare il tuo messaggio.

DE

Die richtige Größe, um den Wert Ihrer Marke widerzuspiegeln!

Breites Profil und eine Vielzahl von Möglichkeiten, Ihre Botschaft klar zu vermitteln.

ES

¡El tamaño ideal para enseñar el valor real de tu marca!

De perfil ancho y gran variedad de posibilidades para maximizar tu mensaje.

07

1080

BIC® WIDE BODY™
1080 Opaque

Colour ink
● ● ●

Red Ink available under request



Iconic BIC® Boy
is embossed



01 71 02 18



360°
Printing

100%

Available on
white barrel



1E80

BIC® WIDE BODY™
ecolutions® 1E80 Opaque

Colour ink
● ● ●

Red Ink available
under request



360°
Printing

100%

Available on
white barrel



ECO version and
standard at the same price!

ecolutions®



MADE FROM 98%
RECYCLED MATERIAL*
*From barrel



FRUIT AND
VEGETABLE TRAYS

**MIX &
MATCH**



PERSONALIZED
COLOURS



MANUFACTURED
AND PRINTED IN
BIC FACTORIES



MADE IN SPAIN



REGULATORY
COMPLIANCE



WRITING
MODES



BALLPEN M
0.1 MM

PRINTING
TECHNIQUES



SCREEN PRINTING



DIGITAL

SUSTAINABILITY



IMPRIM'VERT®

ecolutions®



FRUIT AND
VEGETABLE TRAYS



100% ELECTRICITY COMING
FROM RENEWABLE SOURCES

*The percentage is calculated based on total weight of the barrel. Due to the recycled content of the raw materials used to make the product, we cannot guarantee that the colours shown in the catalogue or colours customised to order will always have the same colour and appearance.

1080

BIC® WIDE BODY™
1080 Frosted

Colour ink
● ● ●



1893

BIC® WIDE BODY™
MINI DIGITAL
1893 Opaque

Colour ink
● ● ●

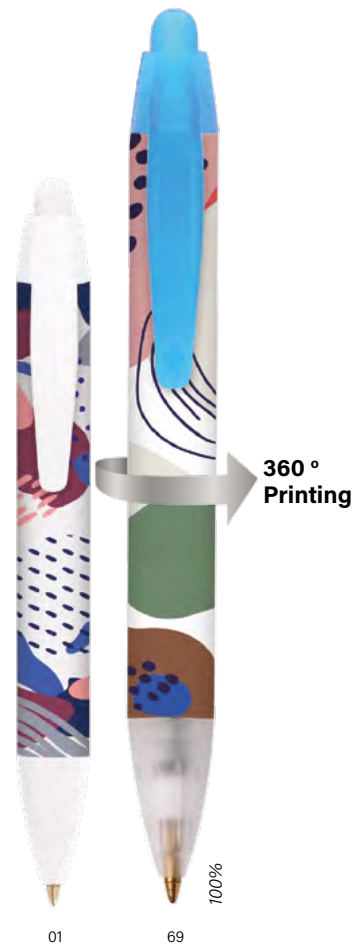

Available on
white barrel



1080 / 1E80 / 1893

MOQ 250 units
Standard colours combination

MIX & MATCH No extra charge

Plug



Opaque



Frosted



Clip



Opaque

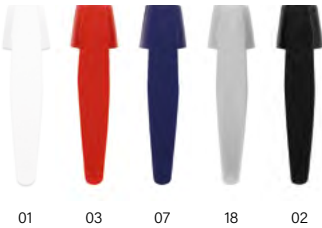

Frosted

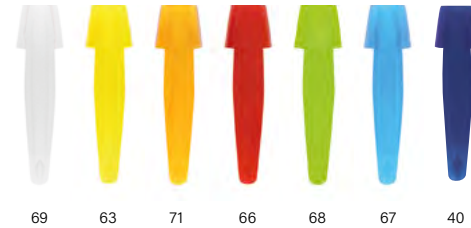

Barrel



Opaque



Frosted

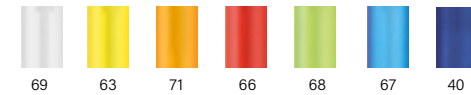

Opaque



ecolutions®*



Add the Möbius loop to your artwork at no additional charge. Please specify "Print the Möbius loop" on your order. (Möbius loop imprint defaults to left-hand corner.)

*From barrel



FRUIT AND VEGETABLE TRAYS

Section



Opaque

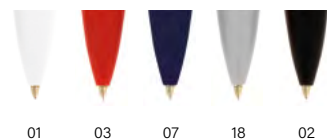

Frosted

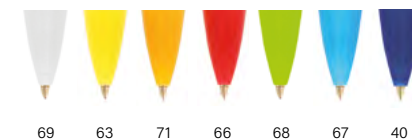

Exact colour match: ≥ 10.000 units



MIX & MATCH



PERSONALIZED COLOURS



MANUFACTURED AND PRINTED IN BIC FACTORIES



MADE IN SPAIN



REGULATORY COMPLIANCE



ISO certified

WRITING MODES



BALLPEN M 0.1 MM

PRINTING TECHNIQUES



SCREEN PRINTING



DIGITAL

SUSTAINABILITY



IMPRIM'VERT®

ecolutions®



FRUIT AND VEGETABLE TRAYS



100% ELECTRICITY COMING FROM RENEWABLE SOURCES

BIC GRAPHIC

BIC® WRITING INSTRUMENTS

OTHER WRITING INSTRUMENTS

NOTEBOOKS

BIC® / DLEEP® LIGHTERS AND BIC® CASES

BIC® PACKAGING

GENERAL INFORMATION

*Due to the recycled content of the raw materials used to make the product, we cannot guarantee that the colours shown in the catalogue or colours customised to order will always have the same colour and appearance.

1080 / 1E80

BIC® WIDE BODY™

1080 Opaque

ecolutions® 1E80

A/C SP: max. 2 col.

B/F SP: max. 1 col.

D DG: full-colour (area for images)

E DG: full-colour (area for text)

MOQ 250 units (SP)

MOQ 500 units (DG)

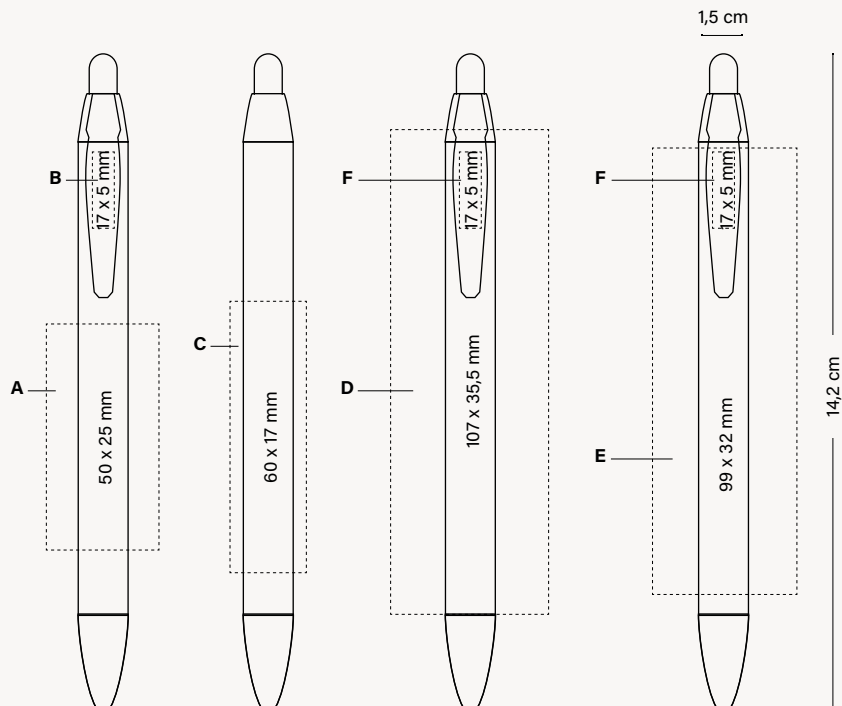

OPTIONAL SPECIAL PACKAGING



ECO SLEEVE



PLASTIC POUCH



WINDOW BOX



COLLECTION BOX

+ INFO PAGES 262 TO 266

Can be used as bookmark

Collection Box (1, 2 & 3 units)

EXTERNAL PACKAGING



250 ± 2,6KG

1893

**BIC® WIDE BODY™
MINI DIGITAL**

1893

A DG: full-colour (area for images)
B DG: full-colour (area for text)

MOQ 500 units (DG)

Decoration

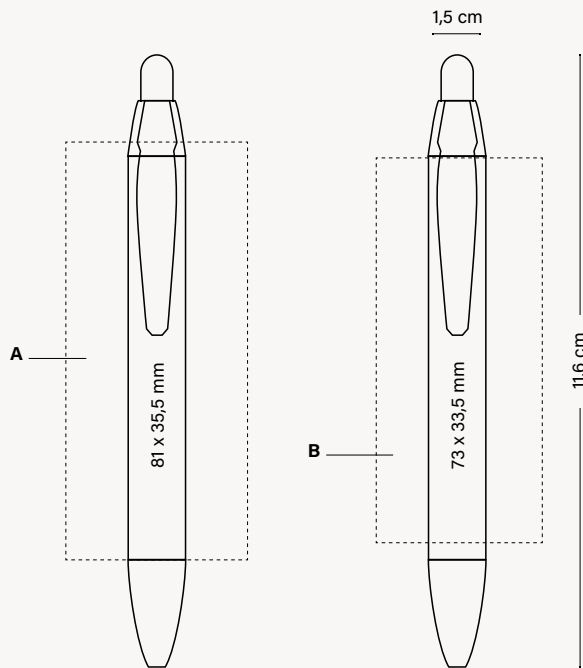

OPTIONAL SPECIAL PACKAGING



+ INFO PAGES 262 TO 266

*Can be used
as bookmark*

EXTERNAL PACKAGING



*Collection Box
(1, 2 & 3 units)*



PERSONALIZED COLOURS



MANUFACTURED AND PRINTED IN BIC FACTORIES



MADE IN SPAIN



REGULATORY COMPLIANCE



ISO certified

WRITING MODES



BALLPEN M 0.1 MM

PRINTING TECHNIQUES



SCREEN PRINTING



DIGITAL

SUSTAINABILITY



IMPRIM'VERT®

ecolutions®



FRUIT AND VEGETABLE TRAYS



100% ELECTRICITY COMING FROM RENEWABLE SOURCES

BIC® 4 COLOURS®

The world-renowned BIC® 4 Colours® ballpen gives you the convenience of four different ink colours in one ballpoint pen. For added convenience, it has a lanyard hole, so you can take it with you anywhere.

Discover all the versions: Classic, Fashion, Sun, Fine, Shine, Fluo, 3+1^{HB} (with mechanical pencil), Glacé, Soft, Wood Style and the latest versions Rainbow Decor, Pastel, Bicolor, Gradient and Flags Collection.

Don't wait...start your collection today!

FR

Le stylo à bille de renommée mondiale le BIC® 4 Couleurs® vous offre la commodité de quatre couleurs d'encre différentes dans un seul stylo à bille. Pour plus de confort, il est doté d'un anneau pour passer un cordon, vous pouvez donc l'emporter partout avec vous.

Découvrez toutes les différentes versions: Classic, Fashion, Sun, Fine, Shine, Fluo, 3+1^{HB} (avec porte-mine), Glacé, Soft, Wood Style et les dernières versions Rainbow Decor, Pastel, Bicolor, Gradient et Flags Collection.

Qu'attendez-vous pour commencer votre Collection ?

IT

BIC® 4 Colours® ti offre la comodità di quattro diversi colori di inchiostro in un'unica penna. Per una maggiore comodità, è dotata di un foro per un laccetto, così da portarla con te ovunque.

Scopri tutte le diverse versioni: Classic, Fashion, Sun, Fine, Shine, Fluo, Stylus, 3+1^{HB} (con portamine) Glacé, Soft, Wood Style e le ultimi versioni Rainbow Decor, Pastel, Bicolor, Gradient e Flags Collection.

Cosa aspetti a iniziare la tua collezione?

DE

Der weltbekannte BIC® 4 Colours® Kugelschreiber bietet Ihnen die Verwendung von vier verschiedenen Tintenfarben in einem Stift. Damit ist er eine ausgezeichnete Wahl für das Organisieren von Notizen oder Notieren von Daten in verschiedenen Farben. Dieser vielseitige Kugelschreiber hat eine Strichstärke von 1,0 mm und ist mit langlebiger Tinte ausgestattet. Für zusätzlichen Komfort können Sie ein Trage- oder Schlüsselband befestigen und ihn immer dabei haben.

Entdecken Sie alle Versionen: Classic, Sun, Fashion, Fine, Shine, Fluo, 3+1^{HB} (mit Druckbleistift), Glacé, Soft, Wood Style und die neuesten Versionen Rainbow Decor, Pastel, Bicolor, Gradient und Flags Collection.

Worauf warten Sie noch, um mit Ihrer Sammlung zu beginnen?

ES

El mundialmente reconocido bolígrafo BIC® 4 Colours® te ofrece la comodidad de cuatro colores de tinta diferentes en el mismo bolígrafo. Para una mayor comodidad, puedes colgarle un cordón, y llevarlo a cualquier parte.

Descubre todas las versiones: Classic, Sun, Fashion, Fine, Shine, Fluo, 3+1^{HB} (con portaminas), Glacé, Soft, Wood Style y las últimas versiones Rainbow Decor, Pastel, Bicolor, Gradient y Flags Collection.

¿A qué esperas para empezar tu colección?



RAINBOW DECOR
BICOLOR
GRADIENT
PASTEL
FASHION
SUN
FINE
FLUO
GLACÉ
SHINE
SOFT
WOOD STYLE
FLAGS COLLECTION
3+1^{HB}

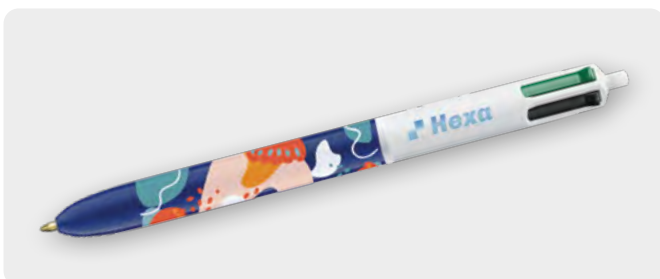

BIC® 4 COLOURS®

Always an icon.



THE SOLUTION
FOR FULL COLOUR
COMMUNICATION!

*Now in
coloured barrels*

1100 / 1101

BIC® 4 COLOURS®

1100 Opaque
1101 With lanyard

Colour ink
● ● ● ●



01/01

02/02

01/03

01/05

01/02

01/12

01/07

FR
Toujours une icône.

DE
Immer ein Kultmodell.

IT
Sempre un'icona.

ES
Siempre un icono.

1100 / 1101

BIC® 4 COLOURS®
1100/1101

- A SP:** max. 4 col.
- B DG:** Digital print (area for images)
- C BP:** full-colour
- D SP:** 1 col. (only for white upper parts)
- MOQ 250 units (SP, DG)
- MOQ 100 units (BP)

Decoration

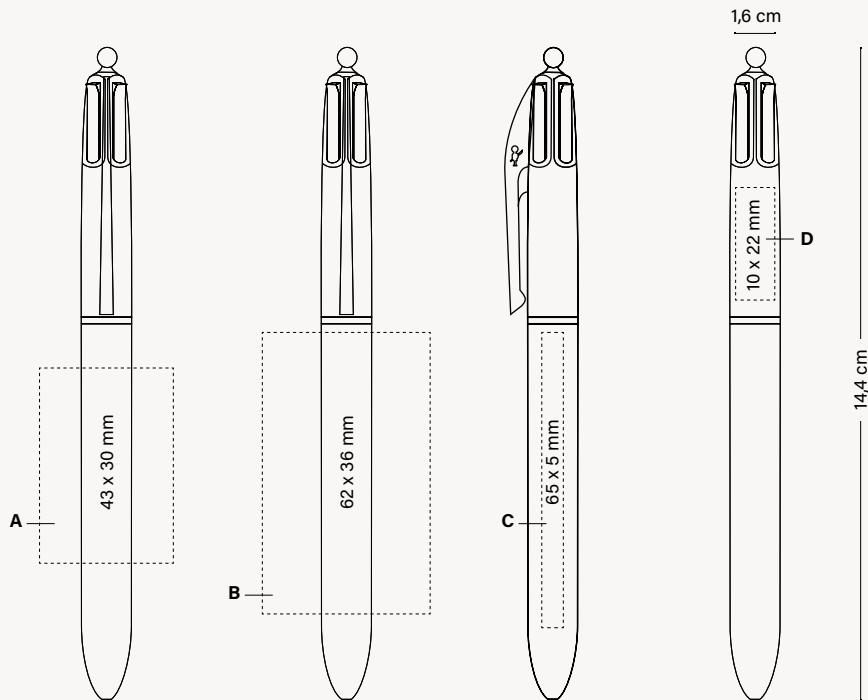

PERSONALIZED COLOURS



MANUFACTURED AND PRINTED IN BIC FACTORIES



MADE IN FRANCE



REGULATORY COMPLIANCE



ISO certified

WRITING MODES



BALLPEN M Ø 1 MM

PRINTING TECHNIQUES



SP SCREEN PRINTING



DG DIGITAL



BP BRITEPIX™

SUSTAINABILITY



IMPRIM'VERT®



100% ELECTRICITY COMING FROM RENEWABLE SOURCES

OPTIONAL SPECIAL PACKAGING



+ INFO PAGES 262 TO 266

Can be used as bookmark

Collection Box (1, 2 & 3 units)

EXTERNAL PACKAGING



250 ± 3,2KG

See pages 274-277 for a detailed explanation of the icons.

BIC GRAPHIC

BIC® WRITING INSTRUMENTS

OTHER WRITING INSTRUMENTS

NOTEBOOKS

BIC® / D/EEP® LIGHTERS AND BIC® CASES

BIC® PACKAGING

GENERAL INFORMATION

BIC® 4 COLOURS® RAINBOW DECOR

Colour Your World!

Your Life, Your Style

1123 / 1124

BIC® 4 COLOURS® RAINBOW DECOR

1123

1124 With Lanyard

Colour ink



NEW!

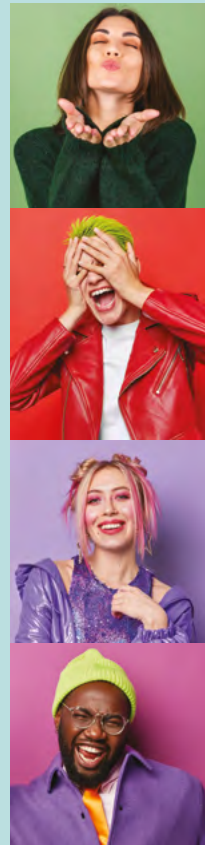

Refill
service on
request

01/9Y

FR

**Colorez votre
monde !**

Votre vie, votre style

DE

**Bringe Farbe
in deine Welt!**

Dein Leben, dein Stil

IT

**Colora il tuo
mondo!**

La tua vita, il tuo stile

ES

**¡Colorea
tu mundo!**

Tu vida, tu estilo

1123 / 1124

BIC® 4 COLOURS® RAINBOW DECOR
1123/1124

A SP: max. 2 col.
B SP: max. 1 col.

MOQ 250 units (SP)

Decoration

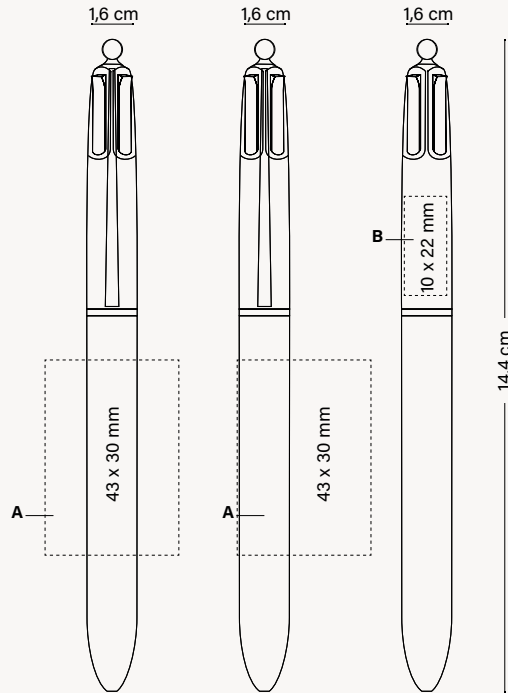

OPTIONAL SPECIAL PACKAGING



ECO SLEEVE

+ INFO PAGES 262 TO 266



PLASTIC POUCH

Can be used as bookmark



WINDOW BOX



COLLECTION BOX

Collection Box (1, 2 & 3 units)



250 ± 3,2KG

EXTERNAL PACKAGING



PERSONALIZED COLOURS



MANUFACTURED AND PRINTED IN BIC FACTORIES



FABRIQU  EN FRANCE
MADE IN FRANCE



REGULATORY COMPLIANCE



ISO certified

WRITING MODES



BALLPEN M
Ø 1 MM

PRINTING TECHNIQUES



SCREEN PRINTING

SUSTAINABILITY



IMPRIM'VERT®



100% ELECTRICITY COMING FROM RENEWABLE SOURCES



CHECK OUT THE VIDEO

See pages 274-277 for a detailed explanation of the icons.

BIC GRAPHIC

BIC® WRITING INSTRUMENTS

OTHER WRITING INSTRUMENTS

NOTEBOOKS

BIC® / DLEEP® LIGHTERS AND BIC® CASES

BIC® PACKAGING

GENERAL INFORMATION

BIC® 4 COLOURS® BICOLOR

Metallic aesthetics with an artistic touch.

1069 / 1076

BIC® 4 COLOURS® BICOLOR

1069

1076 With Lanyard

Colour ink



01/04G/47

01/05G/47

01/80/47

01/4R/47



Refill
service on
request

FR
Une esthétique
métallique avec une
touche artistique.

DE
Ein Metallic-Look mit
künstlerischer Note.

IT
Look metallico con
un tocco artistico.

ES
Estética metálica
con un toque
artístico.

1069 / 1076

BIC® 4 COLOURS® BICOLOR®
1069/1076

A SP: max. 2 col.
B SP: max. 1 col.

MOQ 250 units

Decoration

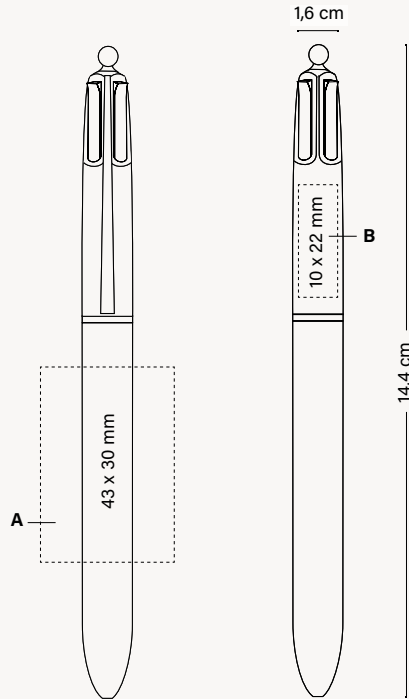

PERSONALIZED
COLOURS



MANUFACTURED
AND PRINTED IN
BIC FACTORIES



FABRIQUÉ
EN FRANCE
MADE IN FRANCE



REGULATORY
COMPLIANCE



ISO
certified

WRITING
MODES



BALLPEN M
Ø 1 MM

PRINTING
TECHNIQUES



SP
SCREEN PRINTING

SUSTAINABILITY



IMPRIM'VERT®



100% ELECTRICITY COMING
FROM RENEWABLE SOURCES

OPTIONAL SPECIAL PACKAGING



+ INFO PAGES 262 TO 266

*Can be used
as bookmark*

*Collection Box
(1, 2 & 3 units)*

EXTERNAL PACKAGING



250 ± 3,2KG



CHECK OUT THE VIDEO

See pages 274-277 for a detailed explanation of the icons.

BIC
GRAPHIC

BIC®
WRITING INSTRUMENTS

OTHER WRITING
INSTRUMENTS

NOTEBOOKS

BIC® / D'JEEP® LIGHTERS
AND BIC® CASES

BIC®
PACKAGING

GENERAL
INFORMATION

BIC® 4 COLOURS® GRADIENT

The most summery vibes.

1074 / 1075

BIC® 4 COLOURS® GRADIENT

1074

1075 With Lanyard

Colour ink



Refill
service on
request

01/3G/8D/4R

FR
**Un look
total d'été.**

DE
**Die beste
Sommer-Stimmung.**

IT
**Un'esplosione di
colori estivi.**

ES
**La vibraciones
más veraniegas.**

1074 / 1075

BIC® 4 COLOURS® GRADIENT

1074/1075

A SP: max. 2 col.

B SP: max. 1 col.

MOQ 250 units

Decoration

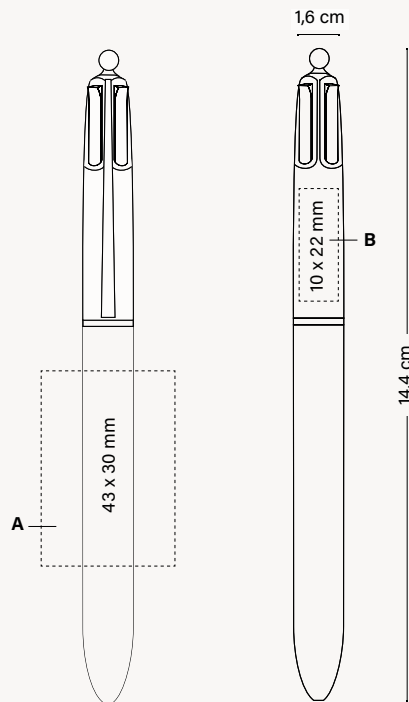

WRITING MODES



PRINTING TECHNIQUES



SUSTAINABILITY

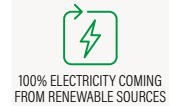

OPTIONAL SPECIAL PACKAGING



+ INFO PAGES 262 TO 266



Can be used as bookmark

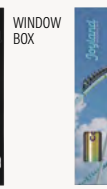

Collection Box (1, 2 & 3 units)

EXTERNAL PACKAGING



CHECK OUT THE VIDEO

See pages 274-277 for a detailed explanation of the icons.

BIC GRAPHIC

BIC® WRITING INSTRUMENTS

OTHER WRITING INSTRUMENTS

NOTEBOOKS

BIC® / DLEEP® LIGHTERS AND BIC® CASES

BIC® PACKAGING

GENERAL INFORMATION

BIC® 4 COLOURS® PASTEL

Vintage colours, dreamy imagery.

1071 / 1072

BIC® 4 COLOURS® PASTEL

1071 Opaque

1072 With Lanyard

Colour ink



Refill
service on
request

FR
**Des couleurs
vintages,
tout un rêve.**

DE
**Vintage-Farben,
eine verträumte
Bildsprache.**

IT
**Colori vintage,
immagini da
sogno.**

ES
**Colores vintage
de ensueño.**

1071 / 1072

BIC® 4 COLOURS® PASTEL

1071/1072

A SP: max. 4 col.
B DG: Digital print

MOQ 250 units

Decoration

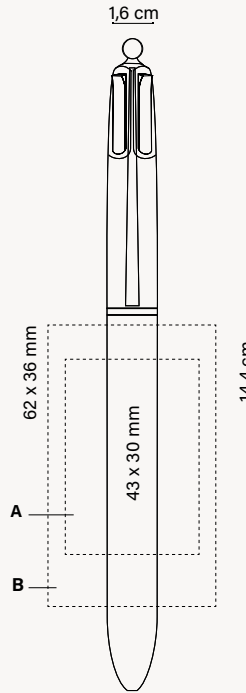

PERSONALIZED COLOURS



MANUFACTURED AND PRINTED IN BIC FACTORIES



MADE IN FRANCE



REGULATORY COMPLIANCE



WRITING MODES



BALLPEN M 0.1 MM

PRINTING TECHNIQUES



SCREEN PRINTING



DIGITAL

SUSTAINABILITY



IMPRIM'VERT®



100% ELECTRICITY COMING FROM RENEWABLE SOURCES

OPTIONAL SPECIAL PACKAGING

EXTERNAL PACKAGING



ECO SLEEVE

+ INFO PAGES 262 TO 266



PLASTIC POUCH

Can be used as bookmark



WINDOW BOX



COLLECTION BOX

Collection Box (1, 2 & 3 units)



250 ± 3,2KG



CHECK OUT THE VIDEO

See pages 274-277 for a detailed explanation of the icons.

BIC GRAPHIC

BIC® WRITING INSTRUMENTS

OTHER WRITING INSTRUMENTS

NOTEBOOKS

BIC® / DLEEP® LIGHTERS AND BIC® CASES

BIC® PACKAGING

GENERAL INFORMATION



THE SOLUTION FOR FULL COLOUR COMMUNICATION!

Now on coloured barrels

1102 / 1108

BIC® 4 COLOURS® FASHION

1102 Opaque

1108 With Lanyard

Colour ink



1102 / 1108

BIC® 4 COLOURS® FASHION
1102/1108

- A SP:** max. 4 col.
 - B DG:** Digital print (area for images)
 - C BP:** full-colour
 - D SP:** max. 1 col.
- MOQ 250 units (SP, DG)
MOQ 100 units (BP)

Decoration

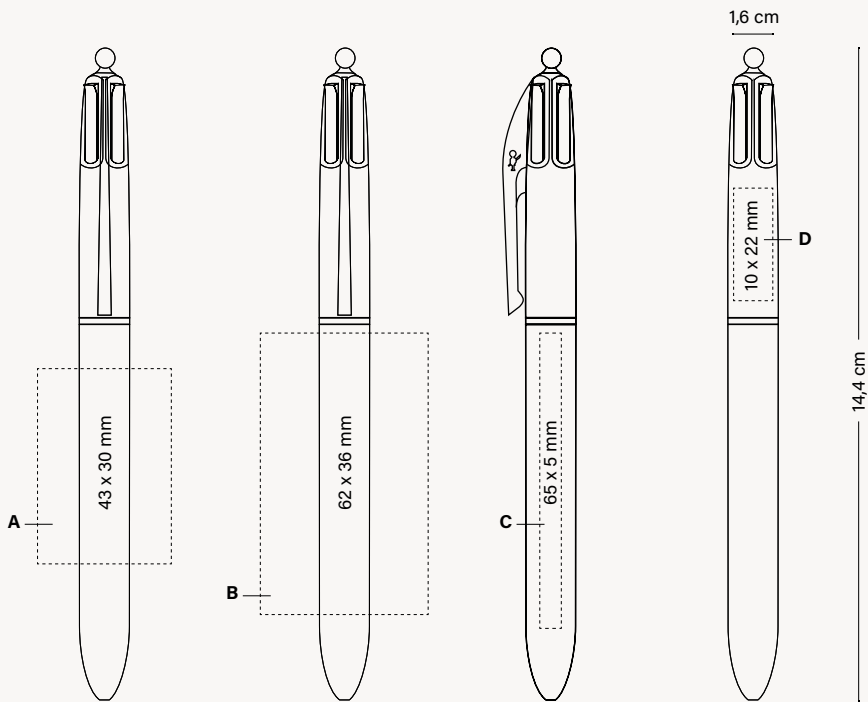

PERSONALIZED COLOURS



MANUFACTURED AND PRINTED IN BIC FACTORIES



MADE IN FRANCE



REGULATORY COMPLIANCE



ISO certified

WRITING MODES



BALLPEN M Ø 1 MM

PRINTING TECHNIQUES



SP
SCREEN PRINTING



BP
BRITEPIX™
BRITEPIX™ TEXTURE
BRITEPIX™ PERSONALISATION

SUSTAINABILITY



IMPRIM'VERT®



100% ELECTRICITY COMING FROM RENEWABLE SOURCES

OPTIONAL SPECIAL PACKAGING



ECO SLEEVE

+ INFO PAGES 262 TO 266



PLASTIC POUCH

Can be used as bookmark



WINDOW BOX



COLLECTION BOX

Collection Box (1, 2 & 3 units)



EXTERNAL PACKAGING

250 ± 3,2KG

See pages 274-277 for a detailed explanation of the icons.

BIC GRAPHIC

BIC® WRITING INSTRUMENTS

OTHER WRITING INSTRUMENTS

NOTEBOOKS

BIC® / DLEEP® LIGHTERS AND BIC® CASES

BIC® PACKAGING

GENERAL INFORMATION



THE SOLUTION
FOR FULL COLOUR
COMMUNICATION!

1097 / 1098

BIC® 4 COLOURS® SUN

1097 Opaque

1098 With Lanyard

Colour ink



*Flashy colours:
orange & yellow*



01/12

01/12

1097 / 1098

BIC® 4 COLOURS® SUN

1097/1098

A SP: max. 4 col.

B DG: Digital print (area for images)

C BP: full-colour

D SP: max. 1 col.

MOQ 250 units (SP, DG)

MOQ 100 units (BP)

Decoration

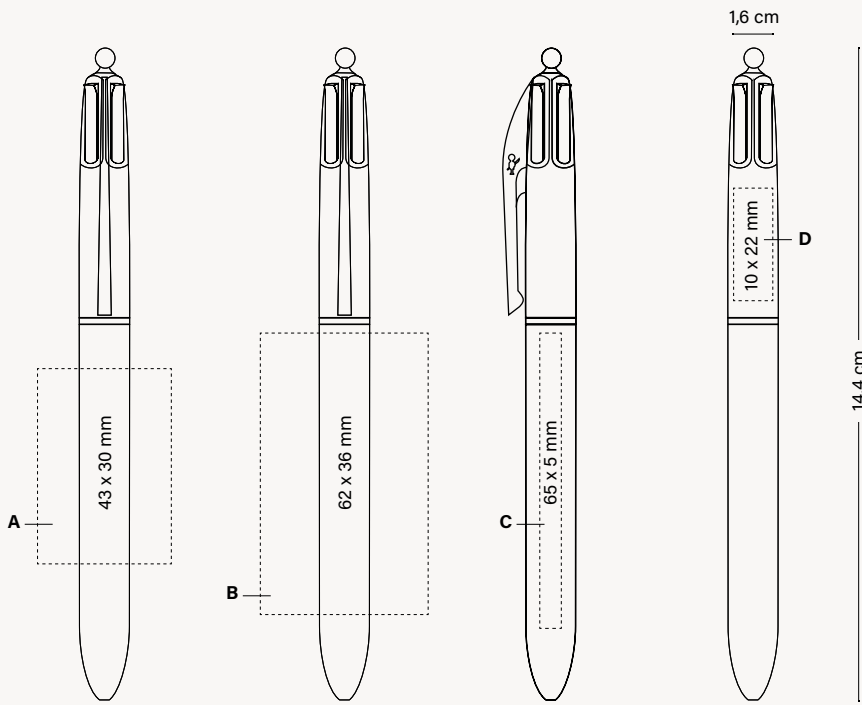

OPTIONAL SPECIAL PACKAGING



ECO SLEEVE

+ INFO PAGES 262 TO 266



PLASTIC POUCH

Can be used as bookmark



WINDOW BOX



COLLECTION BOX

Collection Box (1, 2 & 3 units)

EXTERNAL PACKAGING



250 ± 3,2KG



PERSONALIZED COLOURS



MANUFACTURED AND PRINTED IN BIC FACTORIES



MADE IN FRANCE



REGULATORY COMPLIANCE



WRITING MODES



BALLPEN M Ø 1 MM

PRINTING TECHNIQUES



SCREEN PRINTING



DIGITAL



BRITEPIX™
BRITEPIX™ TEXTURE
BRITEPIX™ PERSONALISATION

SUSTAINABILITY



IMPRIM'VERT®



100% ELECTRICITY COMING FROM RENEWABLE SOURCES

See pages 274-277 for a detailed explanation of the icons.

BIC GRAPHIC

BIC® WRITING INSTRUMENTS

OTHER WRITING INSTRUMENTS

NOTEBOOKS

BIC® / DLEEP® LIGHTERS AND BIC® CASES

BIC® PACKAGING

GENERAL INFORMATION

britePix
DIGITAL THE SOLUTION
FOR FULL COLOUR
COMMUNICATION!

1109 / 1111

BIC® 4 COLOURS® FINE

1109 Opaque
1111 With Lanyard

Colour ink
●●●●



1109 / 1111

BIC® 4 COLOURS® FINE

1109/1111

- A SP:** max. 4 col.
- B DG:** Digital print
- C BP:** full-colour
- D SP:** max. 1 col.

MOQ 250 units (SP, DG)
MOQ 100 units (BP)

Decoration

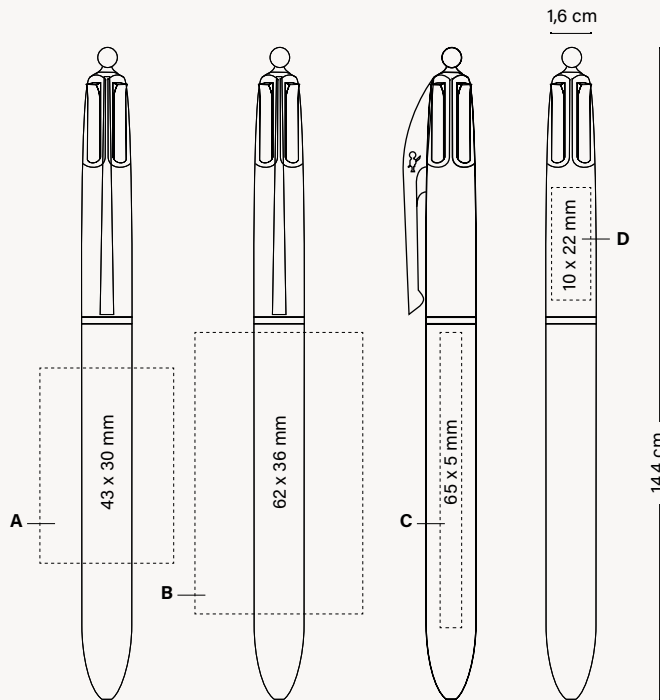

OPTIONAL SPECIAL PACKAGING



ECO SLEEVE

+ INFO PAGES 262 TO 266



PLASTIC POUCH

Can be used as bookmark



WINDOW BOX



COLLECTION BOX

Collection Box (1, 2 & 3 units)

EXTERNAL PACKAGING



250 ± 3,2KG



PERSONALIZED COLOURS



MANUFACTURED AND PRINTED IN BIC FACTORIES



MADE IN FRANCE



REGULATORY COMPLIANCE



WRITING MODES



BALLPEN M
Ø 0,8 MM

PRINTING TECHNIQUES



SCREEN PRINTING



DIGITAL



BRITEPIX™
BRITEPIX™ TEXTURE
BRITEPIX™ PERSONALISATION

SUSTAINABILITY



IMPRIM'VERT®



100% ELECTRICITY COMING FROM RENEWABLE SOURCES

See pages 274-277 for a detailed explanation of the icons.

1114 / 1116

BIC® 4 COLOURS® FLUO

1114 Opaque
1116 With Lanyard

Colour ink
●●●●

4 inks, one of them fluo!



01/4D

01/4D

100%

1114 / 1116

BIC® 4 COLOURS® FLUO

1114/1116

A SP: max. 4 col.

B BP: full-colour

C SP: max. 1 col.

MOQ 250 units (SP)

MOQ 100 units (BP)

Decoration

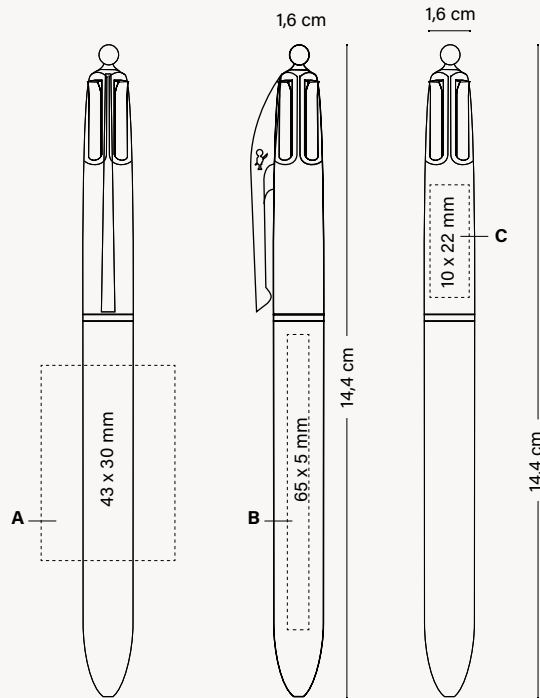

OPTIONAL SPECIAL PACKAGING



ECO SLEEVE



PLASTIC POUCH



WINDOW BOX



COLLECTION BOX

+ INFO PAGES 262 TO 266

Can be used as bookmark

Collection Box (1, 2 & 3 units)

EXTERNAL PACKAGING



250 ± 3,2KG



PERSONALIZED COLOURS



MANUFACTURED AND PRINTED IN BIC FACTORIES



MADE IN FRANCE



REGULATORY COMPLIANCE



WRITING MODES



BALLPEN M Ø 1 MM

PRINTING TECHNIQUES



SCREEN PRINTING



BRITEPIX™
BRITEPIX™ TEXTURE
BRITEPIX™ PERSONALISATION

SUSTAINABILITY



IMPRIM'VERT®



100% ELECTRICITY COMING FROM RENEWABLE SOURCES

See pages 274-277 for a detailed explanation of the icons.

BIC® 4 COLOURS® GLACÉ

Our classic pen dressed up.

1057 / 1058

BIC® 4 COLOURS® GLACÉ

1057

1058 With Lanyard

Colour ink



01/76

01/47G

01/03G

01/05G

01/04G

02/47G

02/76

01/14G



Refill
service on
request

FR

Notre stylo
classique dans
sa plus belle tenue

DE

Unser klassischer
Kugelschreiber
kleidet sich festlich

IT

La nostra penna
iconica in abito
elegante

ES

Nuestro bolígrafo
clásico se viste
de gala

1057 / 1058

BIC® 4 COLOURS® GLACÉ

1057/1058

A SP: max. 2 col.

B SP: max. 1 col. (only for white upper parts)

MOQ 250 units

Decoration

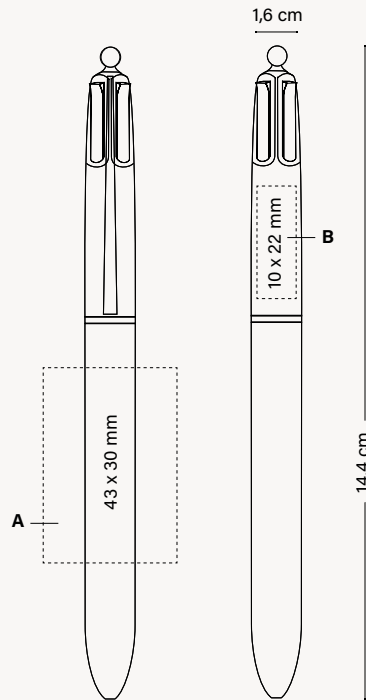

PERSONALIZED COLOURS



MANUFACTURED AND PRINTED IN BIC FACTORIES



FABRIQU  EN FRANCE
MADE IN FRANCE



REGULATORY COMPLIANCE



ISO certified

WRITING MODES



BALLPEN M
0.1 MM

PRINTING TECHNIQUES



SP
SCREEN PRINTING

SUSTAINABILITY



IMPRIM'VERT®



100% ELECTRICITY COMING FROM RENEWABLE SOURCES

OPTIONAL SPECIAL PACKAGING



ECO SLEEVE



PLASTIC POUCH



WINDOW BOX



COLLECTION BOX

+ INFO PAGES 262 TO 266

Can be used as bookmark

Collection Box (1, 2 & 3 units)

EXTERNAL PACKAGING



250 ± 3,2KG

See pages 274-277 for a detailed explanation of the icons.

BIC GRAPHIC

BIC WRITING INSTRUMENTS

OTHER WRITING INSTRUMENTS

NOTEBOOKS

BIC / DLEEP LIGHTERS AND BIC CASES

BIC PACKAGING

GENERAL INFORMATION

1106 / 1107

BIC® 4 COLOURS® SHINE

1106

1107 With Lanyard

Colour ink



01/75



01/26



01/7G



01/34



01/97

Super Shiny barrels!



Refill service on request

100%

1106 / 1107

BIC® 4 COLOURS® SHINE
1106/1107

A SP: max. 2 col.
B LE
C LE
D LE: 360°
E SP: max. 1 col.

MOQ 250 units

Decoration

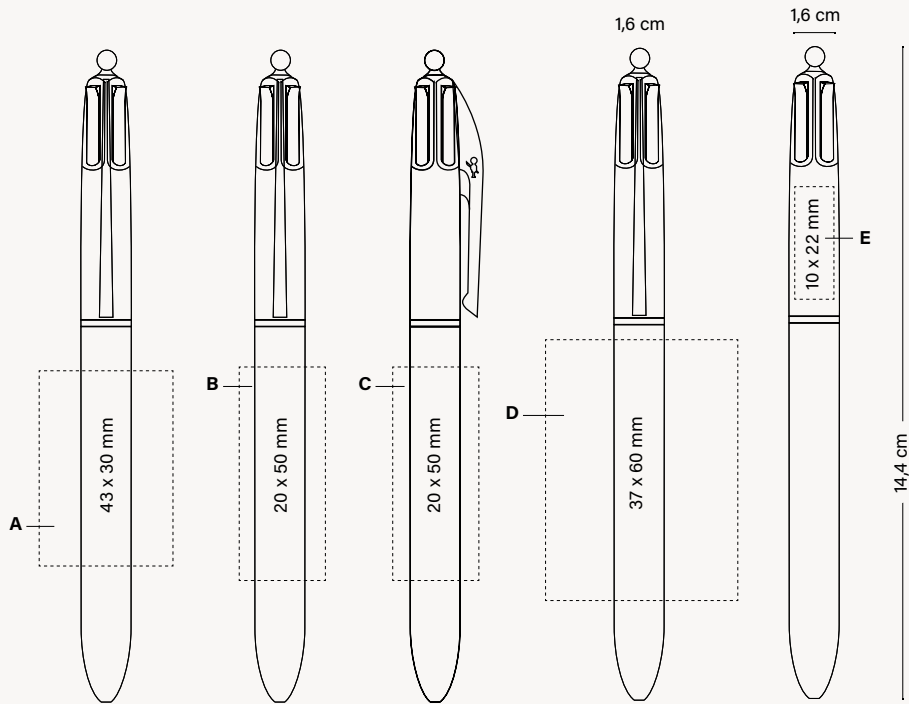

WRITING MODES



PRINTING TECHNIQUES



SUSTAINABILITY

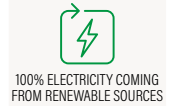

OPTIONAL SPECIAL PACKAGING



+ INFO PAGES 262 TO 266

Can be used as bookmark

EXTERNAL PACKAGING

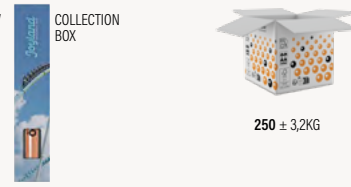

Collection Box (1, 2 & 3 units)



250 ± 3,2KG

See pages 274-277 for a detailed explanation of the icons.

BIC GRAPHIC

BIC® WRITING INSTRUMENTS

OTHER WRITING INSTRUMENTS

NOTEBOOKS

BIC® / D/EEP® LIGHTERS AND BIC® CASES

BIC® PACKAGING

GENERAL INFORMATION



BIC® 4 COLOURS® SOFT

A soft touch you won't want to put down!

1060 / 1063

BIC® 4 COLOURS® SOFT
1060 Opaque
1063 With Lanyard

Colour ink
● ● ● ●



*Feel the softness
in your hands*



Refill
service on
request

01/03F

01/02F

02/02F

01/07F

FR
**Un toucher doux
que vous ne
lâcherez plus !**

DE
**Ein sanftes Gefühl,
das Sie nicht mehr
aus der Hand
legen möchten.**

IT
**Una superficie
morbida che non
vorrai mai smettere
di toccare!**

ES
**¡Un tacto suave
que no querrás
dejar de tocar!**

1060 / 1063

BIC® 4 COLOURS® SOFT

1060/1063

A SP: max. 1 col.

B SP: max. 1 col. (only for white upper parts)

MOQ 250 units

Decoration

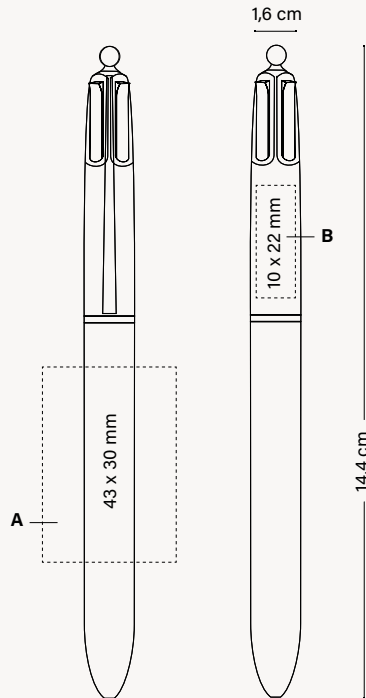

PERSONALIZED COLOURS



MANUFACTURED AND PRINTED IN BIC FACTORIES



FABRIQU  EN FRANCE
MADE IN FRANCE



REGULATORY COMPLIANCE



ISO certified

WRITING MODES



BALLPEN M
0.1 MM

PRINTING TECHNIQUES



SP
SCREEN PRINTING

SUSTAINABILITY



IMPRIM'VERT®



100% ELECTRICITY COMING FROM RENEWABLE SOURCES

OPTIONAL SPECIAL PACKAGING

EXTERNAL PACKAGING



ECO SLEEVE

+ INFO PAGES 262 TO 266



PLASTIC POUCH

Can be used as bookmark



WINDOW BOX



COLLECTION BOX

Collection Box (1, 2 & 3 units)



250 ± 3,2KG

See pages 274-277 for a detailed explanation of the icons.

BIC GRAPHIC

BIC® WRITING INSTRUMENTS

OTHER WRITING INSTRUMENTS

NOTEBOOKS

BIC® / DLEEP® LIGHTERS AND BIC® CASES

BIC® PACKAGING

GENERAL INFORMATION

BIC® 4 COLOURS® WOOD STYLE



Be impressed with the spectacular wood finish!

1061 / 1064

BIC® 4 COLOURS® WOOD STYLE

1061 Opaque

1064 With Lanyard

Colour ink



01/6AW

01/05W

01/02W

02/6AW

01/12W



Bring warmth to your brand



Refill service on request

FR
Laissez-vous impressionner par cette finition spectaculaire !

DE
Lassen Sie sich von der spektakulären Holzoptik beeindrucken!

IT
Lasciati impressionare dalla spettacolare finitura in legno!

ES
¡Déjate impresionar por el espectacular acabado efecto madera!

1061 / 1064

BIC® 4 COLOURS® WOOD STYLE

1061/1064

A SP: max. 2 col.

B SP: max. 1 col. (only for white upper parts)

MOQ 250 units

Decoration

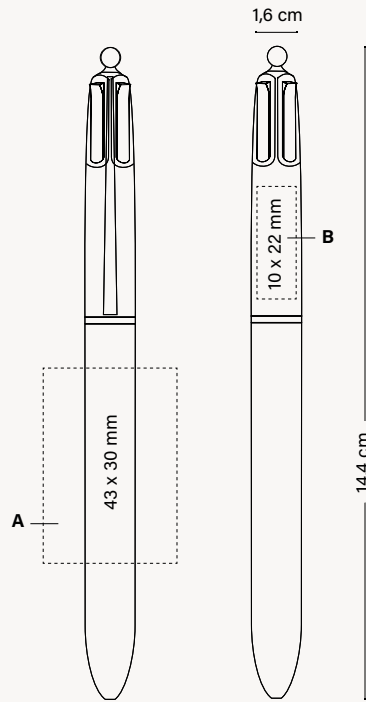

PERSONALIZED COLOURS



MANUFACTURED AND PRINTED IN BIC FACTORIES



MADE IN FRANCE



REGULATORY COMPLIANCE



WRITING MODES



BALLPEN M
Ø 1 MM

PRINTING TECHNIQUES



SCREEN PRINTING

SUSTAINABILITY



IMPRIM'VERT®



100% ELECTRICITY COMING FROM RENEWABLE SOURCES

OPTIONAL SPECIAL PACKAGING



ECO SLEEVE

+ INFO PAGES 262 TO 266



PLASTIC POUCH

Can be used as bookmark



WINDOW BOX



COLLECTION BOX

Collection Box (1, 2 & 3 units)

EXTERNAL PACKAGING



250 ± 3,2KG

See pages 274-277 for a detailed explanation of the icons.

BIC GRAPHIC

BIC® WRITING INSTRUMENTS

OTHER WRITING INSTRUMENTS

NOTEBOOKS

BIC® / DLEEP® LIGHTERS AND BIC® CASES

BIC® PACKAGING

GENERAL INFORMATION

BIC® 4 COLOURS® FLAGS COLLECTION

Celebrate heritage.

1067 / 1068

BIC® 4 COLOURS® FLAGS COLLECTION

1067

1068 With Lanyard

Colour ink



01/03/47/05



01/02/03/12



02/02/03/12



01/03/47/04



01/03/12/03



Refill
service on
request

FR
**Célébrer le
patrimoine !**

DE
**Feiern Sie Ihre
Geschichte!**

IT
**Celebra il
patrimonio!**

ES
**¡Celebra
el legado!**

1067 / 1068

BIC® 4 COLOURS® FLAGS COLLECTION

1067/1068

A SP: max. 2 col.

B SP: max. 1 col. (only for white upper parts)

MOQ 250 units

Decoration

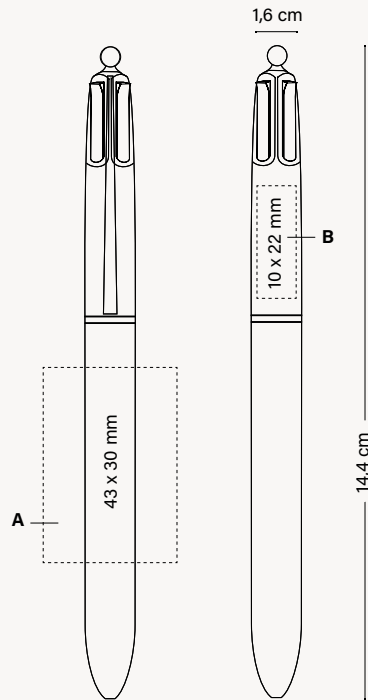

PERSONALIZED COLOURS



MANUFACTURED AND PRINTED IN BIC FACTORIES



MADE IN FRANCE



REGULATORY COMPLIANCE



WRITING MODES



BALLPEN M
Ø 1 MM

PRINTING TECHNIQUES



SCREEN PRINTING

SUSTAINABILITY



IMPRIM'VERT®



100% ELECTRICITY COMING FROM RENEWABLE SOURCES

OPTIONAL SPECIAL PACKAGING



ECO SLEEVE



PLASTIC POUCH



WINDOW BOX



COLLECTION BOX

+ INFO PAGES 262 TO 266

Can be used as bookmark

Collection Box (1, 2 & 3 units)

EXTERNAL PACKAGING



250 ± 3,2KG



CHECK OUT THE VIDEO

See pages 274-277 for a detailed explanation of the icons.

1099

BIC® 4 COLOURS® 3+1^{HB}
1099 Opaque

Colour ink
●●●●



3 ballpens +
1 mechanical pencil.



Refill
service on
request



1099

BIC® 4 COLOURS® 3+1^{HB}

1099 Opaque

A/B LE

MOQ 250 units

Decoration

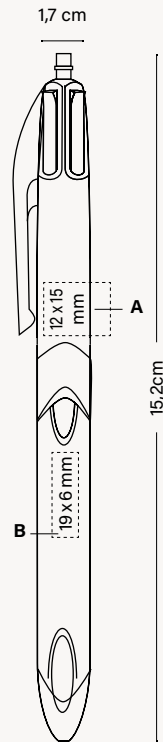

PERSONALIZED COLOURS



MANUFACTURED AND PRINTED IN BIC FACTORIES



REGULATORY COMPLIANCE



WRITING MODES



BALLPEN M
Ø 1 MM



MECHANICAL PENCIL
MP Ø 0,7MM

PRINTING TECHNIQUES



LASER

SUSTAINABILITY



IMPRIM'VERT®



100% ELECTRICITY COMING FROM RENEWABLE SOURCES

OPTIONAL SPECIAL PACKAGING



PLASTIC POUCH

+ INFO PAGES 262 TO 266

Can be used as bookmark



COLLECTION BOX

Collection Box (1, 2 & 3 units)

EXTERNAL PACKAGING



250 ± 3,5 KG



CHECK OUT THE VIDEO

See pages 274-277 for a detailed explanation of the icons.

BIC GRAPHIC

BIC® WRITING INSTRUMENTS

OTHER WRITING INSTRUMENTS

NOTEBOOKS

BIC® / DLEEP® LIGHTERS AND BIC® CASES

BIC® PACKAGING

GENERAL INFORMATION

BIC® METAL PRO

Metal accents and modern design, available in classic colors and a variety of finishes.

1290

BIC® METAL PRO

1290 Soft

Colour ink



01F



02F



04F



Maximum writing comfort



German ink for writing up to 8 km.

FR

Des accents métalliques et un design moderne, disponible en couleurs classiques et une variété de finitions.

DE

Metallakzente und modernes Design, erhältlich in klassischen Farben und einer Vielzahl von Ausführungen.

IT

Particolari metallici, design moderno, disponibili in colori classici e una varietà di finiture.

ES

Detalles metálicos y diseño moderno, disponible en colores clásicos y una variedad de acabados.

1290

BIC® METAL PRO
1290 Polished

Colour ink
● ●



01E



02E



04E

100%

ASSEMBLED
AND PRINTED IN
BIC FACTORIES

MADE IN EUROPE

REGULATORY
COMPLIANCE

ISO
certified

**WRITING
MODES**

BALLPEN M
Ø 1 MM

**PRINTING
TECHNIQUES**

SP
SCREEN PRINTING

LE
LASER

SUSTAINABILITY

IMPRIM'VERT®

See pages 274-277 for a detailed explanation of the icons

1290

BIC® METAL PRO

1290 Matt

Colour ink



01D



02D



04D

100%

1290

BIC® METAL PRO

1290

A SP: max. 2 col.
(Not available in soft finish)

B LE/SP: max. 1 col.

C LE 360°

MOQ 50 units

Decoration



WRITING MODES



PRINTING TECHNIQUES



SUSTAINABILITY

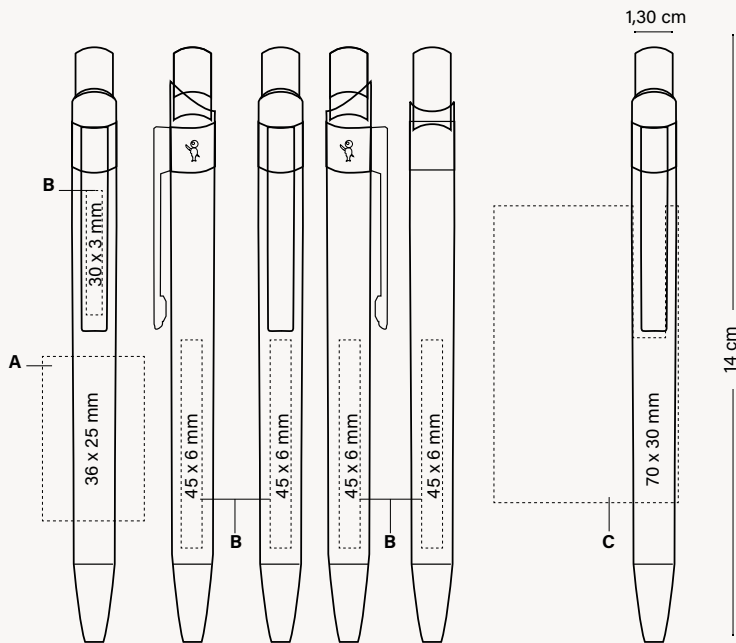

OPTIONAL SPECIAL PACKAGING



+ INFO PAGES 262 TO 266

EXTERNAL PACKAGING



See pages 274-277 for a detailed explanation of the icons

BIC GRAPHIC

BIC® WRITING INSTRUMENTS

OTHER WRITING INSTRUMENTS

NOTEBOOKS

BIC® / DLEEP® LIGHTERS AND BIC® CASES

BIC® PACKAGING

GENERAL INFORMATION

BIC® ROLLERS AND GELS

Enjoy a smooth writing experience. Glide across the paper easily without smudging thanks to the quick-drying ink, ideal for both left and right-handed people.

FR

Profitez d'une expérience d'écriture douce, fluide et de longue durée. Parfait pour les droitiers comme pour les gauchers, il glisse facilement sur le papier et ne fait pas de tâches grâce à son encre à séchage rapide.

DE

Genießen Sie das sanfte Schreiberlebnis. Gleitet leicht über das Papier und dank der schnell trocknenden Tinte, ohne zu verschmieren. Ideal für Links- und Rechtshänder.

IT

Goditi un'esperienza di scrittura morbidissima. Scorre facilmente sulla carta senza macchiare grazie all' inchiostro ad asciugatura immediata, ideale per mancini.

ES

Disfruta de una experiencia de escritura suave, fluida y de larga duración. Se desliza fácilmente a través del papel y sin manchas gracias a la tinta de secado rápido, ideal tanto para las personas zurdas como diestras.



BIC® GRIP ROLLER
BIC® XS FINESTYLE
BIC® INTENSITY® GEL CLIC



BIC® GRIP ROLLER

1187



MEDIUM WRITING
Ø 0,7 MM

High quality medium point liquid ink roller pen for smooth and fluid writing

BIC® GRIP ROLLER

1187

Colour ink



100%

01/35

12/35

10/35

03/35

59/35

24/35

07/35

06/35

27/35

02/35

14/35

●
Also available
in blue ink

●
Also available
in blue ink

●
Also available
in blue ink

1187

BIC® GRIP ROLLER

1187

A/B SP: max. 3 col.

MOQ 250 units

Decoration

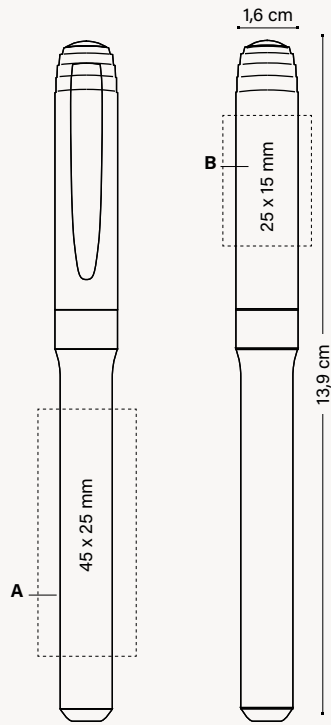

OPTIONAL SPECIAL PACKAGING



+ INFO PAGES 262 TO 266



Can be used as bookmark

Collection Box (1, 2 & 3 units)

EXTERNAL PACKAGING



250 ± 3 KG

1851

BIC® XS FINESTYLE
1851 Opaque

Colour ink
●



01/03



01/25



01/06

●
Only available
in black ink

1851

BIC® XS FINESTYLE
1851 Clear

Colour ink
●



89/01

100%

1851

BIC® XS FINESTYLE

1851

A PD: max. 2 col.

B SP: max. 2 col.

C BP: full-colour

MOQ 250 units

Decoration

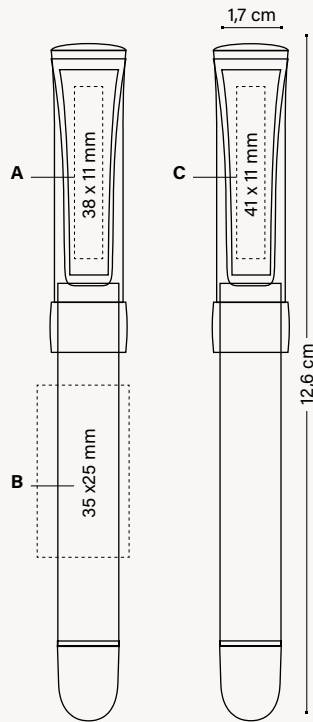

WRITING MODES



PRINTING TECHNIQUES



SUSTAINABILITY



OPTIONAL SPECIAL PACKAGING



ECO SLEEVE



PLASTIC POUCH

+ INFO PAGES 262 TO 266

Can be used as bookmark

EXTERNAL PACKAGING



250 ± 2,8KG

BIC GRAPHIC

BIC® WRITING INSTRUMENTS

OTHER WRITING INSTRUMENTS

NOTEBOOKS

BIC® / D/DEEP® LIGHTERS AND BIC® CASES

BIC® PACKAGING

GENERAL INFORMATION

See pages 274-277 for a detailed explanation of the icons

1196



*Iconic BIC® Boy
is embossed*

**BIC® INTENSITY®
GEL CLIC**

1196 Opaque

Colour ink



01



02

100%

1196

**BIC® INTENSITY®
GEL CLIC**

1196 Clear

Colour ink



92



88



86

100%

1196

BIC® INTENSITY® GEL CLIC

1196

A SP: max. 2 col.

B SP: max. 4 col.

MOQ 250 units

Decoration



MANUFACTURED AND PRINTED IN BIC FACTORIES



REGULATORY COMPLIANCE



WRITING MODES



GEL G
0,7 MM

PRINTING TECHNIQUES



SCREEN PRINTING

SUSTAINABILITY



IMPRIM'VERT®

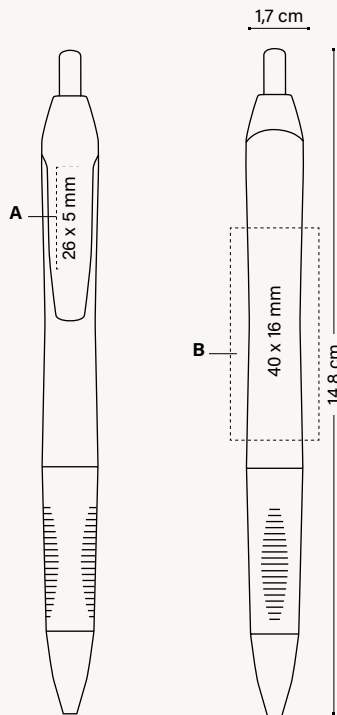

OPTIONAL SPECIAL PACKAGING



PLASTIC POUCH

+ INFO PAGES 262 TO 266

EXTERNAL PACKAGING



250 ± 3,7KG

See pages 274-277 for a detailed explanation of the icons

BIC® HIGHLIGHTERS AND MARKERS

BIC® Markers offer you products specifically designed to write in a highly visible way and mark on surfaces or material that other writing instruments cannot mark on. Make your ideas visible and express yourself whatever the surface with BIC® Markers.

FR

Les surligneurs et les marqueurs BIC® ont été conçus pour écrire d'une manière visible sur une large gamme de surfaces. Exprimez-vous avec clarté sur n'importe quelle surface.

DE

BIC®-Textmarker sind Produkte, die speziell konzipiert wurden, um besonders sichtbar zu schreiben und auf Oberflächen oder Materialien zu markieren, wo herkömmliche Schreibgeräte möglicherweise an ihre Grenzen stoßen.

IT

BIC® ti offre prodotti appositamente progettati per scrivere in modo ben visibile su superfici e materiali su cui altri strumenti di scrittura non possono scrivere. Rendi visibili le tue idee ed esprimiti su qualsiasi superficie con pennarelli BIC®.

ES

Los resaltadores y marcadores BIC® están diseñados para escribir visiblemente en un amplio rango de superficies. Exprésate con claridad sin importar la superficie.



- BIC® BRITE LINER® GRIP**
- BIC® VELLEDA® WHITE BOARD MARKER FINE**
- BIC® VELLEDA® WHITE BOARD MARKER GRIP**
- BIC® MARK-IT PERMANENT MARKER**
- BIC® PERMANENT MARKER ECOLUTIONS®**



1192

BIC® BRITE LINER® GRIP
1192



*Textured rubberised grip for
more precision and control*

12



Colour ink

10



Colour ink

24



Colour ink

59



Colour ink

14



Colour ink

100%

1192

BIC® BRITE LINER® GRIP

1192

A/B SP: max. 3 col.

MOQ 250 units

Decoration

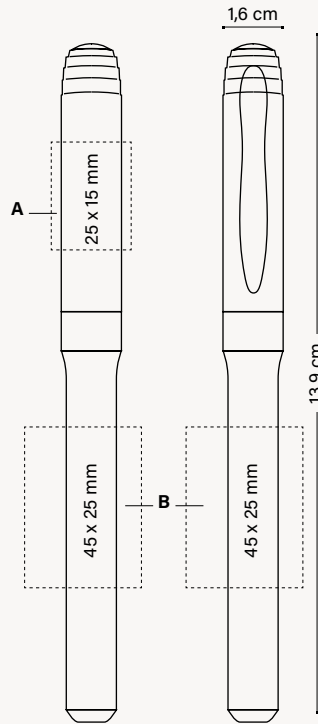

OPTIONAL SPECIAL PACKAGING



MARKING SET



Collection Box (1, 2 & 3 units)

+ INFO PAGES 262 TO 266

Can be used as bookmark

EXTERNAL PACKAGING



WILL NOT DRY OUT IN 24H



HIGHLIGHTER HL



SCREEN PRINTING



PHOTOCOPIES



PRINTERS



PAPER

SUSTAINABILITY



IMPRIM'VERT®

BIC GRAPHIC

BIC® WRITING INSTRUMENTS

OTHER WRITING INSTRUMENTS

NOTEBOOKS

BIC® / D'JEEP® LIGHTERS AND BIC® CASES

BIC® PACKAGING

GENERAL INFORMATION

See pages 274-277 for a detailed explanation of the icons

BIC® VELLEDA® WHITE BOARD MARKER FINE

Velleda®

Decoration

1651

BIC® VELLEDA® WHITE BOARD MARKER FINE
1651



01/04

●
Colour ink



01/02

●
Colour ink

100%

1651

BIC® VELLEDA® WHITE BOARD MARKER FINE
1651

A SP: max. 1 col.

MOQ 500 units

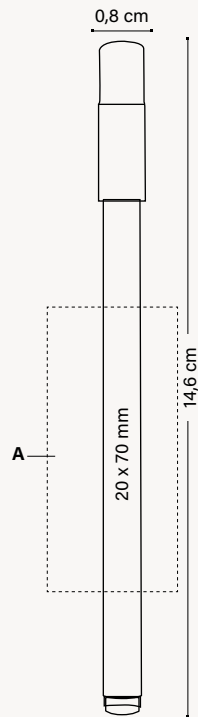

OPTIONAL SPECIAL PACKAGING



MARKING SET

Now you can have it as a set!

+ INFO PAGES 262 TO 266

EXTERNAL PACKAGING



500 ± 3,2KG



MANUFACTURED AND PRINTED IN BIC FACTORIES

FABRIQUÉ EN FRANCE  MADE IN FRANCE



REGULATORY COMPLIANCE



RESISTANT TIP



WRITING MODES



MARKER MK

PRINTING TECHNIQUES



SCREEN PRINTING

SUSTAINABILITY



BIC® VELLEDA® WHITE BOARD MARKER GRIP



Decoration

1213

BIC® VELLEDA® WHITE BOARD MARKER GRIP

1213

A/B SP: max. 3 col.

MOQ 250 units

1213

BIC® VELLEDA® WHITE BOARD MARKER GRIP

1213



Textured rubberised grip for more precision and control

100%

01/02

Colour ink

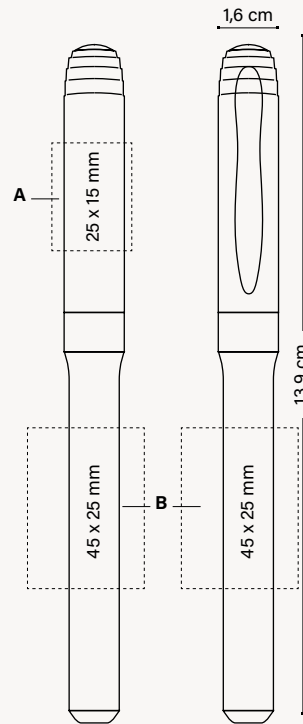

OPTIONAL SPECIAL PACKAGING



MARKING SET

+ INFO PAGES 262 TO 266

Can be used as bookmark

EXTERNAL PACKAGING



250 ± 2,7KG

Now you can have it as a set!



MANUFACTURED AND PRINTED IN BIC FACTORIES



REGULATORY COMPLIANCE



RESISTANT TIP

WRITING MODES



MARKER MK

PRINTING TECHNIQUES



SCREEN PRINTING

SUSTAINABILITY



BIC® MARK-IT PERMANENT MARKER

Decoration

1214

**BIC® MARK-IT
PERMANENT
MARKER**
1214



01/02

●
Colour ink

01/04

●
Colour ink

100%

←
*Textured rubberised
grip for more
precision and control*

1214

**BIC® MARK-IT
PERMANENT MARKER**
1214

A/B SP: max. 3 col.

MOQ 250 units

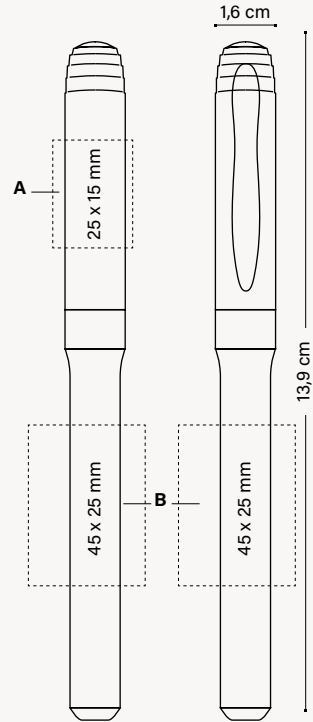

OPTIONAL SPECIAL PACKAGING



+ INFO PAGES 262 TO 266

*Can be used
as bookmark*

EXTERNAL PACKAGING



250 ± 2,8KG

*You can have
it as a set!*



MANUFACTURED
AND PRINTED IN
BIC FACTORIES



REGULATORY
COMPLIANCE



RESISTANT
TIP

WRITING MODES



MARKER
MK

PRINTING TECHNIQUES



SCREEN
PRINTING

SUSTAINABILITY



BIC® PERMANENT MARKER ECOLUTIONS®

ecolutions



MADE FROM
52% RECYCLED MATERIAL*

Add the Möbius loop to your artwork at no additional charge. Please specify "Print the Möbius loop" on your order. (Möbius loop imprint defaults to left-hand hand corner.)

*Excluding ink system



PHARMACEUTICAL WASTE

Decoration

1210

BIC® PERMANENT MARKER
ecolutions® 1210

A SP: max. 1 col.

MOQ 250 units

1210

BIC® PERMANENT MARKER
ecolutions® 1210

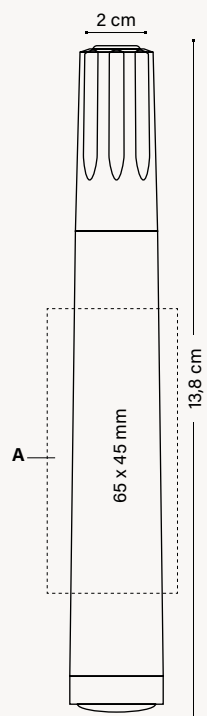

EXTERNAL PACKAGING



MANUFACTURED AND PRINTED IN BIC FACTORIES



FABRIQUÉ EN FRANCE MADE IN FRANCE



REGULATORY COMPLIANCE



RESISTANT TIP



WRITING MODES



MARKER MK

PRINTING TECHNIQUES



SCREEN PRINTING

SUSTAINABILITY



PHARMACEUTICAL WASTE

IMPRIM'VERT®

ecolutions®

*The percentage is calculated on total weight of product excluding ink system. Due to the recycled content of the raw materials used to make the product, we cannot guarantee that the colours shown in the catalogue or colours customised to order will always have the same colour and appearance. See pages 274-277 for a detailed explanation of the icons.

BIC® MECHANICAL PENCILS

Stay sharp with these first-class mechanical pencils! They're solid and resistant, never need sharpening and write smoother and darker than ever!

FR

Toujours prêts avec ces porte-mines de grande qualité. Ils sont solides et leurs mines sont résistantes. Ils n'ont pas besoin d'être taillés et offrent une écriture plus fluide et plus intense que jamais !

IT

Sempre pronti con questi portamine di qualità superiore. Sono solidi e resistenti, non hanno bisogno di essere temperati e scrivono in modo più morbido e intenso che mai!

DE

Stets schreibbereit mit diesen Qualitäts-Druckbleistiften. Solide und resistent, ohne Anspitzen, schreiben diese Bleistifte leichter und kräftiger denn je!

ES

Siempre preparados con estos portaminas de calidad superior. Son sólidos, resistentes y no es necesario sacarle punta. ¡Escribe más fluido e intenso que nunca!



BIC® MATIC®
BIC® MEDIA CLIC MECHANICAL PENCIL
BIC® MEDIA CLIC GRIP MECHANICAL PENCIL



ECO version and standard at the same price!

ecolutions®



MADE FROM **74% RECYCLED MATERIAL***

Add the Möbius loop to your artwork at no additional charge. Please specify it on your order. (Möbius loop imprint defaults to left-hand corner.)

*Excluding lead



PHARMACEUTICAL WASTE

1120

BIC® MATIC®
1120 Opaque



02/02

12/12

03/03

07/07

01/01

100%

1E40

BIC® MATIC®
ecolutions® 1E40 Opaque



04/8C

100%

**The percentage is calculated based on the total weight of the mechanical pencil excluding lead. Due to the recycled content of the raw materials used to make the product, we cannot guarantee that the colours shown in the catalogue or colours customised to order will always have the same colour and appearance.*

1120 / 1E40

BIC® MATIC
1120
ecolutions® 1E40

A SP: max. 1 col.
B/C: max. 2 col.

MOQ 500 units

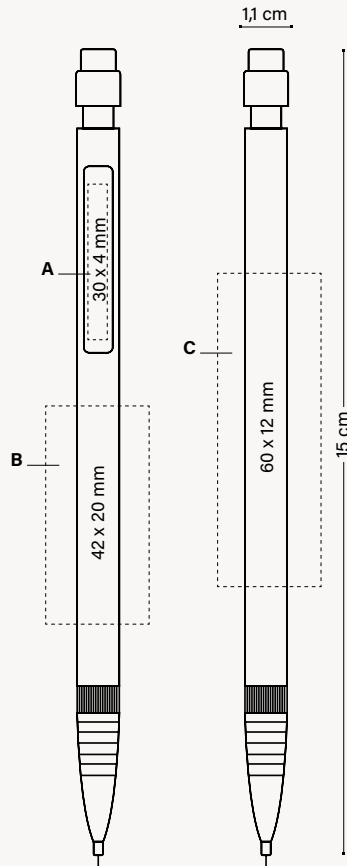

OPTIONAL SPECIAL PACKAGING



PLASTIC
POUCH

+ INFO PAGES 262 TO 266

*Can be used
as bookmark*

EXTERNAL PACKAGING



500 ± 3,1 KG

Decoration



MANUFACTURED
AND PRINTED IN
BIC FACTORIES



MADE IN FRANCE



REGULATORY
COMPLIANCE



ISO
certified



SMOOTHER AND
DARKER WRITING



EASY TO
USE AND ERASE



2 LEADS 9 CM

**WRITING
MODES**



MECHANICAL PENCIL MP
Ø 0,7 MM

**PRINTING
TECHNIQUES**



SCREEN PRINTING

SUSTAINABILITY



IMPRIM'VERT®

ecolutions®



PHARMACEUTICAL
WASTE

BIC
GRAPHIC

BIC®
WRITING INSTRUMENTS

OTHER WRITING
INSTRUMENTS

NOTEBOOKS

BIC® / DJEOP® LIGHTERS
AND BIC® CASES

BIC®
PACKAGING

GENERAL
INFORMATION

See pages 274-277 for a detailed explanation of the icons.

BIC® MEDIA CLIC MECHANICAL PENCIL

1028



*Iconic BIC® Boy
is embossed*

BIC® MEDIA CLIC
1028 Mechanical pencil
Opaque



13

1028

BIC® MEDIA CLIC
1028 Mechanical pencil
Frosted



5C



39

BIC® MEDIA CLIC GRIP MECHANICAL PENCIL

ECO version and standard at the same price!

ecolutions®



MADE FROM **98% RECYCLED MATERIAL***
*From barrel



PLASTIC CAR PARTS

1021

BIC® MEDIA CLIC GRIP
1021 Mechanical pencil
Frosted



71/69

82/69

40/69

1E21

BIC® MEDIA CLIC GRIP
ecolutions® 1E21 Mechanical pencil
Opaque



01/03

01/05

01/02

01/07

* The percentage is calculated based on total weight of the barrel. Due to the recycled content of the raw materials used to make the product, we cannot guarantee that the colours shown in the catalogue or colours customised to order will always have the same colour and appearance.

BIC® MEDIA CLIC MECHANICAL PENCIL

1028

BIC® MEDIA CLIC
1028 Mechanical pencil

1021 / 1E21

BIC® MEDIA CLIC GRIP
1021 Mechanical pencil
eColutions® 1E21 Mechanical pencil

MIX & MATCH No extra charge

MOQ 500 units
Standard colours combination

Clip

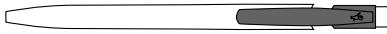

Opaque

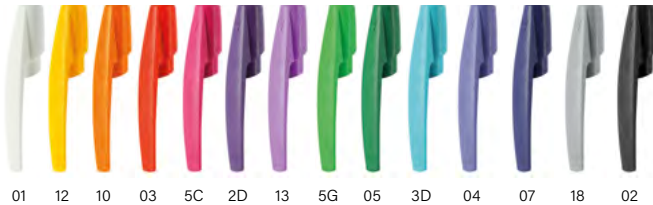

Frosted



01

12

10

03

5C

2D

13

5G

05

3D

04

07

18

02

69

Barrel



Opaque



5C

13

Frosted



39

Barrel & Grip

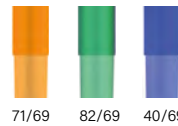

71/69

82/69

40/69

britePix DIGITAL THE SOLUTION FOR FULL COLOUR COMMUNICATION!

eColutions®



PLASTIC CAR PARTS

Standard colours combination*

Barrel & Grip

Opaque

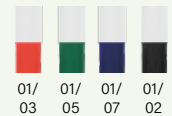

01/03

01/05

01/07

01/02



*From barrel
Add the Möbius loop to your artwork at no additional charge. Please specify "Print the Möbius loop" on your order. (Möbius loop imprint defaults to left-hand corner.)

All colour range available in Digital britePix™

Exact colour match: ≥ 10.000 units 1028

Exact colour match: ≥ 20.000 units 1021 / 1E21



MIX & MATCH



MANUFACTURED AND PRINTED IN BIC FACTORIES



PERSONALIZED COLOURS

WRITING MODES



MECHANICAL PENCIL MP

PRINTING TECHNIQUES



SCREEN PRINTING



DIGITAL

SUSTAINABILITY

eColutions®



PLASTIC CAR PARTS

Decoration

1028

BIC® MEDIA CLIC

1028 Mechanical pencil

A SP: max. 4 col.

B SP: max. 2 col.

C DG: full-colour

MOQ 500 units.

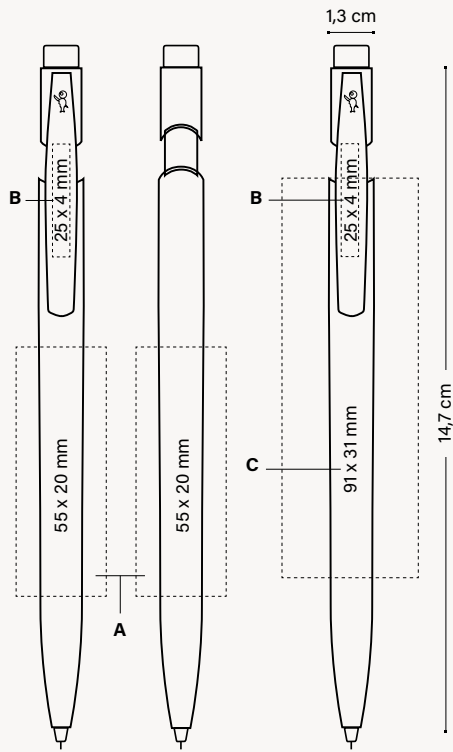

OPTIONAL SPECIAL PACKAGING



ECO SLEEVE

PLASTIC POUCH

WINDOW BOX

+ INFO PAGES 262 TO 266

Can be used as bookmark

EXTERNAL PACKAGING



500 ± 4,1 KG

Decoration

1021 / 1E21

BIC® MEDIA CLIC GRIP

1021 Mechanical pencil

1E21 Mechanical pencil

D SP: max. 4 col.

E SP: max. 2 col.

F DG: full-colour

MOQ 500 units.

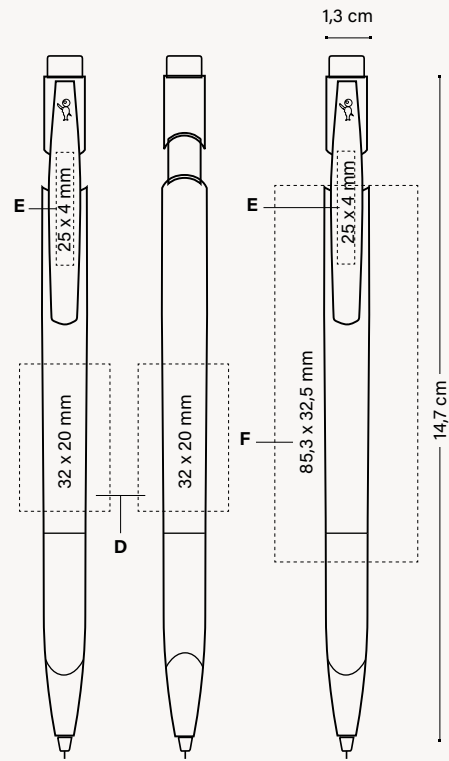

OPTIONAL SPECIAL PACKAGING



ECO SLEEVE

PLASTIC POUCH

WINDOW BOX

+ INFO PAGES 262 TO 266

Can be used as bookmark

EXTERNAL PACKAGING



500 ± 4,3 KG



MANUFACTURED AND PRINTED IN BIC FACTORIES



MADE IN SPAIN

WRITING MODES



MECHANICAL PENCIL MP

PRINTING TECHNIQUES



SCREEN PRINTING



DIGITAL

SUSTAINABILITY



PLASTIC CAR PARTS

See pages 274-277 for a detailed explanation of the icons.

BIC® PENCILS

BIC® KIDS EVOLUTION®

COLOURING SET

Graphite and colouring pencils made from synthetic resin and wood-free, that will not splinter in the event of breaking.

FR

Crayons BIC® et BIC® Kids Evolution® Colouring set

Crayons de graphite et de couleur fabriqués en résine synthétique et sans bois, qui ne font pas d'écharde en cas de brisure.

DE

BIC® Bleistifte und BIC® Kids Evolution® Colouring Set

Graphit- und Farbstifte aus synthetischem Harz und ohne Holz, die bei Bruch nicht splintern.

IT

Matite BIC® e BIC® Kids Evolution® Colouring set

Matite di grafite e colorate realizzate in resina sintetica e senza legno, che non scheggiano in caso di rottura.

ES

Lápices BIC® y BIC® Kids Evolution® Colouring set

Lápices de grafito y de colores fabricados con resina sintética y sin madera, que no se astillan en caso de romperse.



BIC® PENCILS
BIC® KIDS EVOLUTION®
COLOURING SET



BIC® EVOLUTION® ECOLUTIONS®

EVOLUTION® **ecolutions®**

britePix DIGITAL THE SOLUTION FOR FULL COLOUR COMMUNICATION!

britePix DIGITAL THE SOLUTION FOR FULL COLOUR COMMUNICATION!

Embossed iconic BIC® brand!



MADE FROM 64% RECYCLED MATERIAL*



FRIGES AND YOGURT POTS



MADE FROM 52% RECYCLED MATERIAL*



FRIGES AND YOGURT POTS

1150

GRAPHITE PENCIL CUT END
ecolutions® 1150

1151

GRAPHITE PENCIL WITH ERASER
ecolutions® 1151



Protective sheath

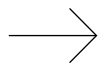

20



02



03



01

100%



100%

360° Printing



20



02



03



01

100%

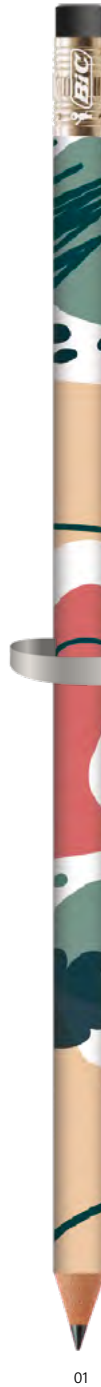

100%

360° Printing

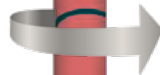

*The percentage is calculated based on total weight of the product. Due to the recycled content of the raw materials used to make the product, we cannot guarantee that the colours shown in the catalogue or colours customised to order will always have the same colour and appearance.

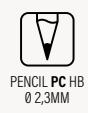

SUSTAINABILITY



MADE FROM UP TO 64% RECYCLED MATERIAL*



Add the Möbius loop to your artwork at no additional charge. Please specify it on your order. (Möbius loop imprint defaults to left-hand hand corner.)**

1150 / 1151

GRAPHITE PENCIL
1150 / 1151

MIX & MATCH No extra charge

MOQ 500 units
Standard colours combination

Eraser

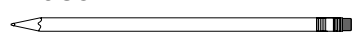

Opaque



Ferrule

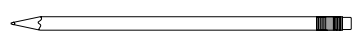

Opaque

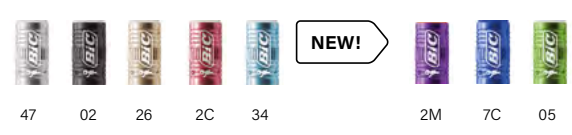

Barrel



Opaque

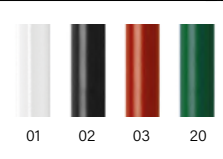

**Percentage indicated in the Möbius loop depend on the product selected (1150 or 1151). Please, see details at the product description.

See pages 274-277 for a detailed explanation of the icons.

1150

BIC® EVOLUTION® ECOLUTIONS®
ecolutions® 1150 (Pencil cut end)

A SP: max. 1 col.

MOQ 500 units

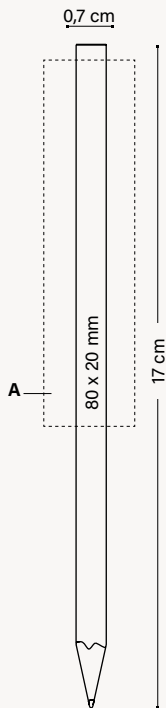

1151

BIC® EVOLUTION® ECOLUTIONS®
ecolutions® 1151 (Pencil with eraser)

MOQ 500 units

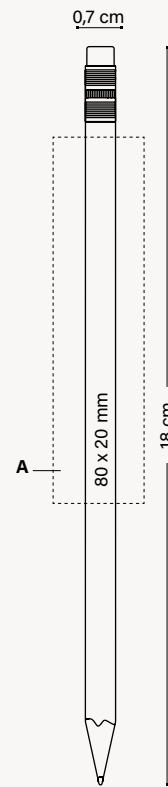

OPTIONAL SPECIAL PACKAGING



PLASTIC
 POUCH
 (x 3 UNITS)

+ INFO PAGES 262 TO 266

*Can be used
 as bookmark*

EXTERNAL PACKAGING



500 ± 3,5 KG

Decoration

1150

BIC® EVOLUTION® ECOLUTIONS®
ecolutions® 1150 (Pencil cut end Digital)

A DG: full-colour (area for images)

MOQ 500 units

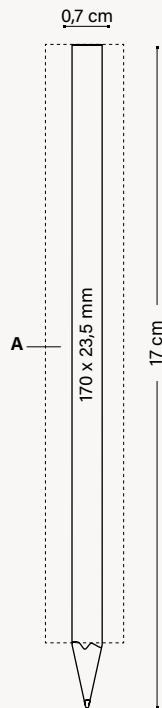

1151

BIC® EVOLUTION® ECOLUTIONS®
ecolutions® 1151 (Pencil with eraser Digital)

MOQ 500 units

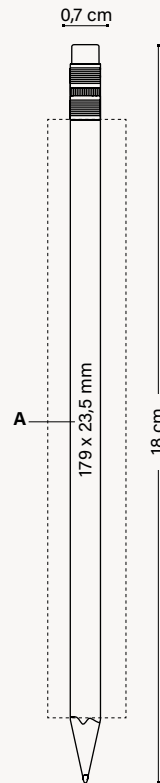

OPTIONAL SPECIAL PACKAGING



PLASTIC POUCH (X 3 UNITS)

+ INFO PAGES 262 TO 266

Can be used as bookmark

EXTERNAL PACKAGING



500 ± 3,5 KG



MANUFACTURED AND PRINTED IN BIC FACTORIES



MADE IN FRANCE



REGULATORY COMPLIANCE



RESISTANT TIP



NO SPLINTER



PROTECTIVE SHEATH



EASY TO USE AND ERASE

WRITING MODES



PENCIL PC HB Ø 2,3MM

PRINTING TECHNIQUES



SCREEN PRINTING



DIGITAL

SUSTAINABILITY



IMPRIM'VERT®

ecolutions®



FRIDGES AND YOGURT POTS

See pages 274-277 for a detailed explanation of the icons.

BIC GRAPHIC

BIC® WRITING INSTRUMENTS

OTHER WRITING INSTRUMENTS

NOTEBOOKS

BIC® / D'JEEP® LIGHTERS AND BIC® CASES

BIC® PACKAGING

GENERAL INFORMATION

BIC® KIDS EVOLUTION® COLOURING SET



Ultra-resistant Wood-free pencils that are easy to sharpen.
Ideal for everyday drawing and colouring.

MADE FROM
51% RECYCLED MATERIAL*

*Excluding lead

FRIDGES AND
YOGURT POTS

*Safe usage
for kids*

- Does not splinter on breaking
- Resistant to chewing

1608

BIC® KIDS EVOLUTION® COLOURING SET
eColutions® 1608

*Fully customisable
carton wallet***

NEW!



*The percentage is calculated based on the total weight of the pencil excluding lead.
**Non-personalisable pencils

1608

BIC® KIDS EVOLUTION® COLOURING SET
ecolutions® 1608

A DG: full-colour

MOQ 1200 units.

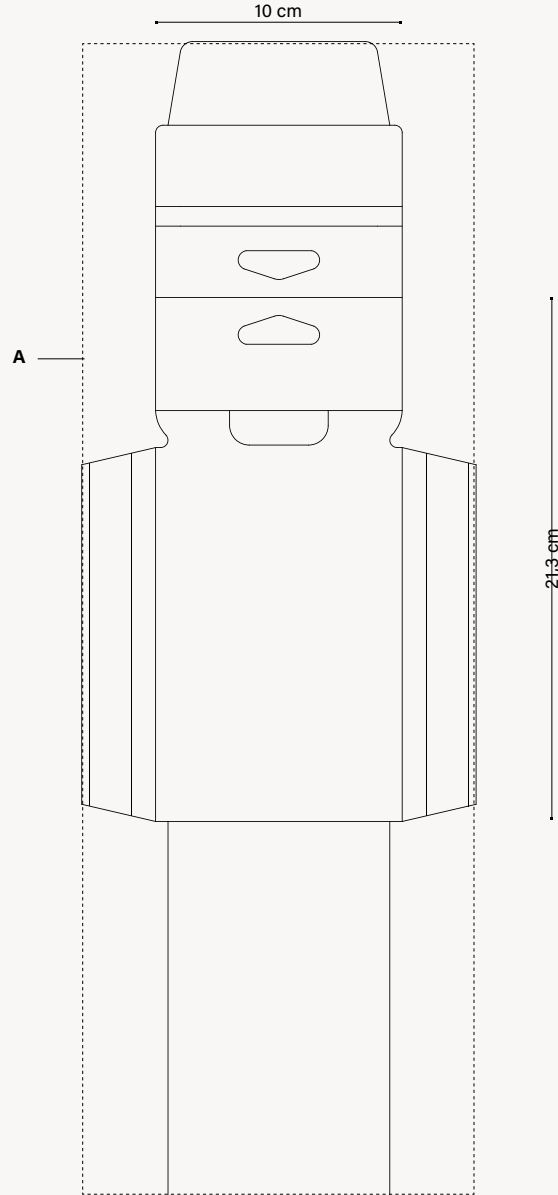

Decoration



WRITING MODES

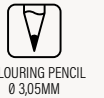

SUSTAINABILITY



EXTERNAL PACKAGING



500 ± 2,5 KG (ONLY PENCIL)
± 5 KG (WITH CARDBOARD PACKAGING)

PACKAGING



See pages 274-277 for a detailed explanation of the icons.

BIC
GRAPHIC

BIC®
WRITING INSTRUMENTS

OTHER WRITING
INSTRUMENTS

NOTEBOOKS

BIC® / D'JEEP® LIGHTERS
AND BIC® CASES

BIC®
PACKAGING

GENERAL
INFORMATION

SPROUT™ GRAPHITE PENCIL



This pencil enables you to convey a meaningful message and sets the foundation for a lasting relationship. The sustainable pencil that you can plant after use and grow into herbs, vegetables, fruits or flowers.

FR
Le crayon durable que vous pouvez planter après son utilisation et faire pousser des plantes, des légumes, des fruits ou des fleurs.

DE
Dieser Stift ermöglicht es Ihnen, tiefgreifende Botschaften zu übermitteln und legt den Grundstein für dauerhafte Beziehungen. Der nachhaltige Bleistift kann nach Gebrauch eingepflanzt werden, um sich in Kräuter, Obst, Gemüse oder Blumen zu verwandeln.

IT
La matita sostenibile che può essere piantata dopo essere stata utilizzata e cresce come un'erba, un vegetale, un frutto o un fiore.

ES
El lápiz sostenible que puedes plantar después de ser utilizado y crece como una hierba, un vegetal, una fruta o una flor.

53062

SPROUT™ GRAPHITE PENCIL
53062

With seeds



Standard barrel



Customised barrel

Standard cardboard!



Standard cardboard packaging

Customisable cardboard!

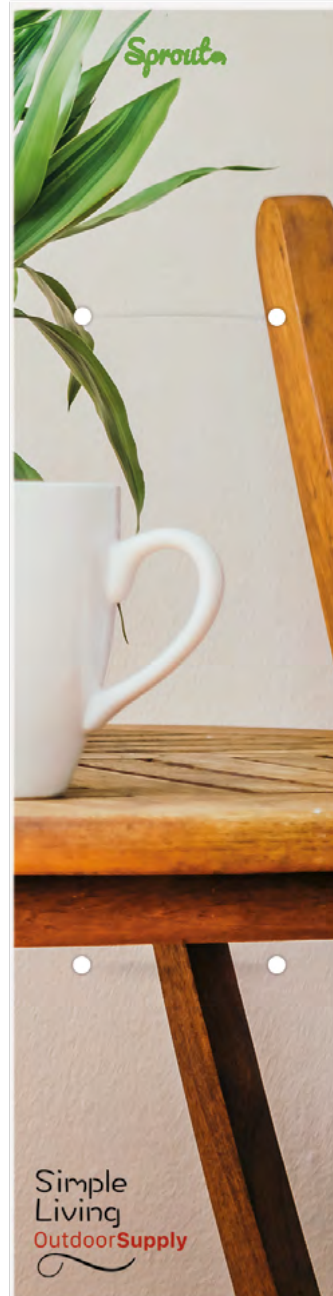

Personalised cardboard packaging



Rear side



Graphite Lead

Once the pencil is too short to write with, plant the stub and watch your message turn into a pot of beautiful herbs, flowers, fruits or vegetables.

Choose between 9 different seeds!

NEW!



STRAWBERRY



Spruce



Sunflower



Daisy



Sage



Cherry tomato



Forget-me-not



Basil



Thyme

53062

SPROUT™ GRAPHITE PENCIL

53062

A LE
B DG

MOQ 100 units

Pencil sharpening is offered at an extra charge

Decoration



WRITING MODES



PENCIL PC HB
Ø 2,3MM

PRINTING TECHNIQUES



LASER



DIGITAL

SUSTAINABILITY



FSC AND
RECYCLABLE CARDBOARD

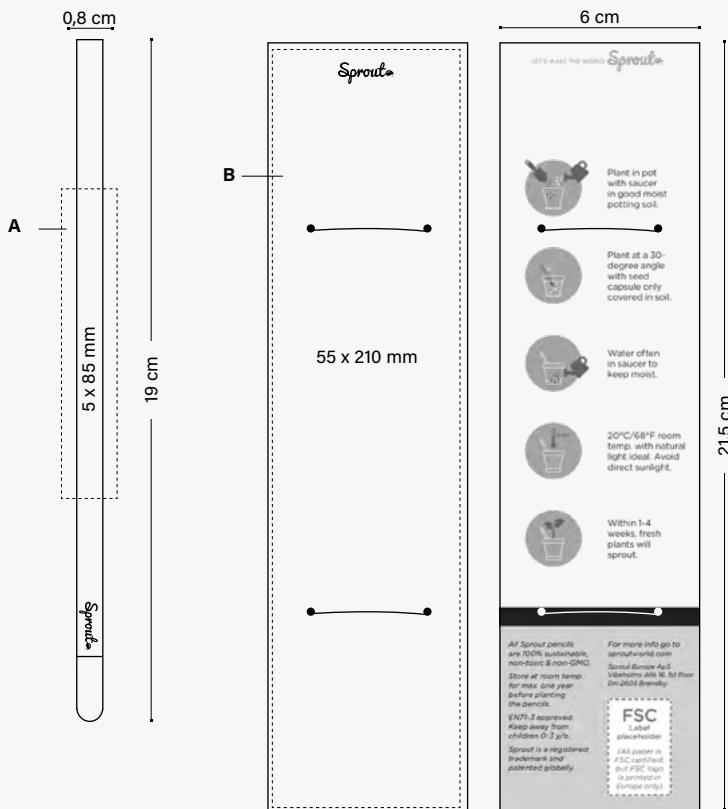

EXTERNAL PACKAGING



500 ± 2,5 KG (ONLY PENCIL)
± 5 KG (WITH CARDBOARD PACKAGING)

PACKAGING



CHECK OUT THE VIDEO

See pages 274-277 for a detailed explanation of the icons.

BIC GRAPHIC

BIC WRITING INSTRUMENTS

OTHER WRITING INSTRUMENTS

NOTEBOOKS

BIC / DEEP LIGHTERS AND BIC CASES

BIC PACKAGING

GENERAL INFORMATION

Contents

OTHER WRITING INSTRUMENTS

02

PLASTIC PENS

Basic Pen	190
Click Pen	192
Striped Grip Pen	194

STYLUS PENS

Sleek Stylus Pen	196
------------------	-----

BASIC PEN

12010

BASIC PEN

12010

Colour ink



12010

BASIC PEN
12010

A/B SP: max. 1 col.

MOQ 500 units

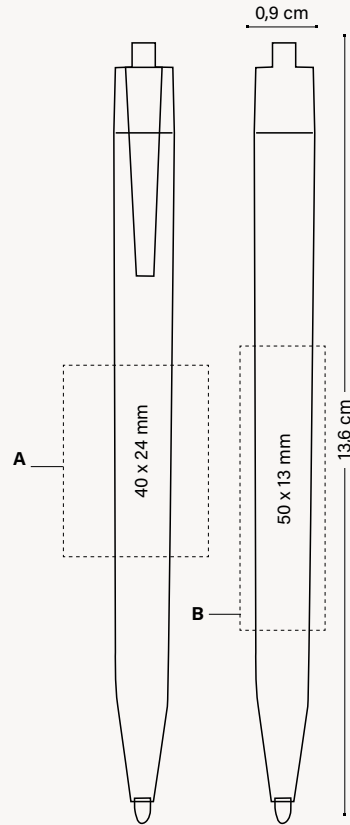

EXTERNAL PACKAGING



Decoration



WRITING MODES



PRINTING TECHNIQUES



SUSTAINABILITY



See pages 274-277 for a detailed explanation of the icons

CLICK PEN

11748

CLICK PEN

11748

Colour ink



11748

CLICK PEN

11748

A/B SP: max. 4 col.
C/D PD: max. 4 col.

MOQ 500 units

Decoration

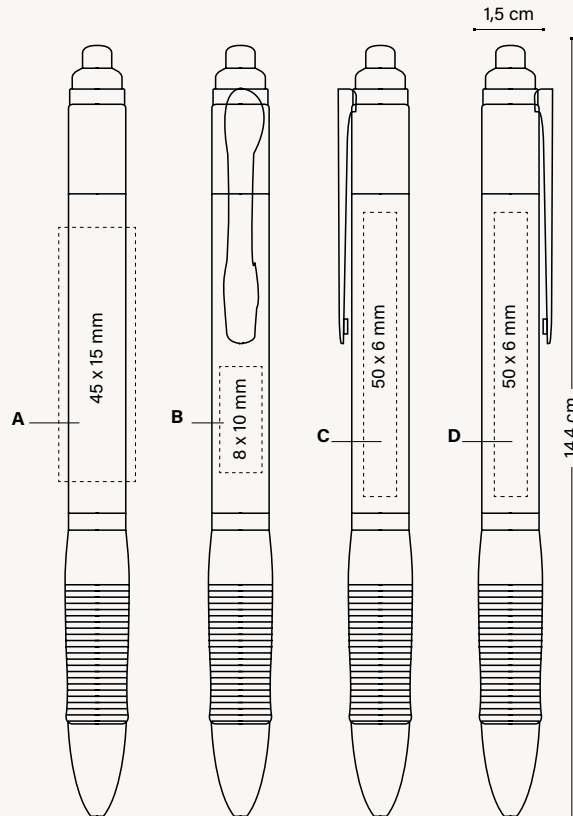

EXTERNAL PACKAGING



1000 ± 9,5 KG



WRITING MODES



PRINTING TECHNIQUES



SUSTAINABILITY



BIC
GRAPHIC

BIC®
WRITING INSTRUMENTS

OTHER WRITING
INSTRUMENTS

NOTEBOOKS

BIC® / DJEOP® LIGHTERS
AND BIC® CASES

BIC®
PACKAGING

GENERAL
INFORMATION

See pages 274-277 for a detailed explanation of the icons

STRIPED GRIP PEN

11243

STRIPED GRIP PEN

11243

Colour ink



11243

STRIPED GRIP PEN

11243

A SP: max. 2 col.

B PD: max. 1 col.

MOQ 500 units

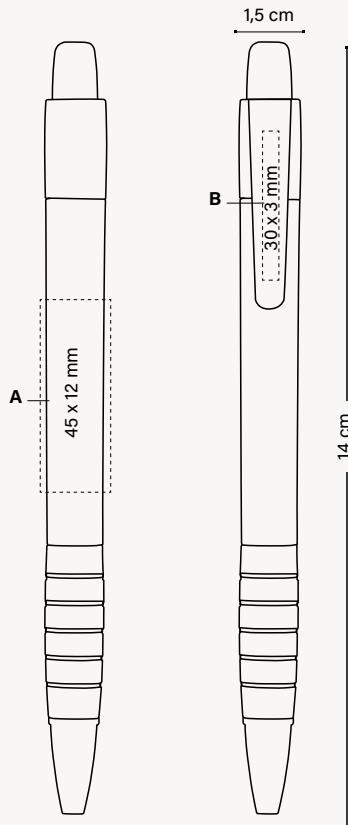

EXTERNAL PACKAGING



Decoration



WRITING MODES



PRINTING TECHNIQUES



SUSTAINABILITY



See pages 274-277 for a detailed explanation of the icons

SLEEK STYLUS PEN

11666

SLEEK STYLUS PEN

11666

Colour ink



01

100%

11747

SLEEK STYLUS MATT PEN

11747

Colour ink



47



04

100%

11976

SLEEK STYLUS EXECUTIVE PEN

11976



26

Available in
blue ink



2N

Available in
black ink

100%

11666 / 11747 / 11976

SLEEK STYLUS PEN

11666

SLEEK STYLUS MATT PEN

11747

SLEEK STYLUS EXECUTIVE PEN

11976

A SP: max. 1 col.

B SP: max. 2 col.

C LE

MOQ 500 units (SP)

MOQ 100 units (LE)

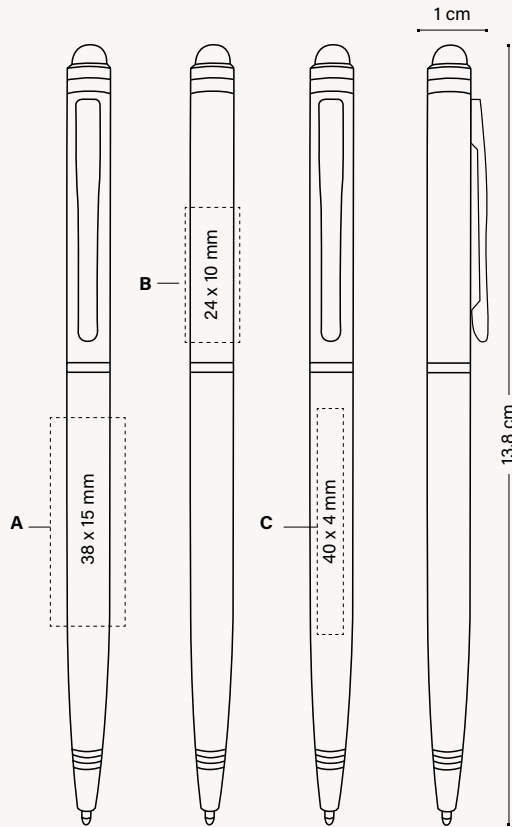

EXTERNAL PACKAGING



(11666)
900 ± 12,4 KG



(11747 / 11976)
800 ± 13 KG

Decoration



WRITING MODES



PRINTING TECHNIQUES



SUSTAINABILITY



BIC
GRAPHIC

BIC®
WRITING INSTRUMENTS

OTHER WRITING
INSTRUMENTS

NOTEBOOKS

BIC® / DJEEP® LIGHTERS
AND BIC® CASES

BIC®
PACKAGING

GENERAL
INFORMATION

See pages 274-277 for a detailed explanation of the icons

NOTEBOOKS

03

ROCKETBOOK®

Rocketbook® Core Executive A5	202
Rocketbook® Fusion Executive A5	204
Rocketbook® Core Mini A6	206

MOLESKINE

Moleskine Classic Notebooks	210
Moleskine Cahier Journals	214

ROCKETBOOK®

Rocketbook® combines the freedom of a traditional pen and paper notebook with app technology to send handwritten notes quickly and securely to the cloud folder of your choice. It comes with instructions for achieving a clean page that can be used endlessly. You can choose the Core for taking notes, making graphs and sketching, or go one step further with the Fusion for planning, making lists and setting goals.

FR

Rocketbook® combine l'avantage d'un stylo traditionnel avec un carnet et une application pour envoyer des notes écrites à la main de manière rapide et sécurisée au fichier cloud de votre choix. Suivez les instructions indiquées pour effacer vos notes afin de pouvoir réutiliser immédiatement votre carnet. Vous avez le choix entre le modèle Core pour prendre des notes, réaliser des graphiques, des croquis... ou passez au modèle supérieur avec le Fusion pour planifier, lister ou organiser vos objectifs.

IT

Rocketbook® combina la libertà di un tradizionale taccuino di carta e penna a sfera con la sua app per inviare in modo veloce e sicuro gli appunti scritti a mano alla tua cartella Cloud. Segui le istruzioni incluse per potere riutilizzare la pagina tutte le volte che vorrai. È possibile scegliere tra il modello Core per prendere appunti, tracciare grafici o disegnare, oppure fare un passo avanti con il modello Fusion per pianificare, elencare o fissare obiettivi.

DE

Rocketbook® kombiniert die Freiheit eines klassischen Kugelschreibers und Papier-Notizbuchs mit seiner App, mit der Sie Ihre handschriftlichen Notizen schnell und sicher an Ihren Cloud-Ordner senden können. Befolgen Sie die beiliegende Anleitung für die unbeschriebenen Seiten, die Sie beliebig oft verwenden können. Sie haben die Wahl zwischen dem Core-Modell für Notizen, grafische Darstellungen und Zeichnungen und dem Fusion-Modell, das darüber hinaus noch Vorlagen für Planungen, To-Do-Listen und Zielsetzungen enthält.

ES

Rocketbook® combina la libertad de un bolígrafo tradicional y un cuaderno de papel con su app para enviar notas escritas a mano de forma rápida y segura a tu carpeta en la nube. Sigue las instrucciones incluidas para obtener una página en blanco que se puede utilizar tantas veces como quieras. Puedes elegir entre el modelo Core para tomar notas, graficar o dibujar, o ve un paso más allá con el modelo Fusion para planificar, enumerar o establecer metas.

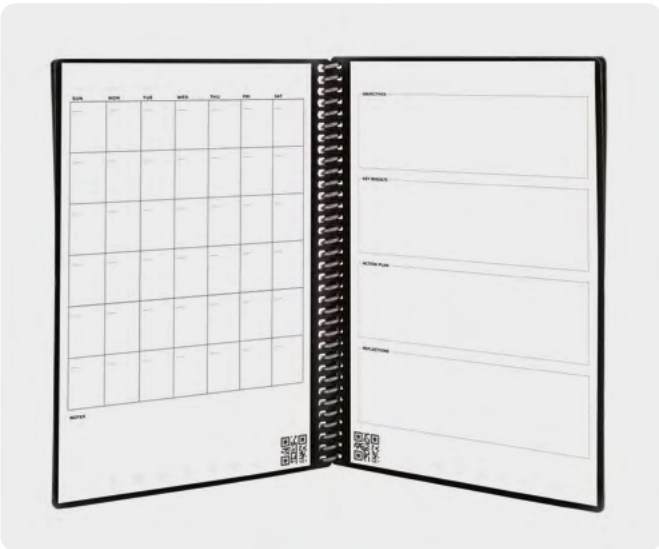

ROCKETBOOK® CORE EXECUTIVE A5
ROCKETBOOK® FUSION EXECUTIVE A5
ROCKETBOOK® CORE MINI A6



3728

NEW IMPROVED MOQ 25 UNITS!

ROCKETBOOK® CORE EXECUTIVE A5
3728



07
●
Navy Blue



01
○
White



02
●
Black

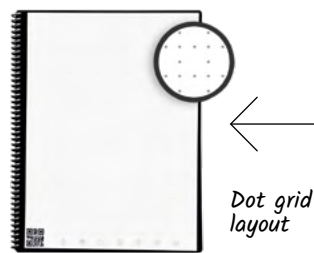
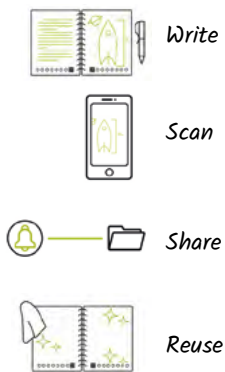

The box always includes:

- Notebook
- Erasable pen
- Cloth
- Instructions

3728

**ROCKETBOOK® CORE
EXECUTIVE A5**

3728

A SP: max. 1 col.

B BP: full-colour

C HS: max. 1 col.

36 pages

MOQ 25 units

Decoration



**PRINTING
TECHNIQUES**



SUSTAINABILITY

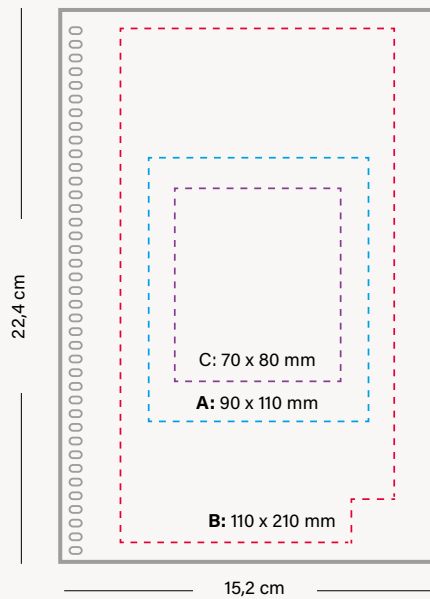

SPECIAL PACKAGING ALWAYS INCLUDED



GIFT BOX
CORE A5

EXTERNAL PACKAGING



50 ± 5,8 KG



DOWNLOAD THE APP



DOWNLOAD THE APP



HOW IT WORKS

See pages 274-277 for a detailed explanation of the icons

BIC
GRAPHIC

BIC®
WRITING INSTRUMENTS

OTHER WRITING
INSTRUMENTS

NOTEBOOKS

BIC® / DEEP® LIGHTERS
AND BIC® CASES

BIC®
PACKAGING

GENERAL
INFORMATION

3726

NEW IMPROVED MOQ 25 UNITS!

ROCKETBOOK® FUSION EXECUTIVE A5
3726



01
○
White



02
●
Black

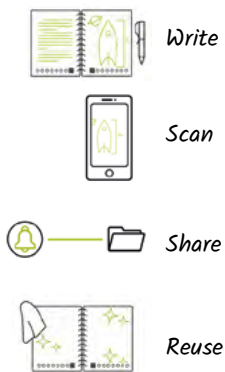

Seven page styles

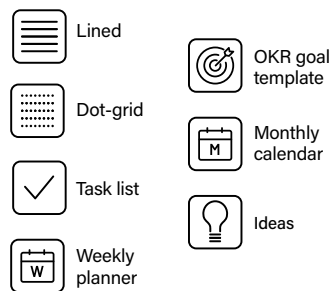

Customisation visible in window cutout



- The box always includes:
- Notebook
 - Erasable pen
 - Cloth
 - Instructions

3726

**ROCKETBOOK® FUSION
EXECUTIVE A5**

3726

A SP: max. 1 col.

B BP: full-colour

C HS: max. 1 col.

42 pages

MOQ 25 units

Decoration



**PRINTING
TECHNIQUES**



SUSTAINABILITY

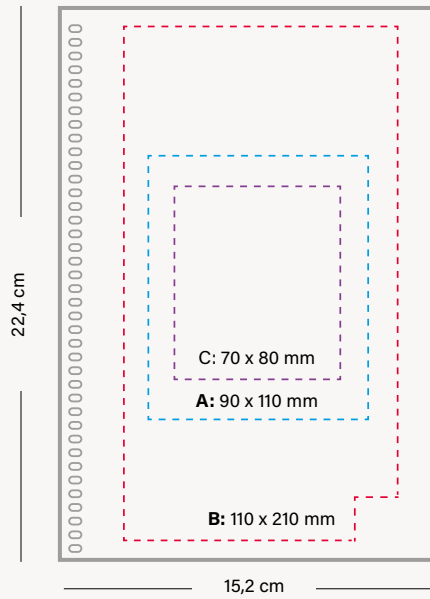

**SPECIAL PACKAGING
ALWAYS INCLUDED**



GIFT BOX
FUSION A5

EXTERNAL PACKAGING



50 ± 5,8 KG



DOWNLOAD THE APP



DOWNLOAD THE APP



HOW IT WORKS

See pages 274-277 for a detailed explanation of the icons

BIC
GRAPHIC

BIC®
WRITING INSTRUMENTS

OTHER WRITING
INSTRUMENTS

NOTEBOOKS

BIC® / DLEEP® LIGHTERS
AND BIC® CASES

BIC®
PACKAGING

GENERAL
INFORMATION

3727

NEW IMPROVED MOQ 25 UNITS!

ROCKETBOOK® CORE MINI A6
3727

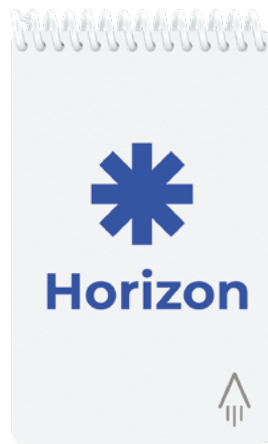

01
○
White



02
●
Black

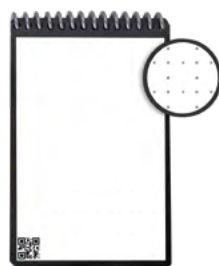
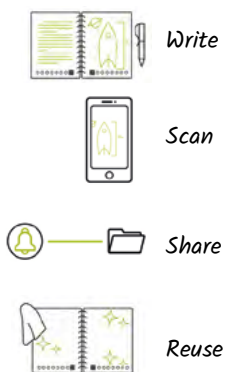

←
Dot grid layout



←
Customisation visible in window cutout

- The box always includes:
- Notebook
 - Erasable pen
 - Cloth
 - Instructions

3727

**ROCKETBOOK® CORE
MINI A6**

3727

A SP: max. 1 col.

B BP: full-colour

C HS: max. 1 col.

48 pages

MOQ 25 units

Decoration



**PRINTING
TECHNIQUES**



SUSTAINABILITY

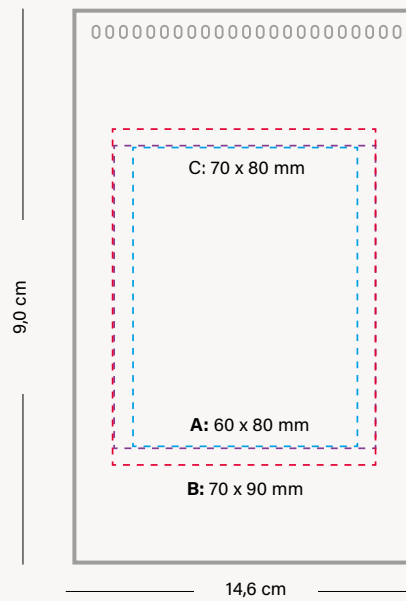

SPECIAL PACKAGING ALWAYS INCLUDED



GIFT BOX
CORE A6

EXTERNAL PACKAGING



50 ± 2,6 KG



DOWNLOAD THE APP



DOWNLOAD THE APP



HOW IT WORKS

See pages 274-277 for a detailed explanation of the icons

MOLESKINE®

More than a Notebook, it's an experience

 **MOLESKINE**

FR

Plus qu'un carnet, c'est une expérience

Des matériaux et finitions de haute qualité.

Des options de personnalisation avec des logos et des dessins sur les couvertures et les pages intérieures.

Le bandeau peut être personnalisé par impression numérique.

Sérigraphie, marquage à chaud et gaufrage.

Des designs classiques et sophistiqués.

ES

Más que un cuaderno, una experiencia

Materiales y acabados de alta calidad.

Opciones de personalización con logotipos y diseños en las cubiertas y las páginas interiores.

La banda de papel puede personalizarse en impresión digital.

Serigrafía, hot stamping y grabado bajo relieve.

Diseños clásicos y sofisticados.



Classic, sophisticated designs.

High-quality materials and finishes.

Screen printing, hot stamping and debossing.

The paperband can be personalized in digital printing.

Customization options with logos and designs on the covers and inner pages.



Product only available in France, Spain, Portugal, and Greece.

15056

**MOLESKINE® CLASSIC NOTEBOOK LARGE 13 X 21 CM
HARD COVER**

15056

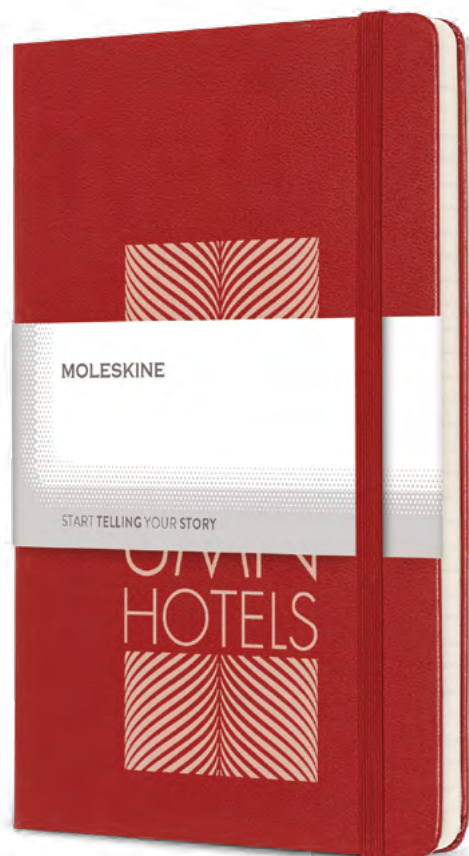

HARD COVER!

- Colourful hard cover.
- Rounded corners, elastic closure and ribbon bookmark.
- Expandable inner pocket at the back.
- Stays fully open at 180°.
- Ruled or plain pages and more layouts are available upon request.
Ivory-coloured, acid-free 70 g/m² paper.
- Wide range of colours, layouts and sizes.
- Classic, sophisticated designs.
- Customisation options for logos and designs on the covers and inner pages.
- Screen printing, hot stamping and debossing. The paperband can be personalised in digital printing.

FR

Couverture rigide !

- Couverture rigide de couleur
- Coins arrondis, fermeture élastique et signet en ruban.
- Poche intérieure extensible au dos.
- Reste complètement ouvert à 180°.
- Les pages lignées ou unies et d'autres mises en page sont disponibles sur demande. Papier de couleur ivoire, sans acide, 70 g/m².
- Une vaste gamme de couleurs, de présentations et de formats.
- Des designs classiques et sophistiqués.
- Des options de personnalisation pour les logos et les dessins sur les couvertures et les pages intérieures.
- Sérigraphie, marquage à chaud et gaufrage. Le bandeau peut être personnalisé par impression numérique.

ES

¡Tapa dura!

- Tapa dura de colores.
- Esquinas redondeadas, cierre elástico y cinta marcapáginas.
- Bolsillo interior expandible en la parte trasera.
- Se mantiene totalmente abierta a 180°.
- Páginas a rayas o lisas y más diseños disponibles previa solicitud. Papel sin ácido de color marfil de 70 g/m².
- Amplia gama de colores, diseños y tamaños.
- Diseños clásicos y sofisticados.
- Opciones de personalización con logotipos y diseños en las cubiertas y las páginas interiores.
- Serigrafía, estampación en caliente y grabado bajorrelieve. La banda de papel puede personalizarse en impresión digital.

Decoration

15056

MOLESKINE® CLASSIC NOTEBOOK
15056 (Hard cover large)

- A SP: max. 1 col.
- B 3D: transparent
- C BP: BritePix™
- D DG: paperband: CMYK
- E HS: max. 1 col.

INTERIOR PAGES:

240: 15056
Ivory-coloured 70 g/m² paper

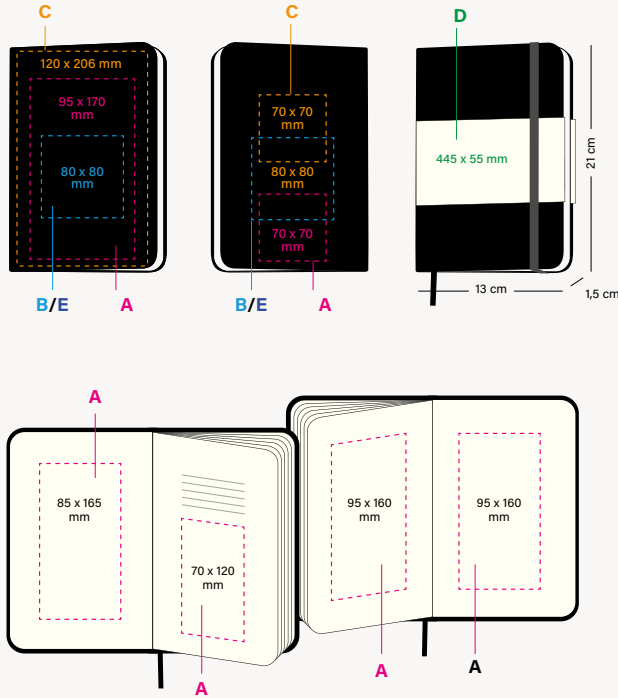

15056 HARD COVER



LINED PAPER

- | | | | | |
|-----------------|---------------|--------------------------|--------------------|---------------|
| ● Black | ● Slate Grey | AVAILABLE UNDER REQUEST: | | ● Reef Blue |
| ● Sapphire Blue | ● Scarlet Red | ● Lemon Green | ● Amaranth Red | |
| ● Prussian Blue | ○ White | ● Citron Yellow | ● Coral Orange | ● Earth Brown |
| | | ● Willow Green | ● Orange Yellow | ● Daisy Pink |
| | | ● Oxide Green | ● Brilliant Violet | |
| | | ● Myrtle Green | ■ SQUARED PAPER | |

15056 HARD COVER



PLAIN PAPER

- | | | |
|-----------------|--------------------------|----------------|
| ● Black | AVAILABLE UNDER REQUEST: | ● Reef Blue |
| ● Sapphire blue | | ● Earth Brown |
| ● Scarlet Red | | ● Myrtle Green |



PRINTING TECHNIQUES



SCREEN PRINTING



BRIPEX™



HOT STAMPING



DEBOSSING

SUSTAINABILITY



FSC AND RECYCLABLE CARDBOARD

BIC GRAPHIC

WRITING INSTRUMENTS

OTHER WRITING INSTRUMENTS

NOTEBOOKS

BIC® / DLEEP® LIGHTERS AND BIC® CASES

BIC® PACKAGING

GENERAL INFORMATION

See pages 274-277 for a detailed explanation of the icons

15065

**MOLESKINE® CLASSIC NOTEBOOK LARGE 13 X 21 CM
SOFT COVER**
15065

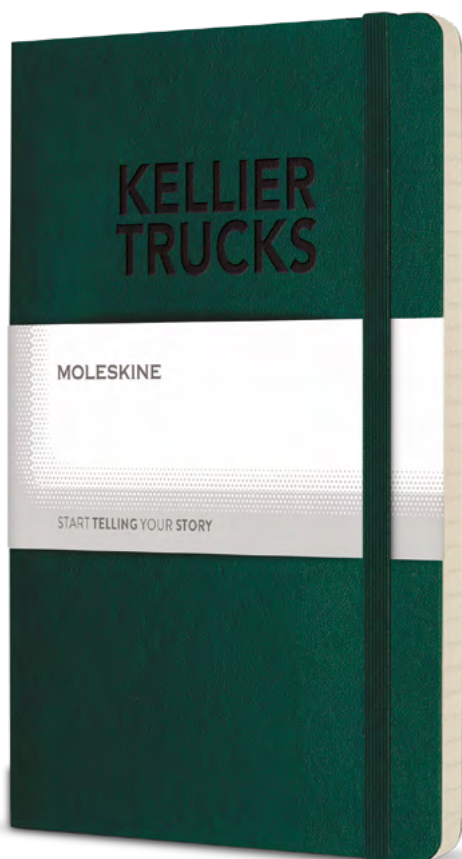

SOFT COVER!

- Colourful soft cover.
- Rounded corners, elastic closure and ribbon bookmark.
- Expandable inner pocket at the back.
- Stays fully open at 180°.
- Ruled or plain pages and more layouts are available upon request.
Ivory-coloured, acid-free 70 g/m² paper.
- Wide range of colours, layouts and sizes.
- Classic, sophisticated designs.
- Customisation options for logos and designs on the covers and inner pages.
- Screen printing, hot stamping and debossing. The paperband can be personalised in digital printing.

FR

Couverture souple !

- Couverture souple de couleur
- Coins arrondis, fermeture élastique et signet en ruban.
- Poche intérieure extensible au dos.
- Reste complètement ouvert à 180°.
- Les pages lignées ou unies et d'autres mises en page sont disponibles sur demande. Papier de couleur ivoire, sans acide, 70 g/m².
- Une vaste gamme de couleurs, de présentations et de formats.
- Des designs classiques et sophistiqués.
- Des options de personnalisation pour les logos et les dessins sur les couvertures et les pages intérieures.
- Sérigraphie, marquage à chaud et gaufrage Le bandeau peut être personnalisé par impression numérique.

ES

¡Tapa blanda!

- Tapa blanda de colores.
- Esquinas redondeadas, cierre elástico y cinta marcapáginas.
- Bolsillo interior expandible en la parte trasera.
- Se mantiene totalmente abierta a 180°.
- Páginas a rayas o lisas y más diseños disponibles previa solicitud. Papel sin ácido de color marfil de 70 g/m².
- Amplia gama de colores, diseños y tamaños.
- Diseños clásicos y sofisticados.
- Opciones de personalización con logotipos y diseños en las cubiertas y las páginas interiores.
- Serigrafía, estampación en caliente y grabado bajo relieve. La banda de papel puede personalizarse en impresión digital.

15065

MOLESKINE® CLASSIC NOTEBOOK

15065 (Soft cover large)

A SP: max. 1 col.

B DB: transparent

C BP: BritePix™

D DG: paperband: CMYK

E HS: max. 1 col.

INTERIOR PAGES:

192: 15065

Ivory-coloured 70 g/m² paper

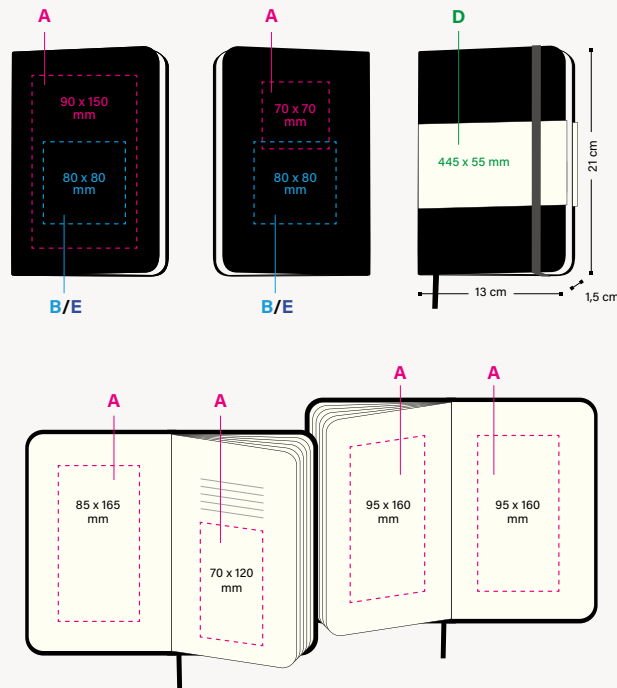

15065 SOFT COVER



LINED PAPER

- Black
- Sapphire blue
- Scarlet Red

AVAILABLE UNDER REQUEST:

- Reef Blue
- Underwater Blue
- Earth Brown

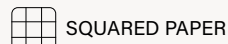

SQUARED PAPER



DOTTED PAPER

15065 SOFT COVER

- Black
- Sapphire blue

AVAILABLE UNDER REQUEST:

- Scarlet Red
- Prussian Blue

Decoration



PRINTED IN BIC FACTORIES

PRINTING TECHNIQUES



SCREEN PRINTING



BRITEPIX™



HOT STAMPING



DEBOSSING

SUSTAINABILITY



FSC AND RECYCLABLE CARDBOARD

See pages 274-277 for a detailed explanation of the icons

15076 / 15067

MOLESKINE® CAHIER JOURNALS
15076 / 15067



Black

Kraft Brown

Practical, customisable and resistant. These are the features of Moleskine® Cahier Journals, which make the best travel companions.

- Resistant, customisable and flexible cover with visible stitching on the spine.
- The last 16 pages are removable.

FR

Pratiques, personnalisables et résistants. Les carnets Moleskine® Cahier, vos meilleurs compagnons de voyage, présentent les caractéristiques suivantes:

- Couverture résistante, personnalisable et souple avec reliure visible sur le dos
- Les 16 dernières pages sont détachables.

ES

Prácticos, personalizables y resistentes. Estas son las características de los cuadernos Moleskine® Cahier, los mejores compañeros de viaje.

- Cubierta resistente, personalizable y flexible, con costuras visibles en el lomo.
- Las últimas 16 páginas son extraíbles.

Decoration



PRINTING TECHNIQUES



SCREEN PRINTING



HOT STAMPING



DEBOSSING

SUSTAINABILITY



FSC AND RECYCLABLE CARDBOARD

15076 / 15067

MOLESKINE® CAHIER JOURNALS

15076 / 15067

A SP: max. 1 col.

B HS: max. 1 col.

C DB: transparente

INTERIOR PAGES:

64: 15076

80: 15067

Ivory-coloured 70 g/m² paper

15076 POCKET

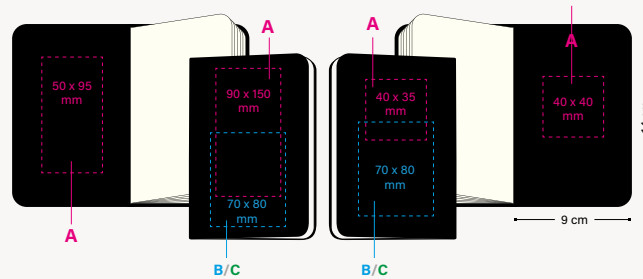

15067 LARGE

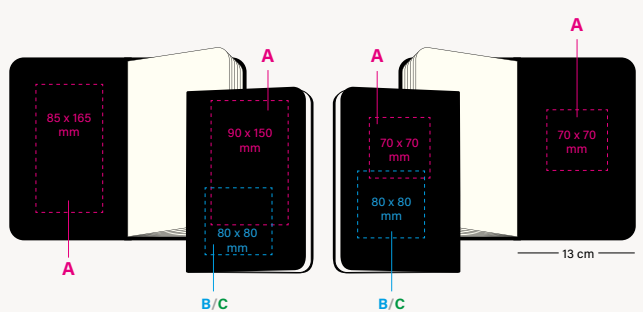

15067 LARGE



LINED PAPER



Black

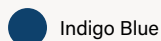

Indigo Blue

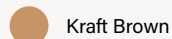

Kraft Brown

AVAILABLE UNDER REQUEST:

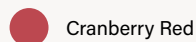

Cranberry Red

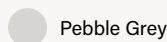

Pebble Grey



PLAIN PAPER

15067 LARGE



LINED PAPER



PLAIN PAPER

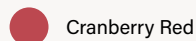

Cranberry Red



Indigo Blue

15076 POCKET



LINED PAPER



Black

AVAILABLE UNDER REQUEST:



Kraft Brown

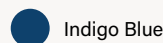

Indigo Blue



PLAIN PAPER

See pages 274-277 for a detailed explanation of the icons

BIC GRAPHIC

BIC® WRITING INSTRUMENTS

OTHER WRITING INSTRUMENTS

NOTEBOOKS

BIC® / DJEEP® LIGHTERS AND BIC® CASES

BIC® PACKAGING

GENERAL INFORMATION

Contents

BIC® / DJEEP® LIGHTERS AND BIC® CASES

04

BIC® LIGHTERS		OTHER PRODUCTS	
BIC® J25 Lighter	222	BIC® EZ Reach™	244
BIC® J23 Lighter	226	BIC® Pocket Ashtray	248
BIC® J26 Lighter	230		
BIC® J38 Lighter	234	DJEEP® LIGHTERS	
		DJEEP® D1 Lighter	250
BIC® LIGHTER CASES			
BIC® Styl'it Luxury Case	238		
BIC® Aluminium Flat Case	240		
BIC® Clip Case	241		
BIC® 3D Case	242		

BIC® lighters.

Our quality, your safety.

All BIC® lighters meet or exceed international standards and regulations requirements (ISO 9994, EN 13869, ASTM F400, US CPSC).

Don't risk it, buy a BIC® lighter!



BIC® is number one worldwide for branded lighters.*



100% of lighters are manufactured by BIC in Europe. All BIC® Lighters are made in BIC factories. This is the starting block of the BIC® lighter safety guarantee.

50 YEARS

BIC has acquired 50 years of incredible manufacturing expertise to guarantee the safety and quality of its products.

50 CHECKS

Before leaving the factory, every BIC® Lighter undergoes more than 50 automatic quality and security checks.

FR
BIC® est le numéro un mondial des briquets de marque.

100% des briquets sont fabriqués par BIC en Europe.

BIC a acquis 50 ans d'une incroyable expertise de fabrication afin de garantir la sécurité et la qualité de ses produits.

Avant de quitter l'usine, chaque briquet BIC® subit plus de 50 contrôles automatiques de qualité et de sécurité.

DE
BIC® ist weltweit die Nummer eins bei Markenfeuerzeugen.

Alle Feuerzeuge von BIC werden zu 100% in BIC-Fabriken in Europa hergestellt.

BIC hat in 50 Jahren eine unglaubliche Fertigungskompetenz erworben und kann somit die Sicherheit und Qualität seiner Produkte gewährleisten.

Jedes BIC® Feuerzeug durchläuft vor Verlassen des Werks über 50 automatische Qualitäts- und Sicherheitskontrollen.

IT
BIC® è il numero uno al mondo fra gli accendini di marca.

Il 100% degli accendini è prodotta BIC in Europa.

BIC ha acquisito 50 anni di incredibile esperienza di produzione per garantire la sicurezza e la qualità dei propri prodotti.

Prima di lasciare la fabbrica, ogni accendino BIC® viene sottoposto a oltre 50 controlli automatici di qualità e sicurezza.

ES
BIC® es el número uno mundial en encendedores de marca.

El 100 % de los encendedores de BIC se fabrica en Europa.

Durante 50 años BIC ha adquirido increíbles conocimientos de fabricación para garantizar la seguridad y calidad de sus productos.

Antes de salir de fábrica, cada encendedor BIC® se somete a más de 50 controles automáticos de calidad y seguridad.

CHOOSE WISELY! BIC® Lighters



**BIC® J25
Lighter**

 UP TO
1450



**BIC® J23
Lighter**

 UP TO
1800



**BIC® J26
Lighter**

 UP TO
3000



**BIC® J38
Lighter**

 UP TO
1800

BIC® LIGHTERS

The iconic, well-loved and time-honoured shapes of BIC® lighters remain on trend!

Four different sizes and a wide range of colour combinations.

FR

Le célèbre briquet BIC®, une icône indémodable, avec un design toujours tendance !

5 tailles différentes et une vaste gamme de combinaisons de couleurs.

IT

L'iconico, amato e intramontabile design dell'accendino BIC® resta di tendenza!

5 diverse misure e una vasta gamma di combinazioni di colori.

DE

Das legendäre, beliebte und bewährte Design des BIC®-Feuerzeugs liegt weiter im Trend!

5 verschiedene Größen und eine breite Farbkombinationspalette.

ES

¡El diseño icónico, querido y atemporal del encendedor BIC® sigue siendo tendencia!

5 tamaños distintos y una amplia gama de combinaciones de colores.



- BIC® J25 LIGHTER**
- BIC® J23 LIGHTER**
- BIC® J26 LIGHTER**
- BIC® J38 LIGHTER**
- BIC® STYL'IT LUXURY CASE**
- BIC® ALUMINIUM FLAT CASE**
- BIC® CLIP CASE**
- BIC® 3D CASE**
- BIC® POCKET ASHTRAY**



BIC® J25 LIGHTER

Perfect for your pocket!

2360 / 2364



Iconic BIC® Boy and BIC® logo engraved!

BIC® J25 LIGHTER

2360

2364 All Black



01

57

57

8G

03

11

59

24

04



25

25

6W

90

02

02

02

02

100%

FR

Parfait pour
votre poche !

DE

Passt perfekt in
die Hosentasche!

IT

Perfetto per
le tue tasche!

ES

¡Perfecto para
tu bolsillo!

Decoration

2360/2364

BIC® J25 LIGHTER
2360/2364
A/C SP: max. 4 col.
MOQ 300 units

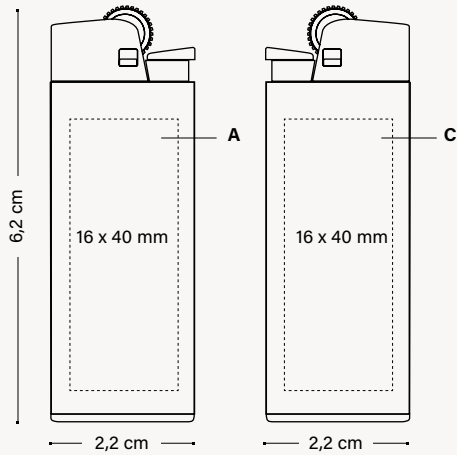

2360/2364

BIC® J25 LIGHTER BRITEPIX™
2360 / 2364
A/C BP: full-colour

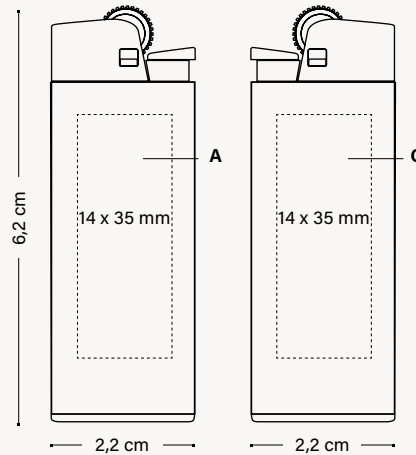

PACKAGING



STANDARD PACKAGING:
IN TRAY OF 50 UNITS

100% recycled!

EXTERNAL PACKAGING



600 ± 76 KG



FSC AND
RECYCLABLE
CARDBOARD



PRINTING TECHNIQUES



SUSTAINABILITY



100% ELECTRICITY COMING FROM RENEWABLE SOURCES

DIGITAL FINISHES



BR BRILLIANT



MT MATT

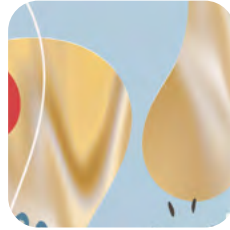

H HOLOGRAPHIC SILVER GOLD



P PUFFY



M METALLIC



UV UV



PG PUFFY GLITTER

2360

BIC® J25 DIGITAL LIGHTER 2360



MT MATT

P PUFFY



PG PUFFY GLITTER



MT MATT

M METALLIC

2360

BIC® J25 DIGITAL LIGHTER

2360

A DG: full-colour

MOQ 600 units

Decoration

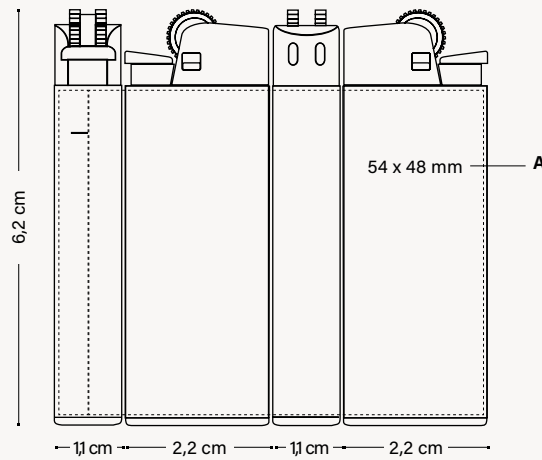

MANUFACTURED AND PRINTED IN BIC FACTORIES



MADE IN SPAIN



PASTEL
MADE IN FRANCE



REGULATORY COMPLIANCE



UP TO 1.450

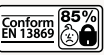

PRINTING TECHNIQUES



DIGITAL

SUSTAINABILITY



100% ELECTRICITY COMING FROM RENEWABLE SOURCES

PACKAGING



100% recycled!

STANDARD PACKAGING:
IN TRAY OF 50 UNITS

EXTERNAL PACKAGING



600 ± 76 KG



FSC AND RECYCLABLE CARDBOARD

See pages 274-277 for a detailed explanation of the icons

BIC® J23 LIGHTER



Iconic BIC® Boy
and BIC® logo
engraved!

2340

BIC® J23 LIGHTER
2340



57



12



03



10

*Slim and fits
everywhere!*



05



04



25



02

2340

BIC® J23 LIGHTER

2340

A/C SP: max. 4 col.

MOQ 300 units

Decoration

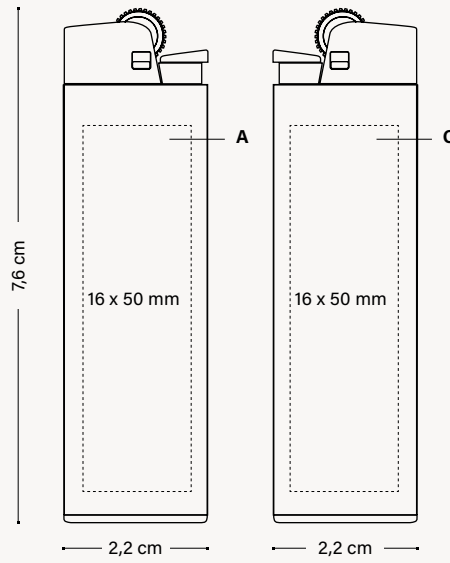

PRINTING TECHNIQUES



SCREEN PRINTING

SUSTAINABILITY



PACKAGING



100% recycled!

STANDARD PACKAGING:
IN TRAY OF 50 UNITS

EXTERNAL PACKAGING



600 ± 9,5 KG



FSC AND
RECYCLABLE
CARDBOARD

See pages 274-277 for a detailed explanation of the icons

DIGITAL FINISHES



BR BRILLIANT



MT MATT

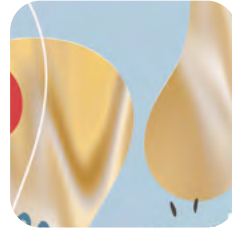

H HOLOGRAPHIC SILVER GOLD



P PUFFY



M METALLIC



UV UV



PG PUFFY GLITTER

2340

BIC® J23 DIGITAL LIGHTER
2340



MT MATT



PG PUFFY GLITTER



BR BRILLIANT

H HOLOGRAPHIC GOLD

2340

BIC® J23 DIGITAL LIGHTER

2340

A DG: full-colour

MOQ 600 units

Decoration

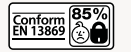
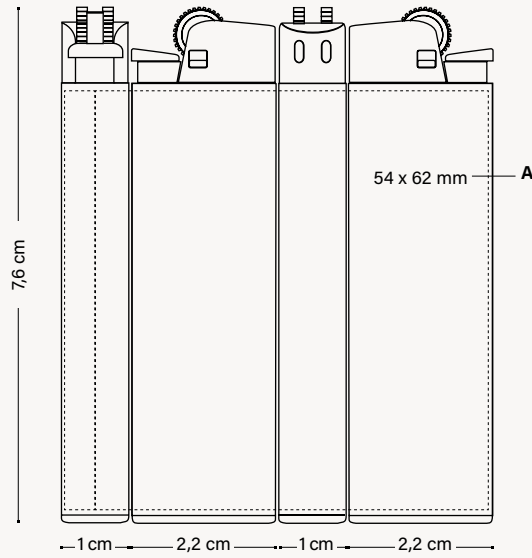

PRINTING TECHNIQUES



PACKAGING



100% recycled!

STANDARD PACKAGING:
IN TRAY OF 50 UNITS

EXTERNAL PACKAGING



600 ± 9,5 KG



FSC AND
RECYCLABLE
CARDBOARD

See pages 274-277 for a detailed explanation of the icons

BIC
GRAPHIC

BIC®
WRITING INSTRUMENTS

OTHER WRITING
INSTRUMENTS

NOTEBOOKS

BIC® / JEEP® LIGHTERS
AND BIC® CASES

BIC®
PACKAGING

GENERAL
INFORMATION

BIC® J26 LIGHTER

The flame that lasts.



Iconic BIC® Boy and BIC® logo engraved!

2320

BIC® J26 LIGHTER

2320



01



57



8G



10



6W

100%

Extra long-lasting: up to 3.000 lights!



59



24



25



02



03

FR
La flamme qui dure.

DE
Die Flamme, die anhält.

IT
La fiamma che dura.

ES
El encendido que dura.

2320

BIC® J26 LIGHTER

2320

A/C SP: max. 4 col.

MOQ 300 units

Decoration

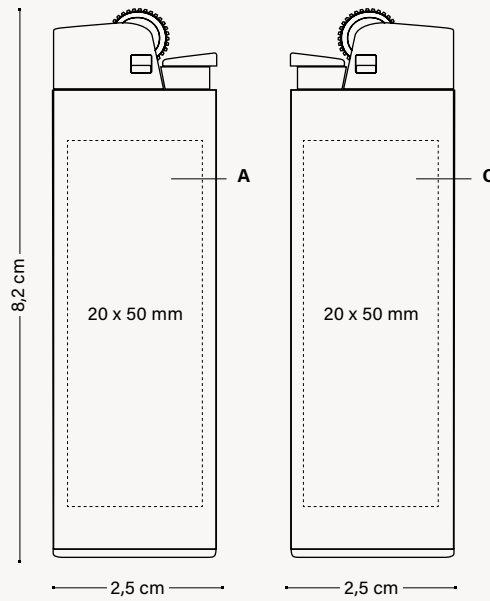

PRINTING TECHNIQUES



SUSTAINABILITY



100% ELECTRICITY COMING FROM RENEWABLE SOURCES

PACKAGING



100% recycled!

STANDARD PACKAGING:
IN TRAY OF 50 UNITS

EXTERNAL PACKAGING



600 ± 15,1 KG



FSC AND RECYCLABLE CARDBOARD

See pages 274-277 for a detailed explanation of the icons

DIGITAL FINISHES



BR BRILLIANT



MT MATT

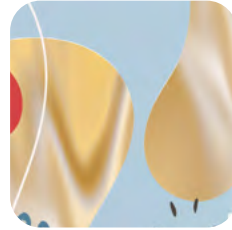

H HOLOGRAPHIC SILVER GOLD



P PUFFY



M METALLIC



UV UV



PG PUFFY GLITTER

2320

BIC® J26 DIGITAL LIGHTER
2320



MT MATT

H HOLOGRAPHIC SILVER



BR BRILLIANT



360°
Printing

MT MATT

100%

2320

BIC® J26 DIGITAL LIGHTER

2320

A DG: full-colour

MOQ 600 units

Decoration

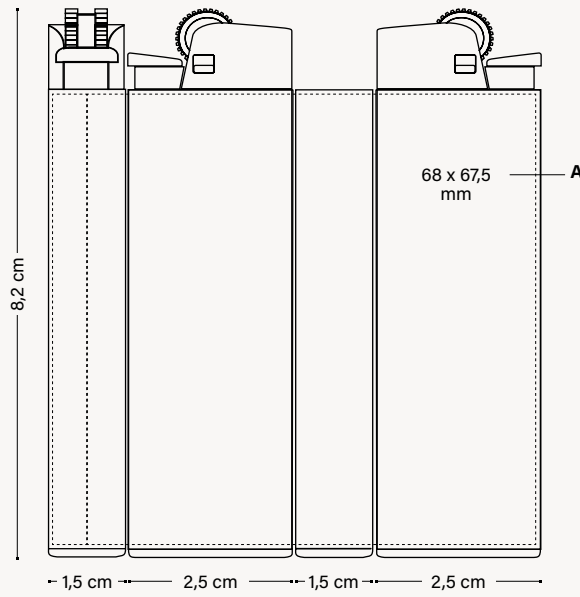

PRINTING TECHNIQUES



SUSTAINABILITY



100% ELECTRICITY COMING FROM RENEWABLE SOURCES

PACKAGING



100% recycled!

STANDARD PACKAGING:
IN TRAY OF 50 UNITS

EXTERNAL PACKAGING



600 ± 15,1 KG



FSC AND
RECYCLABLE
CARDBOARD

See pages 274-277 for a detailed explanation of the icons

BIC® J38 LIGHTER

2452



Iconic BIC® Boy
and BIC® logo
engraved!

BIC® J38 LIGHTER
2452



57



25



02



03

100%

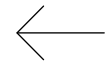

*Elegant and
comfortable
lighting!*

2452

BIC® J38 LIGHTER

2452

A/C SP: max. 4 col.

MOQ 300 units

Decoration

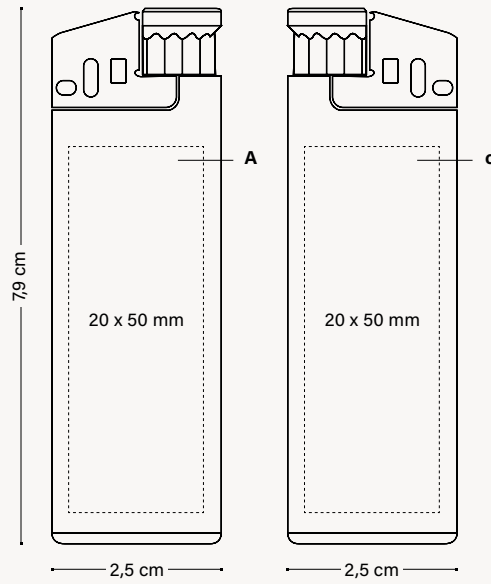

PRINTING TECHNIQUES



SUSTAINABILITY



100% ELECTRICITY COMING FROM RENEWABLE SOURCES

PACKAGING



100% recycled!

STANDARD PACKAGING:
IN TRAY OF 50 UNITS

EXTERNAL PACKAGING



600 ± 13,2 KG



FSC AND RECYCLABLE CARDBOARD

See pages 274-277 for a detailed explanation of the icons

FINISHES



BR BRILLIANT



MT MATT

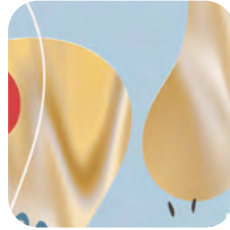

H HOLOGRAPHIC SILVER GOLD



P PUFFY



M METALLIC



UV UV



PG PUFFY GLITTER

2452

BIC® J38 DIGITAL LIGHTER
2452



57

BR BRILLIANT



57

MT MATT



360°
Printing

100%

57

MT MATT

H HOLOGRAPHIC GOLD

2452

BIC® J38 DIGITAL LIGHTER

2452

A DG: full-colour

MOQ 600 units

Decoration

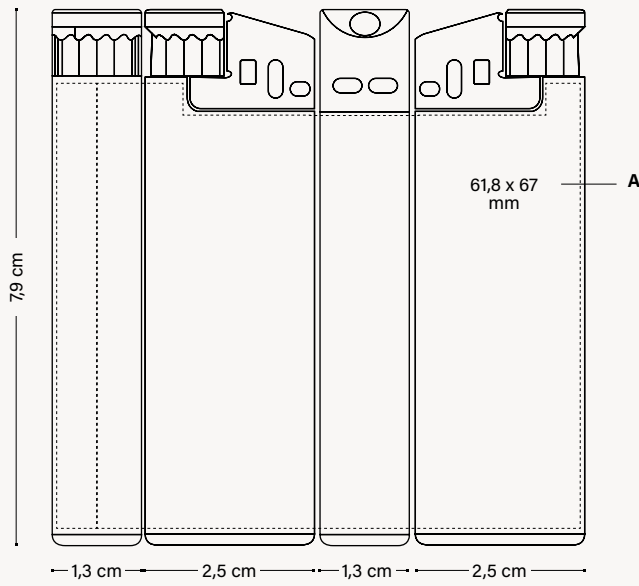

100% ELECTRICITY COMING FROM RENEWABLE SOURCES

PACKAGING



100% recycled!

STANDARD PACKAGING:
IN TRAY OF 50 UNITS

EXTERNAL PACKAGING



600 ± 13,2 KG



FSC AND
RECYCLABLE
CARDBOARD

See pages 274-277 for a detailed explanation of the icons

BIC
GRAPHIC

BIC®
WRITING INSTRUMENTS

OTHER WRITING
INSTRUMENTS

NOTEBOOKS

BIC® / DEEP® LIGHTERS
AND BIC® CASES

BIC®
PACKAGING

GENERAL
INFORMATION

BIC® STYL'IT LUXURY CASE

2386

BIC® STYL'IT LUXURY CASE
2386 Neon



All cases are delivered with a white BIC® 125 lighter!



59



1G



5C

100%

2386

BIC® STYL'IT LUXURY CASE
2386

Decoration

MOQ 100 units
A/C LE

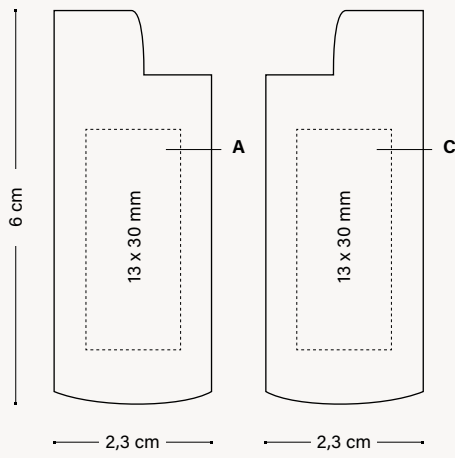

MOQ 100 units
A/C PD

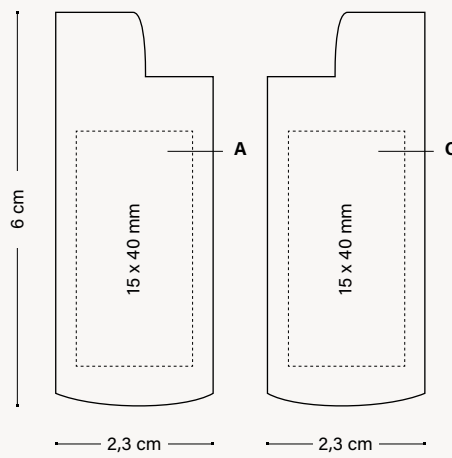

PACKAGING



STANDARD PACKAGING:
BOX FOR 10 UNITS

EXTERNAL PACKAGING



300 ± 6,1 KG



FSC AND
RECYCLABLE
CARDBOARD



PRINTING
TECHNIQUES



PAD PRINTING



LASER

SUSTAINABILITY



See pages 274-277 for a detailed explanation of the icons

BIC® ALUMINIUM FLAT CASE

2156

BIC® ALUMINIUM FLAT CASE
2156

3 customisable sides!

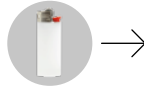

All cases are delivered with a white BIC® J25 lighter!



47

Decoration

2156

BIC® ALUMINIUM FLAT CASE
2156

MOQ 100 units
A/C PD: max. 1 col.

MOQ 100 units
A/B/C BP: full-colour

MOQ 100 units
A/B/C LE

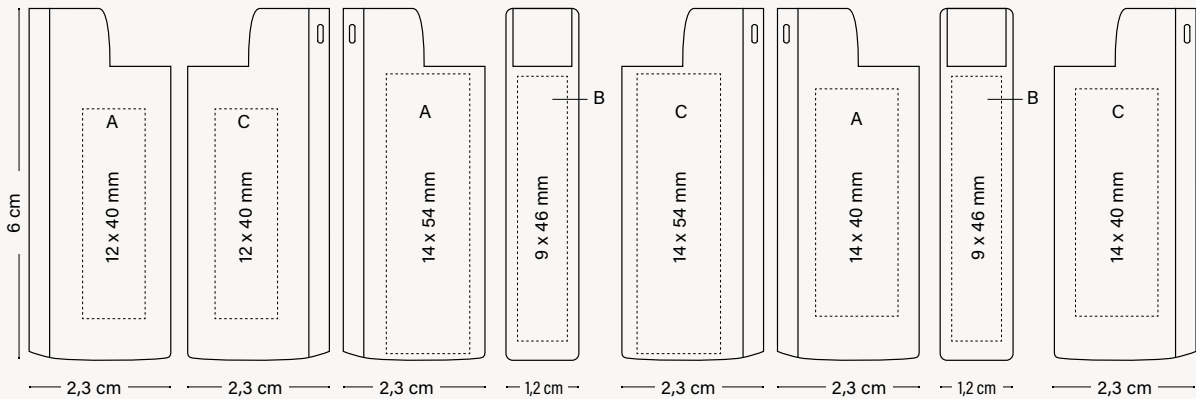

PACKAGING



STANDARD PACKAGING:
BOX FOR 50 UNITS

EXTERNAL PACKAGING



300 ± 75 KG



FSC AND
RECYCLABLE
CARDBOARD



PRINTED IN
BIC FACTORIES

Conform
ISO 9994



REGULATORY
COMPLIANCE

Conform
EN 13869 85%

PRINTING TECHNIQUES

PD

PAD PRINTING

BP

BRITEPIX™
BRITEPIX™ PERSONALISATION

LE

LASER

SUSTAINABILITY

IMPRIM'VERT®

BIC® CLIP CASE

2398

BIC® CLIP CASE
2398



All cases are delivered with a white BIC® J2S lighter!



03

02

100%

Decoration

2398

BIC® CLIP CASE
2398

MOQ 100 units
A/C PD: max. 1 col.

MOQ 100 units
A/C BP: full-colour
BP Texture: full-colour

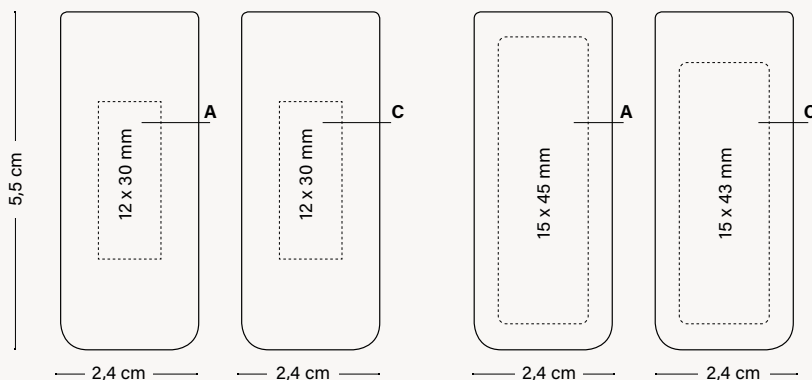

PACKAGING



STANDARD PACKAGING:
BOX FOR 50 UNITS

EXTERNAL PACKAGING



300 ± 75 KG



FSC AND
RECYCLABLE
CARDBOARD



PRINTED IN
BIC FACTORIES



REGULATORY
COMPLIANCE



PRINTING TECHNIQUES

PD

PAD PRINTING

BP

BRITEDIPIX™
BRITEDIPIX™ PERSONALISATION

SUSTAINABILITY



2395

BIC® 3D CASE
2395



↑
All cases are delivered with a white BIC® J25 lighter!



↑
Convert your logo into a 3D shape!

2395

BIC® 3D CASE

2395

A/C 3D: max. 6 col.

MOQ 1.200 units

Decoration



REGULATORY COMPLIANCE

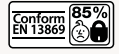

PRINTING TECHNIQUES



EMBOSSING

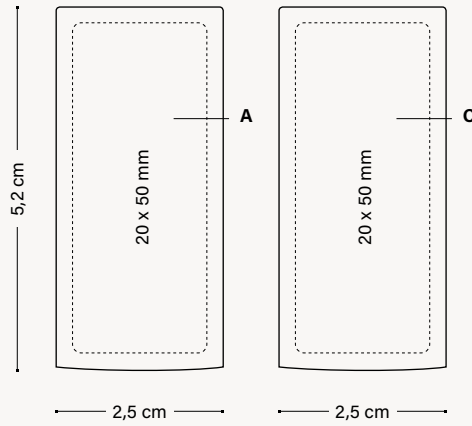

PACKAGING



STANDARD PACKAGING:
BOX FOR 50 UNITS

EXTERNAL PACKAGING



300 ± 75 KG



FSC AND
RECYCLABLE
CARDBOARD

See pages 274-277 for a detailed explanation of the icons

BIC® EZ REACH™

NEW!

Light up unique moments.



FR
Illuminez vos moments uniques.

DE
Entfachen Sie einzigartige Momente.

IT
Illumina momenti unici.

ES
Ilumina momentos únicos.

The safe flame occasions are endless with the new BIC® EZ Reach™.



FR
Les occasions de profiter d'une flamme en toute sécurité sont infinies, grâce au nouveau BIC® EZ Reach™.

DE
Es gibt unzählige Möglichkeiten, mit dem neuen BIC® EZ Reach™ eine sichere Flamme zu entzünden.

IT
Le occasioni per usare una fiamma sicura sono infinite con il nuovo BIC® EZ Reach™.

ES
Las ocasiones para una llama segura son infinitas con el nuevo BIC® EZ Reach™.

BIC® EZ REACH™



SAFETY FLAME

Helps keep fingers away from the flame



Long lasting with up to 900 flames

Stable flame

thanks to the pure isobutane gas



Convenient format

Easily fits in the pocket



Made in Europe



Convenient for different flame occasions



Safe & Reliable



Keeps fingers away from the flame

thanks to its 3.5 cm wand

High force ignition system



Made with 100% electricity coming from renewable sources

High resistance

Made of high mechanical resistance resin Delrin®

FR

FLAMME SÛRE.
Les doigts restent éloignés de la flamme.

DE

SICHERHEITS-FLAMME.
Hilft die Finger von der Flamme fernzuhalten.

IT

FIAMMA DI SICUREZZA.
Aiuta a tenere le dita lontane dalla fiamma.

ES

LLAMA SEGURA.
Ayuda a mantener los dedos alejados de la llama.

NEW!

The most special moments begin when someone lights the flame.



2450

BIC® EZ REACH™

2450

A SP: max. 1 col.

B BP: full-colour

MOQ 240 units



01

02

03



12

25

04

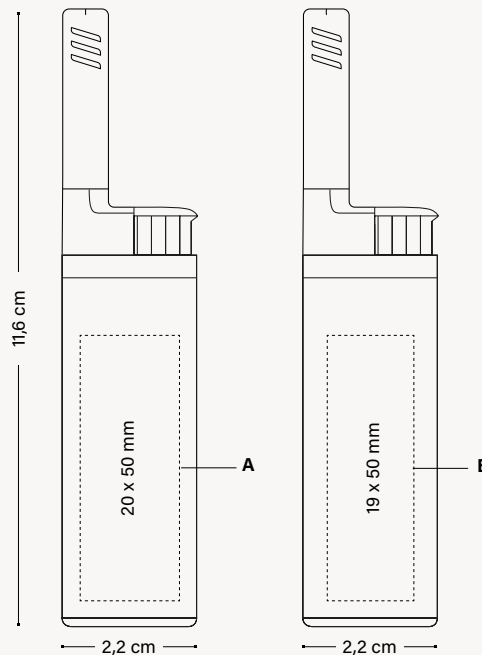

Decoration



MANUFACTURED AND PRINTED IN BIC FACTORIES



MADE IN EUROPE



REGULATORY COMPLIANCE



UP TO 900



Conform ISO 22702



Conform 85%



KEEP FINGERS AWAY FROM THE FLAME



EASILY FITS IN THE POCKET

PRINTING TECHNIQUES



SCREEN PRINTING



BRITEPIX™

SUSTAINABILITY



100% ELECTRICITY COMING FROM RENEWABLE SOURCES

PACKAGING



STANDARD PACKAGING:
IN TRAY OF 20 UNITS

EXTERNAL PACKAGING



120 ± 3.05 KG



FSC AND RECYCLABLE CARDBOARD

FR

Les moments les plus particuliers commencent lorsque quelqu'un allume la flamme.

DE

Die besonders schönen Momente beginnen, wenn jemand die Flamme entzündet.

IT

I momenti più speciali iniziano quando si accende una fiamma.

ES

Los momentos más especiales comienzan cuando alguien enciende la llama.

See pages 274-277 for a detailed explanation of the icons

BIC® POCKET ASHTRAY

3850

BIC® POCKET ASHTRAY
3850

6 different
flap shapes
available!

Reusable and
hermetic!



Decoration

3850

BIC® POCKET ASHTRAY
3850

A SP: max. 5 col. (max. 2 col.
for orders under 20.000 pcs.)

MOQ 5.000 units

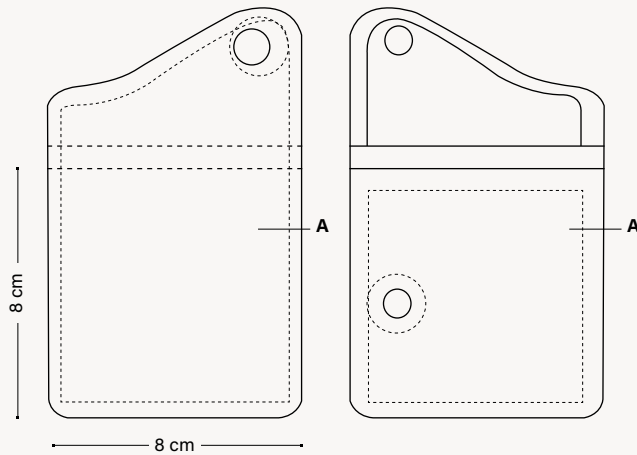

PACKAGING



BOX FOR 10 UNITS EACH
BIC® POCKET ASHTRAY
COMES IN AN INDIVIDUAL
CELLOPHANE PACKAGING

EXTERNAL PACKAGING



500 ± 5,5 KG



REGULATORY
COMPLIANCE

PRINTING TECHNIQUES

SP SCREEN PRINTING

3851

BIC® POCKET ASHTRAY
3851 Kraft



6F

Decoration

3851

BIC® POCKET ASHTRAY KRAFT
3851 Kraft

A SP: max. 2 col.

MOQ 10.000 units

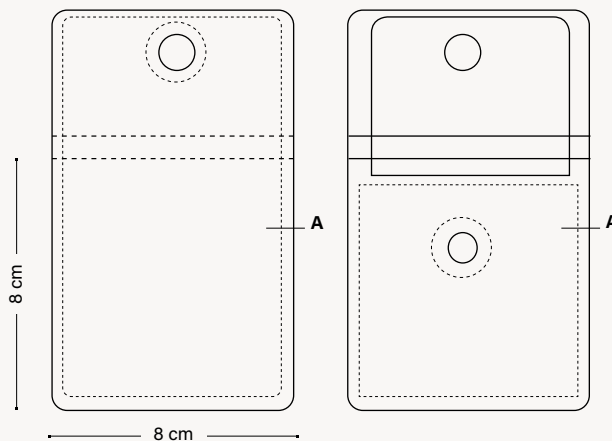

PACKAGING



BOX FOR 10 UNITS EACH
BIC® POCKET ASHTRAY
COMES IN AN INDIVIDUAL
CELLOPHANE PACKAGING.

EXTERNAL PACKAGING



500 ± 5,5 KG



REGULATORY
COMPLIANCE

PRINTING TECHNIQUES



SCREEN PRINTING

DJEEP® LIGHTERS

Long-lasting and designed with style.
DJEEP® is crafted to function perfectly.
Each lighter is fully tested to ensure it
meets our top-quality criteria.

FR

Durable et conçu avec style. Le briquet DJEEP® est créé pour fonctionner parfaitement. Chaque briquet est entièrement testé pour s'assurer qu'il répond à nos critères de qualité les plus stricts.

IT

Di lunga durata e progettato con stile. Ogni accendino è completamente testato per garantire che soddisfi i nostri criteri di massima qualità.

DE

Langlebig und stilvoll gestaltet. DJEEP® ist so konzipiert, dass es perfekt funktioniert. Jedes Feuerzeug wird eingehend getestet, um sicherzustellen, dass es unsere hohen Qualitätskriterien erfüllt.

ES

Duradero y diseñado con estilo. DJEEP® está diseñado para funcionar a la perfección. Cada encendedor se somete a pruebas exhaustivas para garantizar que cumple nuestros criterios de máxima calidad.



DJEEP® D1 LIGHTER





**Ignite your
mark.**

We are
premium

We are
singular



We are
engaged

We are
creative

DJEEP® D1 LIGHTER

Long-lasting and designed with style. DJEEP® is crafted to function perfectly. Each lighter is fully tested to ensure it meets our top-quality criteria.



STABLE FLAME

thanks to pure isobutane fuel



A LONG-LASTING LIGHTER

thanks to triple-tank technology



HIGH RESISTANCE

reservoir made of high mechanical resistance resin



LARGER PUSHER

for a better comfort of use



HIGH-END EFFECTS

QUALITY MADE
compliant with international safety standards. Made in France



UNIQUE RECTANGULAR SHAPE

to offer comfort in hand and a large surface of expression

CHILD-RESISTANT SAFETY GUARD

compliant with EN 13869 Standard

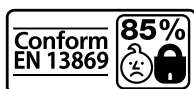

FR
Flamme stable.
Grand poussoir.
Un briquet conçu pour durer.
Effets haut de gamme.
Très résistant.
Forme rectangulaire unique.
Sécurité enfants.

DE
Stabile Flamme.
Großer Drücker.
Ein langlebiges Feuerzeug.
Hochwertige Effekte.
Hohe Widerstandsfähigkeit.
Einzigartige rechteckige Form.
Kindersicherung.

IT
Fiamma stabile.
Pulsante più grande.
Un accendino di lunga durata.
Effetti di alta gamma.
Alta resistenza.
Forma rettangolare unica.
Dispositivo di sicurezza
a prova di bambino.

ES
Llama estable.
Pulsador grande.
Un encendedor de
larga duración.
Efectos de gama alta.
Alta resistencia.
Forma rectangular única.
Protección de seguridad
a prueba de niños.

360° Digital Decoration

DJEEP® offers a wide variety of digital printing effects; select from touch & feel, glossy & matt mix, etched, Holographik®, ... to elevate each lighter.

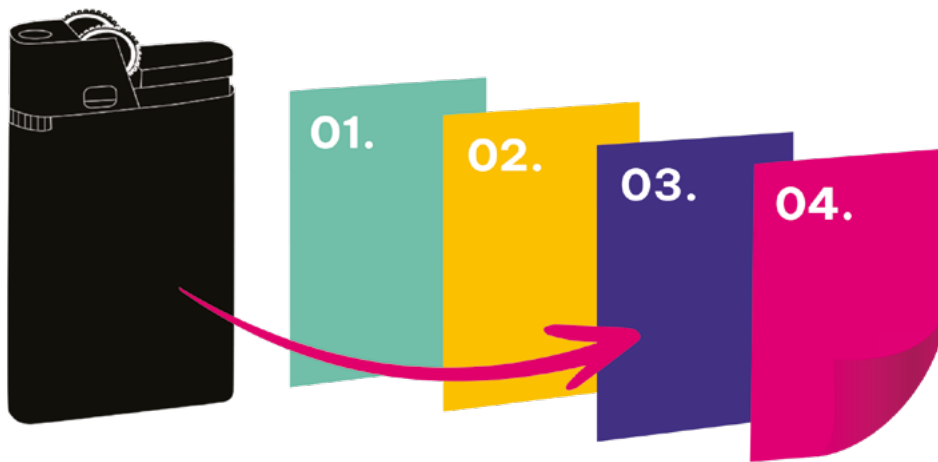

01. Base. Select between:
 WM WHITE MEDIUM M METALLIC SILVER H HOLOGRAPHIK®

02. Printing: We select the best option for you (digital, offset, flexo, silk screen ...) depending on quantity and design options.

03. Finish. Select between:
 G GLOSSY MT MATT ST DJEEP SOFT TOUCH®

04. Decoration options. Select up to 2 different decoration options between:
GRANITE, FABRIC, DJEEP® SOFT TOUCH®, RESIN CHIP, TOUCH&FEEL, GLOSSY & MATT MIX, BLACK LIGHT, HAMMERED METAL, GLITTERING, FRAGRANT INK, GLOW IN THE DARK, ETCHED, QR CODE, HOLOGRAPHIK®, PEARLESCENT.

DECORATION POSSIBILITIES



ST

DJEER® SOFT TOUCH®

Provide a unique smooth sensation!
Deep tones and a soft surface for an exclusive experience.



GT

GLITTERING

Add a sparkling effect to your design!
Make your colours vibrant!



HM

HAMMERED METAL

A metallic background with a puffy effect pattern.
A premium look and feel that stands out!



TF

TOUCH & FEEL

Give an embossed effect to your design!

DECORATION POSSIBILITIES



ET

ETCHED

Gives an etched or engraved effect to the lighter!

Create patterns and convert your idea into an elegant design.



GM

GLOSSY & MATT MIX

Choose this finish to create distinctions between matt or DJEEP® Soft Touch® and the UV varnish that produces vivid colours.



FI

FRAGRANT INK

Rub the label and enjoy the fragrance!

Available fragrances: Mint, Red Fruits, Mojito, Lime and Pineapple.



QR

QR CODE

Redirect your customer to a website, phone number or message. Create interactivity between the lighter and your message!



BL

BLACK LIGHT

Under a black light the fluor colours appear.

You can have light blue, red, green or yellow.

DECORATION POSSIBILITIES



FA

FABRIC

Give it the look and feel of fabric with a relief effect and matt finish!



RC

RESIN CHIP

Add volume to your design! Give the lighter a third dimension!



GR

GRANITE

Add a granular feel to the lighter!



GD

GLOW IN THE DARK

Expose the DJEEP® lighter to a light bulb or direct sunlight and observe the photoluminescent powder in dark places!



H

HOLOGRAPHIK®

A reflective silvery surface to show high quality and innovation!



PE

PEARLESCENT

Pearly and subtle shine that transmits elegance and delicacy!

08D1

DJEEP® D1 LIGHTER 08D1

MOQ 10.000 units
Standard colours combination



**MIX &
MATCH**
No extra charge

Hood

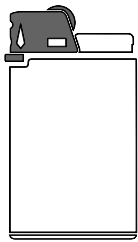

Pusher

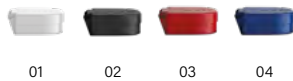
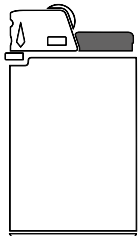

Reservoir

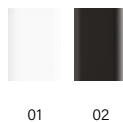
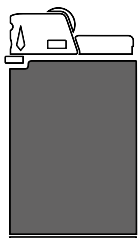

Decoration

08D1

DJEEP® D1 LIGHTER

08D1

A **DG**: full-colour

MOQ 10000 units

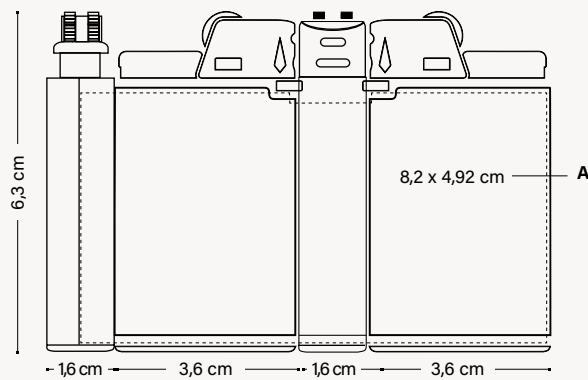

MIX & MATCH



MANUFACTURED AND PRINTED IN DIEEP FACTORIES

FABRIQUÉ EN FRANCE

MADE IN FRANCE



REGULATORY COMPLIANCE



UP TO 3.500

Conform ISO 9994

Conform EN 13869 85%

PRINTING TECHNIQUES



DIGITAL

SUSTAINABILITY



100% ELECTRICITY COMING FROM RENEWABLE SOURCES

PACKAGING



STANDARD PACKAGING:
IN TRAY OF 10 UNITS

Recyclable cardboard

EXTERNAL PACKAGING



600 ± 20 KG



FSC AND RECYCLABLE CARDBOARD

BIC[®] PACKAGING

05

BIC® Packaging Evolutions®	262
BIC® Packaging	264

529294

BIC® COLLECTION BOX SLIM PENS 4 UNITS

FSC cardboard box, customisable on each side and offering large communication surfaces. Ideal for offering our iconic BIC® products as a collection. More than a box, a great way to optimise your sales.



NEW!



Special packaging for:



- BIC® CRISTAL® EXPRESSION**
- BIC® ROUND STIC®**
- BIC® STYLE**
- BIC® CLIC STIC**

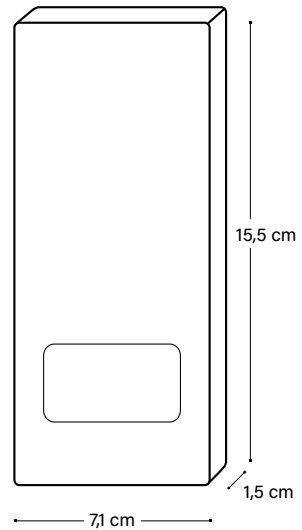

100% customisable from 250 units!

991212 / 991213 / 991214

BIC® COLLECTION BOX

FSC cardboard box, customisable on each side and offering large communication surfaces. Ideal for offering our iconic BIC® products as a collection. More than a box, a great way to optimise your sales.



- 991212 - 1 unit
- 991213 - 2 units
- 991214 - 3 units

Special packaging for:



- BIC® 4 COLOURS®**
- BIC® WIDE BODY™**
- BIC® SUPER CLIP**
- BIC® BRITE LINER® GRIP**
- BIC® GRIP ROLLER**

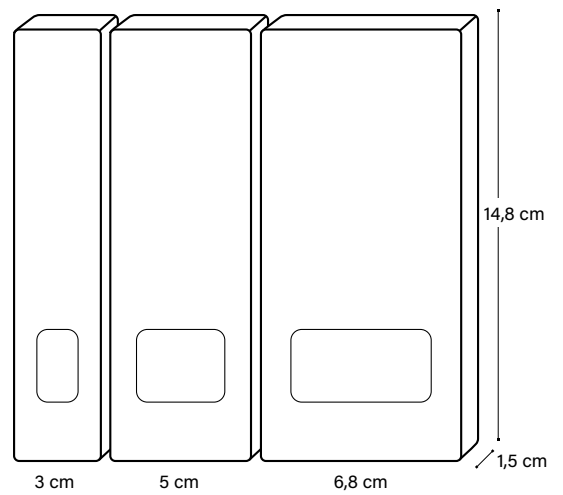

985240

BIC® ECO SLEEVE

Special recycled sleeve for all BIC® writing instruments except graphite pencils.



FSC AND RECYCLABLE CARDBOARD



RECYCLED CARDBOARD

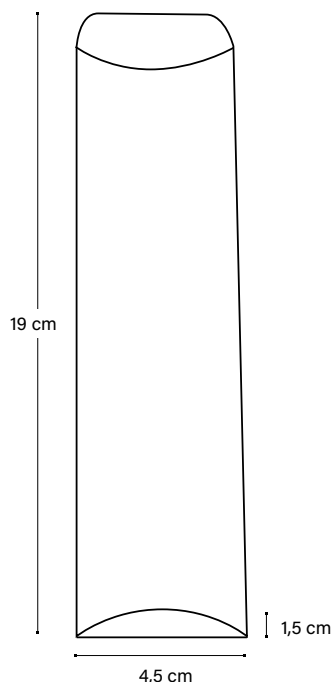

Special packaging for:



- BIC® MEDIA CLIC
- BIC® CLIC STIC
- BIC® SUPER CLIP
- BIC® WIDE BODY™
- BIC® INTENSITY® GEL CLIC
- BIC® XS FINE STYLE



MADE IN SPAIN



REGULATORY COMPLIANCE

SUSTAINABILITY



985241

BIC® WINDOW BOX

Premium design packaging for all BIC® writing instruments except graphite pencils.



FSC AND RECYCLABLE CARDBOARD

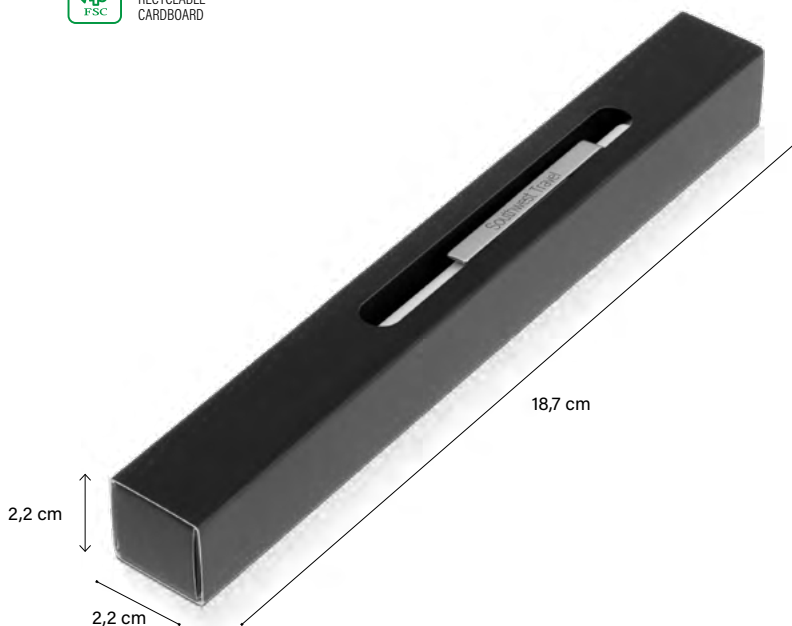

Special packaging for:



BIC® METALLIC PENS

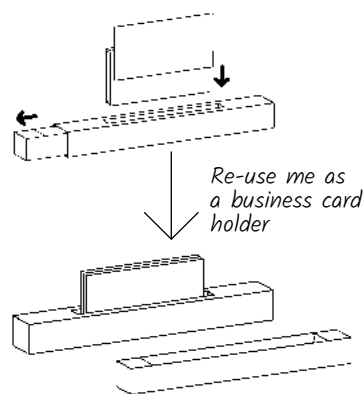

See pages 274-277 for a detailed explanation of the icons

BIC GRAPHIC

BIC WRITING INSTRUMENTS

OTHER WRITING INSTRUMENTS

NOTEBOOKS

BIC / DLEEP LIGHTERS AND BIC CASES

BIC PACKAGING

GENERAL INFORMATION

BIC® PACKAGING

985242

BIC® PLASTIC POUCH

Special design for this packaging which fits any writing instrument or 3 graphite pencils.



Use me as a bookmark

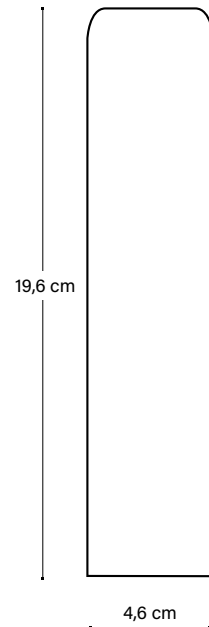

985243

BIC® MARKING SET

Packaging designed for all types of marker products.



Special packaging for:



3 BIC® BRITE LINER® GRIP
3 BIC® MARK-IT



3 BIC® VELLEDA® GRIP
3 BIC® VELLEDA® FINE

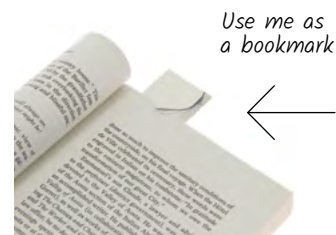

Use me as a bookmark

971634 / 971635 / 971636 / 971637

BIC® CELLO WRAP

Packaging to wrap in a tough and transparent plastic material.

- 971634 - 1 unit
- 971635 - 2 units
- 971636 - 3 units
- 971637 - 4 units



Cello wrap 1 unit



Cello wrap 2 units

974216

BIC® BLACK VELVET POUCH 1 ITEM

Velvet exclusive packaging for 1 writing instrument.
Especially suitable for metal pens.

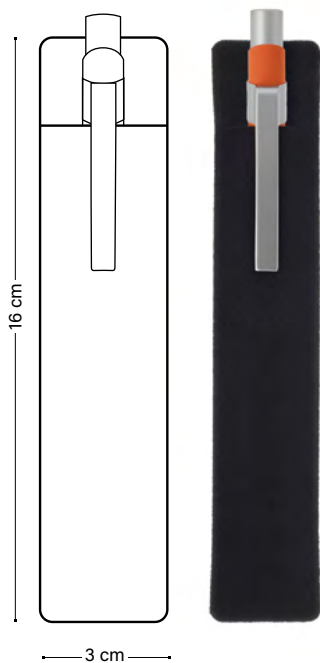

971640

BIC® FROSTED POUCH (FOR 1 OR 2 ITEMS)

Transparent packaging for 2 writing instruments.

A SP: max. 1 col.

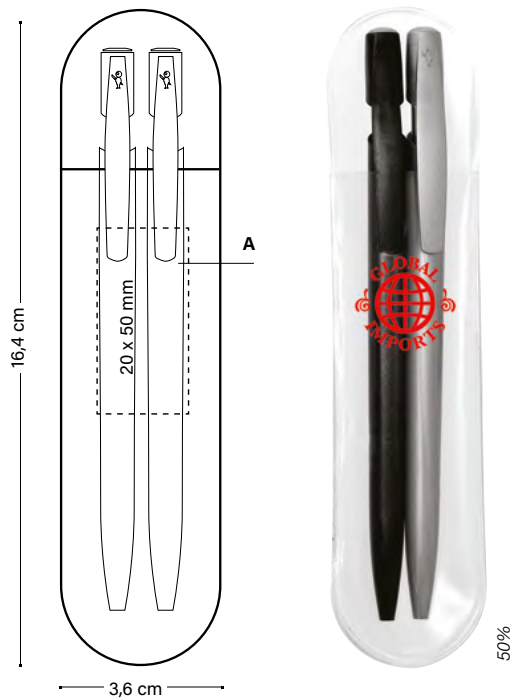

SP SCREEN PRINTING

974599

BIC® SEE-THROUGH GIFT BOX (FOR 1 OR 2 ITEMS)

Box for all writing instruments, except graphite pencils,
with special window.

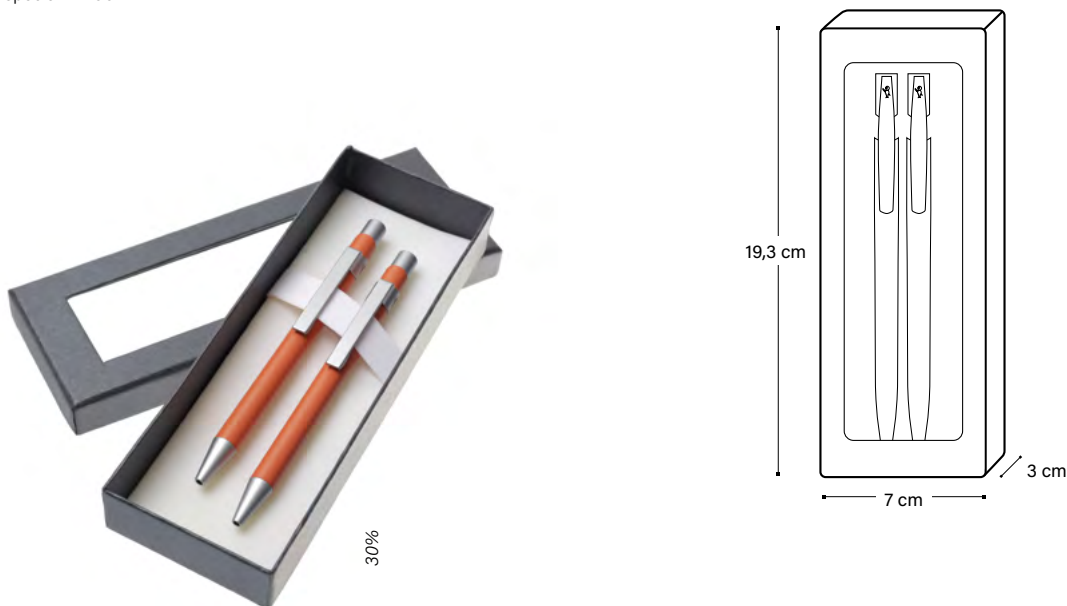

971639 / 971638 / 971672

COUNT BOX

Small (for 25 BIC® Clic Stic) - 6 x 6,2 x 14 cm
971639

Medium (for 50 BIC® Media Clic or writing instruments of similar size) - 7,5 x 7,5 x 15,2 cm
971638

Large (only for 100 BIC® Evolution® Ecolutions®) - 7,5 x 7,5 x 19 cm
971672



971644 / 971643 / 971642

PLASTIC BAG

Small (for 25 BIC® Media Clic or writing instruments of similar size)
971644 - 12 x 18 cm

Medium (for 50 BIC® Media Clic or writing instruments of similar size)
971643 - 15 x 22 cm

Large (for 100 BIC® Media Clic or writing instruments of similar size)
971642 - 30 x 40 cm



974590

TRAY OF 10 WRITING INSTRUMENTS

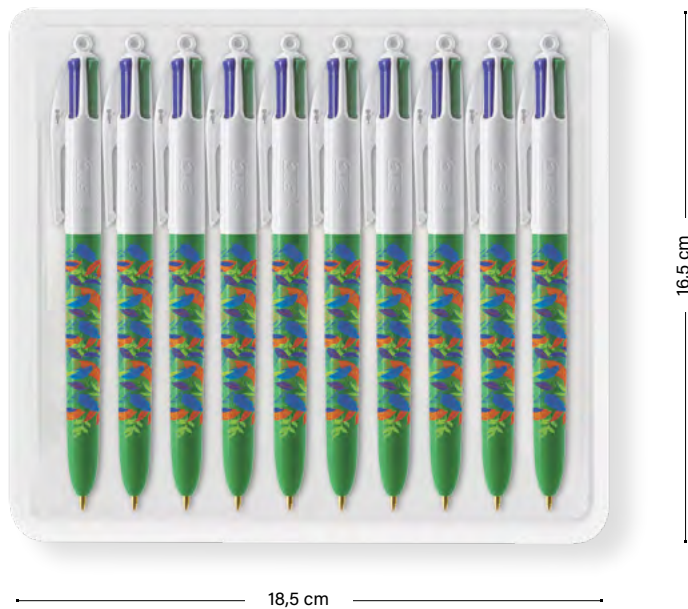

976382

COUNT BOX 10U. CASES



976403

COUNT BOX 10U. CASES CHILD RESISTANT



974635

COUNT BOX 10U. J25 CHILD RESISTANT



977852

BOX OF 50U. METAL STYL'IT CASE



TRAY OF 50 BIC® LIGHTERS



TRAY OF 20U. BIC® EZ REACH™ LIGHTERS



TRAY OF 10 DJEEP® LIGHTERS

RECYCLABLE CARDBOARD



BIC® OUTER BOXES

Special design for all the outer boxes for all writing instruments.



BIC® OUTER BOXES

Special design for lighters outer boxes.



DJEEP® OUTER BOXES

Special design for lighters outer boxes.



GENERAL INFORMATION

Make it simple!	270
Symbols and abbreviations	274
General information	278
Product index	279
Colour table	280

SAVE TIME WHEN CALCULATING YOUR FINAL PRICE

LOOK AT THE QUANTITY COLUMN FOR THE PRICE AND THAT'S IT!



NO SET UP OR SCREEN CHARGES

PERSONALISATION INCLUDED

Price includes personalisation in one position.

CUSTOM MADE COLOURS FOR TRIM

- An "unlimited" choice of barrel and trim colours for orders over 10,000 units.
- A completely personalised pen in any colour you want.
- Available on an extensive range of products.
- A value added service with only a short additional lead time.
- Available for barrel and trims of: BIC® Round Stic®, BIC® Media Clic, BIC® Media Clic Grip*, BIC® Clic Stic, BIC® Super Clip, BIC® Wide Body™, BIC® XS Finestyle

*For personalised barrel and grip MOQ is 20,000 units

OTHER CHARGES

*Not available for digital lighters with Puffy, Puffy Glitter, Metallic, Holographic and UV finishes.

**britePix™ individual personalisation allows you to change the texts and images of your artwork, giving you a personalised imprint for each of the products in your order. Both texts and information regarding image changes should be provided in an Excel file. Should you also require changes in the positioning of the texts and images there will be an additional charge.

Terms and conditions of sale apply, please refer to www.bicgraphic.com

FR

GAGNEZ DU TEMPS LORS DU CALCUL DE VOTRE PRIX FINAL

REGARDEZ LA COLONNE DE QUANTITÉ POUR LE PRIX ET C'EST TOUT !

SANS FRAIS TECHNIQUES NI FRAIS D'ÉCRAN PERSONNALISATION INCLUSE

- Les prix comprennent la personnalisation sur une position.

COULEUR PANTONE POUR LES ATTRIBUTS

- Un choix "illimité" de couleurs de corps et d'attributs à partir de 10.000 pièces.
- Un stylo entièrement personnalisé dans les couleurs que vous souhaitez.
- Disponible avec une large gamme de produits.
- Un service supplémentaire à forte valeur ajoutée avec un court délai additionnel de production.
- Disponible pour les corps et attributs de : BIC® Round Stic®, BIC® Media Clic, BIC® Media Clic Grip®, BIC® Clic Stic, BIC® Super Clip, BIC® Wide Body™, BIC® XS Finestyle

* Pour un corps et grip personnalisés MOQ de 20.000 pièces.

COÛTS SUPPLÉMENTAIRES

* Non disponible pour les briquets numériques avec finitions Puffy, Puffy Glitter, Metallic, Holographic et UV.

** britePix™ personnalisation individuelle vous permet de changer les textes et image de votre photomontage, vous offrant un marquage personnalisé sur chacun des produits de votre commande. Toute information ou image devra être fournie sous un fichier Excel. En cas de modification de la position des textes et images (par rapport à la zone standard) un supplément sera facturé.

Pour les conditions générales de vente, veuillez vous référer à www.bicgraphic.com

IT

RISPARMIA TEMPO QUANDO CALCOLI IL PREZZO FINALE

GUARDA LA COLONNA QUANTITÀ E HAI GIÀ IL TUO PREZZO!

NESSUN COSTO DI IMPIANTO PERSONALIZZAZIONE INCLUSA

- Il prezzo comprende la personalizzazione in una posizione.

COLORI SPECIALI PER I COMPONENTI

- Una illimitata scelta di colori per il corpo e i particolari delle tue penne per ordini a partire da 10.000 pezzi.
- Una penna completamente personalizzata con qualsiasi colore desiderato.
- Disponibile su un'ampia gamma di prodotti.
- Un servizio di grande valore con solo un piccolo aumento dei tempi di produzione.
- Disponibile per fusto e particolari di: BIC® Round Stic®, BIC® Media Clic, BIC® Media Clic Grip®, BIC® Clic Stic,

BIC® Super Clip, BIC® Wide Body™**, BIC® XS Finestyle.

*MOQ per corpo e grip personalizzati: 20.000 pezzi.

COSTI AGGIUNTIVI

*Non disponibile su accendini digitali con Puffy, Puffy Glitter, Metallic, Holographic e finiture UV.

**La personalizzazione individuale in britePix™ consente di modificare i testi e le immagini della vostra bozza dando una stampa personalizzata per ciascuno dei prodotti nel vostro ordine. Sia i testi sia le informazioni relative alle modifiche di immagini dovranno essere forniti in un file Excel. In caso di cambiamenti nel posizionamento dei testi e delle immagini, è previsto un costo aggiuntivo.

Per termini e condizioni di vendita consultare gentilmente: www.bicgraphic.com

DE

SPAREN SIE ZEIT BEIM BERECHNEN IHRER PREISE

NEHMEN SIE EINFACH DIE ENTSPRECHENDEN STAFFELPREISE – DAS WAR'S!

KEINE EINRICHTUNGS- ODER SIEBKOSTEN PERSONALISIERUNG INBEGRIFFEN

- Preise inklusive Personalisierung an einer Position.

SONDEREINFÄRBUNG VON AUSSTATTUNGSELEMENTEN

- Unbegrenzte Farbauswahl bei Schaft und Ausstattungselementen für eine Mindestbestellmenge ab 10.000 Stück.
- Ein vollständig personalisierter Kugelschreiber in Ihrer Wunschfarbe.
- Verfügbar für ein umfassendes Sortiment an Produkten.
- Eine hervorragende Serviceleistung bei nur geringfügig längeren Lieferzeiten.
- Verfügbar für Schäfte und Ausstattungselemente von: BIC® Round Stic®, BIC® Media Clic, BIC® Media Clic Grip®, BIC® Clic Stic, BIC® Super Clip, BIC® Wide Body™, BIC® XS Finestyle

*Für personalisierten Schaft und Griffzone liegt die Mindestbestellmenge bei 20.000 Stück.

SONSTIGE KOSTEN

* Nicht verfügbar für digitale Feuerzeuge mit Puffy-, Puffy Glitter-, Metallic-, Holographic- und UV-Oberflächen.

** britePix™ individuelle Personalisierung bietet Ihnen die Möglichkeit, Texte und Abbildungen Ihres Layouts auszutauschen und somit einen individuell personalisierten Druck für jeden einzelnen Artikel Ihres Auftrags zu erhalten. Sie übermitteln uns Text, Logo und alle weiteren Daten in einer Excel-Datei. Falls zusätzlich Positionsänderungen bei Text oder Abbildungen erforderlich sind, fallen Zusatzkosten an.

Es gelten die allgemeinen Verkaufsbedingungen, siehe www.bicgraphic.com

ES

AHÓRRATE TIEMPO CALCULANDO EL PRECIO FINAL

BASTA CON BUSCAR LA COLUMNA DE LA CANTIDAD QUE NECESITAS Y ¡YA ESTÁ!

SIN GASTOS TÉCNICOS NI DE PANTALLA PERSONALIZACIÓN DEL PRODUCTO INCLUIDA

- El precio incluye la personalización en una posición.

COLORES PERSONALIZADOS PANTONE PARA COMPONENTES

- Un gran abanico de colores para el cuerpo y los componentes a partir de 10.000 unidades.
- Un bolígrafo totalmente personalizado en el color deseado.
- Disponible en una amplia gama de best sellers.
- Un servicio de valor añadido en un tiempo de entrega adicional muy reducido.
- Disponible para cuerpo y componentes de: BIC® Round Stic®, BIC® Media Clic, BIC® Media Clic Grip®, BIC® Clic Stic, BIC® Super Clip, BIC® Wide Body™, BIC® XS Finestyle

*Personalizar cuerpo y grip tiene una MOQ de 20.000 unidades.

COSTES ADICIONALES

*No disponible para digital lighters con acabados Puffy, Puffy Glitter, Metallic, Holographic y UV.

**La personalización individual britePix™ te permite cambiar los textos e imágenes de tu dibujo, ofreciéndote una impresión personalizada para cada uno de los productos de tu pedido. Tanto los textos como la información de cambios de las imágenes se deberían facilitar en una hoja Excel. Si se requieren también cambios en la posición de los textos e imágenes, se aplicará un cargo adicional.

Aplicación de los términos y condiciones de venta, por favor consulta www.bicgraphic.com

BIC® GRAPHIC

BIC® WRITING INSTRUMENTS

OTHER WRITING INSTRUMENTS

NOTEBOOKS

BIC® / D/DEEP® LIGHTERS AND BIC® CASES

BIC® PACKAGING

GENERAL INFORMATION

FILE INFORMATION

Please submit your artwork in one of the following formats:

- Electronic file with the graphic design (artwork)
- Separate file for the text. For individual laser engraving please provide texts only in Excel® format (.xls)

ARTWORKS FEATURES

Please submit your artwork in one of the following formats:

- JPG / 350 dpi not compressed (only for images, no texts)
- PDF / outlined
- Illustrator® CC / outlined
- Photoshop® CC / with layers
- ZIP files

In order to facilitate a fluid order process and obtain an appropriate final result, it is important to provide us the information in one of the above listed formats. Should the customer's design not fit into our imprint area, we will modify it accordingly.

TYPEFACES:

All the typefaces must be converted to an artwork. Verify the minimum type sizes & line weights. Please, contact Customer Service for further information.

FR

INFORMATIONS CONCERNANT LES FICHIERS

Envoyez-nous votre matériel graphique dans un des types de fichiers suivants:

- Un fichier électronique avec le dessin graphique
- Et un fichier différent pour le texte. Pour un marquage au laser individuel, les textes devront être fournis uniquement sous format Excel® (.xls)

PROPRIÉTÉS DU MATÉRIEL GRAPHIQUE

Envoyez-nous votre matériel graphique dans un des types de fichiers suivants :

- JPG / 350 dpi non comprimé à la taille réelle de marquage (seulement images, sans texte)
- PDF / vectorisé
- Illustrator® CC / vectorisé
- Photoshop® CC / avec les calques
- Fichiers ZIP

Il est important que vous nous fassiez parvenir les informations dans l'un de ces formats afin de traiter au mieux votre commande et d'obtenir un résultat final optimal. Si la création du client ne rentre pas dans notre format, nous la modifierons en conséquence.

TYPE DE CARACTÈRES :

Tous les types de caractères doivent être convertis en image. Vérifiez les tailles minimales des types et les épaisseurs de trait. Veuillez contacter le service clientèle pour plus d'informations.

IT

INFORMAZIONE SUI FILE:

Sempre, per quanto riguarda i file, i documenti si devono inviare come di seguito:

- un file elettronico con il design grafico (artwork)
- ed un altro file separato per il testo. Per un'incisione a laser singola, consegnare i testi esclusivamente in formato Excel® (.xls)

PROPRIETÀ DEL MATERIALE GRAFICO

Inviatemi il vostro materiale grafico in uno dei seguenti tipi di file:

- JPG / 350 dpi non compresso e nel formato reale della stampa (solo per le immagini, non per il testo)
- PDF / vettoriale
- Illustrator® CC / vettoriale
- Photoshop® CC / con livelli
- file ZIP

E' importante che le informazioni vengano mandate in uno dei formati indicati al fine di sveltire l'ordine ed ottenere un miglior risultato finale. Nel caso in cui il design del cliente non si adattasse all'area di stampa, verrà adattato di conseguenza.

CARATTERI:

Tutti i caratteri devono essere convertiti in immagine. Verificare le dimensioni minime del carattere e gli spessori del tratto.

DE

ANFORDERUNGEN DRUCKUNTERLAGEN

Bitte senden Sie uns folgende Dateien:

- Reprofähige Druckvorlagen als Grafik
- Für eine Lasergravur übermitteln Sie uns bitte Ihre Druckdaten im Excel® Format (.xls)

EIGENSCHAFTEN DRUCKVORLAGEN

Technische Daten der Grafikdateien. Bitte schicken Sie Ihre Grafiken in einem dieser Formate:

- JPG / 350 dpi nicht komprimiert und in der tatsächlichen Druckgröße (nur Bilddaten, kein Text)
- PDF / Vektordatei
- Illustrator® CC / Vektordatei
- Photoshop® CC / mit Ebenen
- ZIP Format

Wir bitten um Zusendung der Daten in den angegebenen Formaten. Damit können wir den Auftrag schnellstmöglich bearbeiten und ein optimales Druckergebnis erreichen. Sofern der Entwurf des Kunden nicht in unseren Druckbereich passt, werden wir ihn entsprechend anpassen.

SCHRIFTARTEN:

Alle Schriftarten müssen in eine Vorlage umgewandelt werden. Überprüfen Sie die Mindestschriftgrößen und Linienstärken. Für weitere Informationen kontaktieren Sie bitte unseren Kundenservice.

ES

INFORMACIÓN SOBRE ARCHIVOS

En cualquier caso, los archivos deben ser dos:

- Un archivo electrónico con el diseño gráfico (creatividad) y otro archivo distinto para el texto
- Para un grabado en láser, facilita los textos únicamente en formato Excel® (.xls)

PROPIEDADES DEL MATERIAL GRÁFICO

Envíanos tu material gráfico en alguno de los siguientes tipos de archivo:

- JPG/ 350 dpi sin comprimir al tamaño real de impresión (sólo imágenes, sin texto)
- PDF / vectorizado
- Illustrator® CC / vectorizado
- Photoshop® CC / con capas
- Archivos ZIP

Es importante que nos proporciones la información en uno de estos formatos para agilizar su pedido y para obtener un resultado final adecuado. Si el diseño del cliente no encajase correctamente en el área de impresión, lo modificaremos consecuentemente.

FUENTES:

Todos los tipos de letra se deben convertir en un arte final. Verifica los tamaños de los tipos mínimos y grosores de línea. Por favor, contacta con Atención al Cliente para más información.

SPECIAL FOR WRITING PRODUCTS

SCREEN PRINTING

SÉRIGRAPHIE
SIEBDRUCK
SERIGRAFIA
SERIGRAFÍA

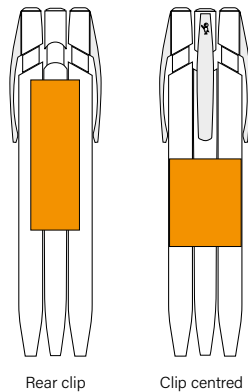

Rear clip

Clip centred



Available imprint area depends on required printing technique.

- FR La zone d'impression disponible dépend de la technique d'impression requise.
- DE Die mögliche Werbeaufdruckfläche ist von der angeforderten Drucktechnik abhängig.
- IT L'area di stampa disponibile dipende dalla tecnica desiderata.
- ES Área de impresión disponible según la técnica de impresión.

SPECIAL FOR DIGITAL LIGHTERS (J25, J23, J26 & J38)

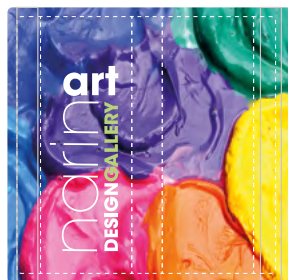
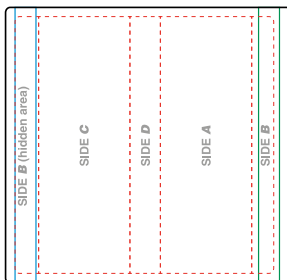























If a direct exact colour is desired a fifth colour may be chosen from the aforementioned Guide for an additional charge. For more information on achieving the closest colour match for imprints on different products within our catalogue please contact our Customer Service Department



















- FR Pour toute demande de couleur directe Pantone, nous pouvons proposer une impression avec une 5ème couleur disponible dans ce catalogue, à un prix majoré. Pour plus d'informations sur la manière d'obtenir la couleur correspondante la plus proche pour des impressions sur différents produits de notre catalogue, veuillez contacter notre service client.
- DE Wenn Sie ausdrücklich eine Pantone-Farbe wünschen, können Sie zusätzlich eine fünfte Farbe aus unserem verfügbaren Repertoire auswählen. Hierfür wird ein Aufpreis berechnet. Weitere Informationen zur Farbangleichung bei Bestellung verschiedener Produkte erhalten Sie von Ihrem Kundenservice.
- IT Se si desidera un colore preciso, potrebbe essere scelto un quinto colore dalla suddetta guida a un costo aggiuntivo. Per maggiori informazioni sulla migliore corrispondenza del colore di stampa per i vari prodotti del nostro catalogo, contattare il nostro Servizio Clienti.
- ES En el caso de querer un color directo, podemos ofrecer la impresión con un 5º color de dicha Guía. Para una mejor coincidencia de colores entre los diferentes productos de nuestro catálogo, ponte en contacto con nuestro departamento de Atención al Cliente.

Symbols and abbreviations

PRINTING TECHNIQUES SYMBOLS

	EN	FR	DE	IT	ES	
	Puffy glitter. Coloured glitter texture.	Puffy glitter Texture avec paillettes colorées.	Puffy Glitter Farbige Glitzer-Textur.	Puffy glitter Texture con glitter colorati.	Puffy glitter Textura de color brillante.	 britePix™
	Puffy. Highlighted personalisation giving a relief effect to your logo.	Puffy Une personnalisation soulignée par notre encre « Puffy », pour donner un effet de relief à votre logo.	Puffy Eine überzeugende Personalisierung mit unserer "Puffy"-Tinte, die Ihrem Logo einen Relief- Effekt verleiht.	Puffy Una personalizzazione evidenziata con il nostro inchiostro "Puffy" per dare un effetto a rilievo al tuo logo.	Puffy Resalta tu personalización dándole efecto relieve a tu logo.	 Embossing FR - 3D embossage / ESP-Relieve 3D / GER-3D-Prägung / IT-3D Rilievo
	Brilliant. Brilliant finish.	Brilliant Finition brillante.	Brilliant Digitaldruck mit Glanzeffekt.	Brilliant Finitura brillante.	Brilliant Acabado brillante.	 Debossing
	Metallic Create metallic effects on images and backgrounds.	Metallic Crée des effets métalliques sur les images ou l'arrière-plan.	Metallic Kreieren Sie Metall-Effekte mit Bildern und Hintergründen.	Metallic Crea effetti, immagini sfondi metallici. Il tuo marchio sarà inconfondibile	Metallic Crea efectos metálicos en imágenes o fondos.	 Touch & feel
	Holografic Create attractive gold or silver effects.	Holografic Crée des effets attractifs en or ou argent.	Holografic Kreieren Sie attraktive Gold- oder Silbereffekte	Holografic Trasforma il tuo logo in un immagine tridimensionale con gli ologrammi. Rende il tuo messaggio straordinario.	Holografic Convierte tu logo en una imagen tridimensional usando hologramas.	 Etched
	Matt Matt finish.	Matt Finition mate.	Matt Digitaldruck mit matter Oberfläche	Matt Finitura opaca.	Matt Acabado mate.	 Fragrant ink
	UV High gloss finish.	UV Finition extra brillante.	UV UV Digitaldruck mit Hochglanzeffekt.	UV Finitura lucida.	UV Acabado super brillante.	 QR code
	Hot Stamping Tactile embossing	Hot Stamping Graver en relief sensible au toucher.	Hot Stamping Folien-Heißprägung	Hot Stamping Rilievo tattile	Hot Stamping Grabado en relieve sensible al tacto.	 Black light
	Print 360° ballpen	Impression 360° degrés	360° Druck auf Kugelschreiber	Stampa a 360° penna a sfera	Print 360° bolígrafo	 Fabric
	Print 360° lighter	Impression 360° degrés	360° Druck auf Feuerzeug	Stampa a 360° accendino	Print 360° encendedor	 Resin chip
	Digital. High-definition 4-colour process. 360° degrees and full length of the barrel/body.	Digital Quadrichromie haute définition. à 360° degrés et sur toute la longueur du corps.	Digital Hochauflösender Vierfarb-Prozess. 360° Rundumdruck auf dem ganzen Schaft.	Digital Alta definizione - stampa in digitale in quadricromia, 360° gradi su tutta la lunghezza del corpo.	Digital Cuatricromía de alta definición. 360° en el cuerpo entero.	 Granite
	britePix™ Digital The solution for full colour communication. Now on coloured barrels!	britePix™ Digital La solution pour une communication tout en couleur. Maintenant sur des corps en couleur.	britePix™ Digital Die Lösung für farbenfrohe Kommunikation Jetzt auch auf farbigen Schäften.	britePix™ Digital La soluzione per la comunicazione a tutto colore. Ora sui fusti colorati.	britePix™ Digital La solución para una impresión a todo color. Ahora en cuerpos de colores.	 Glow in the dark
	britePix™ Texture britePix™ Texture is a fresh addition to our britePix™ concept: now you don't just see the full colour – you can feel it!	britePix™ Texture britePix™ Texture apporte une nouvelle touche haut de gamme au concept britePix™. Désormais, vous pouvez non seulement voir tout en couleur, mais aussi le toucher !	britePix™ Texture britePix™ Texture ist eine neue Ergänzung für unser britePix™ Druckkonzept – man kann die Farben jetzt nicht nur sehen, man kann sie auch fühlen!	britePix™ Texture britePix™ Texture è un salto di qualità nel nostro concetto di stampa britePix™ – ora non solo puoi vedere il colore pieno, ma puoi anche toccarlo!	britePix™ Texture britePix™ Texture es un añadido premium al concepto britePix™ - ahora no sólo puedes verlo sino que ¡también puedes sentirlo!	 Holographik®
	britePix™ personalisation Personalise each unit within the same britePix™ order.	britePix™ personalisation Personnalisez chaque unité dans une seule et même commande.	britePix™ Personalisierung Personalisieren Sie Ihre britePix™-Bestellung. Geben Sie jedem Artikel Ihrer Bestellung eine individuelle Note.	britePix™ personalisation Personalizzazione britePix™. Personalizza ogni unità dello stesso ordine britePix™.	britePix™ personalisation Personalización britePix™. Personaliza cada unidad en el mismo pedido britePix™.	 Pearlescent
	Screen printing	Screen printing	Screen printing	Screen printing	Screen printing	 Djeep® soft touch®
	Laser	Laser	Laser	Laser	Laser	 Glittering
	Pad printing	Pad printing	Pad printing	Pad printing	Pad printing	 Hammered metal
	Digital	Digital	Digital	Digital	Digital	

WRITING MODES















	EN	FR	DE	IT	ES
	Ballpen M Medium 1 mm F Fine	Bille M Medium 1 mm F Fine	Kugelschreiber M Medium 1 mm F Fine	Penna a sfera M Medium 1 mm F Fine	Bolígrafo M Medium 1 mm F Fine
	Mechanical Pencil MP	Porte-mine MP	Druckbleistift MP	Portamine MP	Portaminas MP
	Pencil PC	Crayon PC	Bleistift PC	Matita PC	Lápiz PC
	Roller Ball R	Stylo à bille roulante R	Roller R	Roller R	Roller R
	Highlighter HL	Marqueur HL	Textmarker HL	Evidenziatore HL	Resaltador HL
	Stylus Pen SP	Embout caoutchouc SP	Stylus Pen SP	Stylus Pen SP	Stylus Pen SP
	Finestyle Ø 0,7mm FS	Feutre pointe fine FS Ø 0,7mm	Finestyle-Schreiber Ø 0,7mm FS	Scrittura Finestyle Ø 0,7mm FS	Escritura Finestyle FS Ø 0,7mm
	Gel G	Gel G	Gel-Schreiber G	Gel G	Gel G
	Marker MK	Marqueur pointe ogive MK	Textmarker MK	Pennarello MK	Marcador MK
	Resistant tip	Pointe résistante	Robuste Spitze	Punta resistente	Punta resistente
	No splinter	Pas d'échardes en cas de brisure	Splittert nicht	Non si scheggia	No se astilla
	Easy to use and erase	Facile à utiliser et à effacer	Leichtes Nutzen und Ausradieren	Facile da usare e da cancellare	Fácil de usar y borrar
	Smoother and darker writing	Écriture plus douce et foncée	Leichtes und farbkraftiges Schreiben	Scrittura più delicata e scura	Escritura más suave y oscura
	Smoother, more flowing writing	Écriture plus douce et fluide	Leichtes und flüssiges Schreiben	Scrittura più delicata e fluida	Escritura más suave y fluida
	Shock resistant	Résiste aux chocs	Stoßfest	Resistente agli urti	Resistente a los golpes
	Will not dry out	Ne sèche pas	Trocknet nicht aus	Non si secca	No se seca
	Protective sheath	Protecteur de mine	Minenschutz	Proteggi mina	Protector de mina
	2 leads	2 mines	2 Minen	2 mine	2 minas

INK COLOURS

EN	FR	DE	IT	ES	EN	FR	DE	IT	ES
● Black	Noir	Schwarz	Nero	Negro	● Light Green	Vert clair	Hellgrün	Verde chiaro	Verde claro
● Light Blue	Bleu clair	Hellblau	Azzurro	Azul claro	● Apple Green	Vert pomme	Apfelgrün	Verde	Verde Manzana
● Dark Blue	Bleu foncé	Dunkelblau	Blu	Azul oscuro	● Green Dark	Vert foncé	Dunkelgrün	Verde mela	Verde oscuro
● Red	Rouge	Rot	Rosso	Rojo	● Fluo	Fluo	Fluoreszierend	Fluo	Fluo
● Orange	Orange	Orange	Arancio	Naranja	● Pink	Rose	Rosa	Rosa	Rosa
● Yellow	Jaune	Gelb	Giallo	Amarillo	● Purple	Violet	Violett	Viola	Morado

Symbols and abbreviations

OTHER SYMBOLS

	EN	FR	DE	IT	ES
	New	Nouveau	Neu	Nuovo	Nuevo
	Mix&Match Hundreds of colours of components in stock of writing instruments for full personalisation.	Mix&Match Des centaines de couleurs de composants en stock pour la personnalisation complète des instruments d'écriture.	Mix&Match Hunderte von Farben bei den Schreibgeräte-Komponenten auf Lager. Für eine komplette Personalisierung.	Mix&Match Centinaia di colori dei componenti di produzione degli strumenti di scrittura per una personalizzazione completa	Mix&Match Cientos de componentes de instrumentos de escritura para una completa personalización
	Custom colours Choose the exact PMS colour that suits your logo.	Couleurs personnalisées Choisissez la couleur exacte pour des décorations les mieux adaptées à votre logo.	Sonderfarben Wählen Sie genau die PMS-Farbe, die am besten zu Ihrem Logo passt.	Colori Personalizzati Scegli il colore PMS esatto che si adatta meglio al tuo logo.	Colores personalizados Elija el color exacto PMS que mejor se adapte a su logo.
	Manufactured and printed in BIC factories	Fabriqué et imprimé dans les usines BIC	In BIC-Werken hergestellt und bedruckt	Prodotto e stampato negli stabilimenti BIC	Fabricado e impreso en fábricas BIC
	Manufactured in BIC factories	Fabriqué dans les usines BIC	In BIC-Werken hergestellt	Prodotto negli stabilimenti BIC	Fabricado en fábricas BIC
	Printed in BIC factories	Imprimé dans les usines BIC	In BIC-Werken bedruckt	Stampato negli stabilimenti BIC	Impreso en fábricas BIC
	Assembled and printed in DJEEP factories	Montage et impression dans les usines DJEEP	Montage und Druck in DJEEP-Werken	Assemblaggio e stampa negli stabilimenti DJEEP	Montaje e impresión en fábricas DJEEP
	Assembled and printed in BIC factories	Montage et impression dans les usines BIC	Montage und Druck in BIC-Werken	Assemblaggio e stampa negli stabilimenti BIC	Montaje e impresión en fábricas BIC
	Quality & safety approved	Qualité et sécurité approuvées	Qualität und Sicherheit und genehmigt	Qualità e sicurezza approvata	Calidad y seguridad aprobada
	Country of Origin	Pays d'origine	Herkunftsland	Paese d'origine	País de origen
	Made in France	Fabriqué en France	Hergestellt in Frankreich	Fabbricato in Francia	Fabricado en Francia
	Made in Spain	Fabriqué en Espagne	Hergestellt in Spanien	Prodotto in Spagna	Fabricado en España
	Viral reduction 93% in 24h	Réduction virale 93% en 24h	Reduktion von 93 % der Viren in 24 Std.	93% di riduzione virale entro 24 ore	Reducción viral 93% en 24h
	Entire pen protection	Protection sur toute la surface du stylo	Schutz der Kugelschreiberoberfläche	Protezione della superficie della penna a sfera	Protección de la superficie del bolígrafo
	Timeless protection	Protection à vie	Dauerschutz	Protezione permanente	Protección permanente
	Bacteria elimination	Protection antibactérienne	Schutz vor Bakterien	Protezione batterica	Protección contra las bacterias
	Fungal inhibition for 24h	Inhibition des champignons en 24h	Hemmt Pilzbefall 24 Std.	Inibizione di funghi 24 ore	Inhibición de hongos 24h
	EN 13869 European Child Resistant Regulation for lighters.	EN 13869 Règlement Européen pour briquets avec sécurité pour enfants	EN 13869 Europäische Kindersicherheitsnorm für Feuerzeuge.	EN 13869 Normativa europea per accendini sulla sicurezza dei bambini.	EN 13869 Regulaciones Europeas para encendedores con seguridad para niños.
	Keep fingers away from the flame	Gardez les doigts loin de la flamme	Hält die Finger von der Flamme fern	Tieni le dita lontane dalla fiamma	Manten los dedos lejos de la llama
	Easily fits in the pocket	Se glisse facilement dans la poche	Passt problemlos in die Tasche	Si adatta facilmente alla tasca	Cabe fácilmente en el bolsillo
	Number of flames	Nombre d'allumages	Anzahl der Zündungen	Numero di lame	Número de encendidos

OTHER SYMBOLS

	EN	FR	DE	IT	ES
	ISO Certified	Certification ISO	ISO zertifiziert	Certificato ISO	Certificado ISO
	ISO International safety standards	ISO Normes internationales de sécurité	ISO Internationale Sicherheitsnormen	ISO Norme di sicurezza internazionali	ISO Normas internacionales de seguridad
					
	FSC and recyclable cardboard Certification to promote the appropriate environmental management	FSC et carton recyclable Produit fabriqué avec des matériaux respectant l'environnement, utilisant des matériaux renouvelables de conifères (polymères cellulosiques).	FSC-zertifizierter und recycelbarer Karton Zertifikat zur Förderung des angemessenen Umweltmanagements	FSC e cartone riciclabile Certificazione della corretta gestione ambientale	FSC y cartón reciclable Certificación para promover la apropiada gestión ecológica
	Pharmaceutical waste	Déchets pharmaceutiques	Pharmazeutische Abfall	Rifiuti farmaceutici	Residuos farmacéuticos
	Fruit and vegetable trays	Cageots de fruits et légumes	Obst- und Gemüseverpackungen	Vassoi di frutta e verdura	Bandejas de frutas y verduras
	Fridges and yogurt pots	Réfrigérateurs et pots de yaourt	Kühlschränke und Joghurtbecher	Frigoriferi e contenitori di yogurt	Neveras y envases de yogurt
	Sugar cane	Canne à sucre	Zuckerrohr	Canna da zucchero	Caña de azúcar
	Plastic car parts	Pièces automobiles en plastique	Autoplastikteile	Parti in plastica per autoveicoli	Piezas de plástico de automóvil
	100% renewable electricity The BIC Graphic Europe factory is powered by 100% renewable energy.	100% Électricité d' énergie renouvelable L'usine BIC Graphic Europe s'alimente 100% d'électricité renouvelable.	100% Strom zu 100 % aus erneuerbaren Quellen Die Fabrik von BIC Graphic Europe bezieht ihren Strom zu 100 % aus erneuerbaren Energiequellen.	100 % elettricità da fonti rinnovabili Lo stabilimento BIC Graphic Europe funziona con elettricità proveniente 100% da fonti rinnovabili.	100% electricidad de fuentes renovables La fábrica BIC Graphic Europe se alimenta de energía proveniente de fuentes 100% renovables.
	Imprim'vert Certification for environmentally responsible printing practices.	Imprim'vert Certification pour des pratiques d'impression respectueuses de l'environnement.	Imprim'vert Zertifizierung für umweltfreundliche Druckpraktiken	Imprim'vert Certificazione per pratiche di stampa rispettose dell'ambiente.	Imprim'vert Certificación para prácticas de impresión respetuosas con el medio ambiente.
	Möbius Loop Product contains recycled material.	Möbius Loop Le produit contient des matériaux recyclés.	Möbius Schleife Das Produkt enthält recyceltes Material.	Möbius Loop Il prodotto contiene materiale riciclato.	Möbius Loop El producto contiene material reciclado.
	Refill Service Products are manufactured and printed in European factories where 100% of the electricity used comes from renewable sources.	Service de recharge Les produits sont fabriqués et imprimés dans des usines européennes où 100% de l'électricité utilisée provient de sources renouvelables.	Nachfüllservice Die Produkte werden in europäischen Fabriken gedruckt, in denen 100% des verwendeten Stroms aus erneuerbaren Quellen stammt.	Servizio di ricarica I prodotti sono realizzati e stampati in fabbriche Europee dove il 100% dell'elettricità utilizzata proviene da fonti rinnovabili.	Servicio de recarga Este producto se fabrica e imprime en Europa donde el 100% de la electricidad utilizada proviene de recursos renovables.
	QR code Scan QR code	Code QR Scannez le QR code	QR Code Scannen Sie den QR Code	QR code scannerizza il QR code	QR code Escanea el código QR
	Packaging Information 250 ± 3,5 KG DIMENSIONS: Dimensions published of each product correspond to its maximum size, regardless of the drawing position.	Informations sur l'emballage DIMENSIONS : Les dimensions publiées de tous les produits correspondent à la taille maximale, quelle que soit la position du dessin.	Information zur Verpackung ABMESSUNGEN: Die angegebenen Abmessungen für jedes Produkt entsprechen dessen maximaler Größe. Unabhängig von der Druckposition auf der Abbildung.	Informazioni sul packaging DIMENSIONI: Le dimensioni pubblicate relative a ciascun prodotto corrispondono alla sua dimensione massima indipendentemente dalla posizione del disegno.	Información de envasado DIMENSIONES: Las dimensiones publicadas en cada producto corresponden a su tamaño máximo, independientemente de la posición que muestre el dibujo.
	Regulatory compliance	Respectant les normes	Einhaltung gesetzlicher Bestimmungen	Conformità normativa	Cumplimiento de la normativa

General Information

TECHNICAL PARAMETERS FOR EACH TYPE OF PRINTING

	DIGITAL / DIGITAL TRANSFER	
Minimum positive text	4 pt (1.4 mm)	<small>4 Point text</small>
Minimum negative text	7 pt (2.4 mm)	7 Point text
Minimum text for half tone	1.5 pt (0.5 mm)	7 Point text
Minimum thickness for positive lines	0.25 pt (0.08 mm)	—————
Minimum thickness for negative lines	0.5 pt (0.17 mm)	—————
Minimum thickness for lines in half tone	0.5 pt (0.17 mm)	—————
Minimum half tone values	C: 8% / M: 8% / Y: 12% / K: 8% 	

	britePix™	
Minimum positive text	6 pt (2.1 mm)	<small>6 Point text</small>
Minimum negative text	7 pt (2.4 mm)	7 Point text
Minimum thickness for positive lines	0.4 pt (0.14 mm)	—————
Minimum thickness for negative lines	0.5 pt (0.17 mm)	—————
Minimum thickness for half tones	1 pt (0.35 mm)	—————
Percentage half tone		

	SCREEN PRINTING/ PAD PRINTING	HOT STAMPING / DEBOSSING	LASER ENGRAVING
Minimum positive text	6 pt (2.1 mm) <small>6 Point text</small>	10 pt (3.5 mm) 10 Point text	6 pt (2.1 mm) <small>6 Point text</small>
Minimum negative text	9 pt (3.1 mm) 9 Point text	15 pt (5.25 mm) 15 Point	NOT RECOMENDED
Minimum thickness for positive lines	0.4 pt (0.14 mm) —————	1.5 pt (0.5 mm) —————	0.3 pt (0.1 mm) —————
Minimum thickness for negative lines	0.5 pt (0.176 mm) —————	2 pt (0.706 mm) —————	0.5 pt (0.17 mm) —————
Minimum thickness for half tones	1.5 pt (0.5 mm) —————	NOT POSSIBLE	NOT POSSIBLE
Percentage half tone	50% —————		

Product Index

BIC® WRITING INSTRUMENTS

BIC® Cristal® Expression _____	40
BIC® Cristal® Re'New™ _____	44
BIC® Style _____	48
BIC® Round Stic® _____	52
BIC® Round Stic® BGuard™ antibacterial _____	54
BIC® Round Stic® Ecolutions® _____	55
BIC® M10® Clic _____	58
BIC® Media Clic _____	62
BIC® Media Clic Ecolutions® _____	63
BIC® Media Clic Grip _____	65
BIC® Media Clic Grip Ecolutions® _____	66
BIC® Media Clic BGuard™ antibacterial _____	72
BIC® Media Clic BGuard™ antimicrobial Ecolutions® _____	74
BIC® Media Clic Biobased Ecolutions® _____	76
BIC® Media Clic Biobased BGuard™ antibacterial _____	80
BIC® Media Clic Shine _____	82
BIC® Media Clic Glacé _____	84
BIC® Clic Stic _____	86
BIC® Clic Stic Ecolutions® _____	87
BIC® Clic Stic Stylus _____	90
BIC® Clic Stic Stylus Ecolutions® _____	90
BIC® Super Clip _____	96
BIC® Super Clip Ecolutions® _____	97
BIC® Super Clip Advance _____	100
BIC® Super Clip Glacé _____	104
BIC® Super Clip Glacé Advance _____	104
BIC® Super Clip Soft _____	106
BIC® Super Clip Soft Advance _____	106
BIC® Super Clip Origin _____	108
BIC® Wide Body™ _____	112
BIC® Wide Body™ Ecolutions® _____	113
BIC® 4 Colours® _____	120
BIC® 4 Colours® Rainbow Decor _____	122
BIC® 4 Colours® Bicolor _____	124
BIC® 4 Colours® Gradient _____	126
BIC® 4 Colours® Pastel _____	128
BIC® 4 Colours® Fashion _____	130
BIC® 4 Colours® Sun _____	132
BIC® 4 Colours® Fine _____	134
BIC® 4 Colours® Fluo _____	136
BIC® 4 Colours® Glacé _____	138
BIC® 4 Colours® Shine _____	140
BIC® 4 Colours® Soft _____	142
BIC® 4 Colours® Wood Style _____	144
BIC® 4 Colours® Flags Collection _____	146
BIC® 4 Colours® 3+1 ^{HB} _____	148
BIC® Metal Pro _____	150
BIC® Grip Roller _____	156
BIC® XS Finestyle _____	158

BIC® Intensity® Gel Clic _____	160
BIC® Brite Liner® Grip _____	164
BIC® Velleda® White Board Marker Fine _____	166
BIC® Velleda® White Board Marker Grip _____	167
BIC® Mark-It Permanent Marker _____	168
BIC® Permanent Marker Ecolutions® _____	169
BIC® Matic® _____	172
BIC® Matic® Ecolutions® _____	172
BIC® Media Clic Mechanical pencil _____	174
BIC® Media Clic Grip Mechanical pencil _____	175
BIC® Media Clic Grip Ecolutions® Mechanical pencil _____	175
BIC® Evolution® Ecolutions® _____	180
BIC® Kids Evolution® Colouring Set _____	184
Sprout™ Graphite pencil _____	186

OTHER WRITING INSTRUMENTS

Basic Pen _____	190
Click Pen _____	192
Striped Grip Pen _____	194
Sleek Stylus Pen _____	196

NOTEBOOKS

Rocketbook® Core Executive A5 _____	202
Rocketbook® Fusion Executive A5 _____	204
Rocketbook® Core Mini A6 _____	206

MOLESKINE

Moleskine Classic Notebooks _____	210
Moleskine Cahier Journals _____	214

BIC® LIGHTERS AND CASES

BIC® J25 Lighter _____	222
BIC® J23 Lighter _____	226
BIC® J26 Lighter _____	230
BIC® J38 Lighter _____	234
BIC® Styl'it Luxury Case _____	238
BIC® Aluminium Flat Case _____	240
BIC® Clip Case _____	241
BIC® 3D Case _____	242
BIC® EZ Reach™ _____	244
BIC® Pocket Ashtray _____	248

DJEEP® LIGHTERS

DJEEP® D1 Lighter _____	250
-------------------------	-----

BIC® PACKAGING

BIC® Packaging Ecolutions® _____	262
BIC® Packaging _____	264

Colour table

 01 White	 1E White recycled	 57 Opaque white	 3C White pearl	 01BIO BIO white	 1T White polished	 51 Transparent	 69 Frosted white	 2E Frosted white recycled		
 8D Yellow pastel	 8G Light yellow	 12 Yellow	 12W Yellow wood	 63 Frosted yellow	 6AW Natural wood	 012BIO BIO yellow	 4D Clear yellow	 6F Light brown	 60 Natural	
 9C Inspiring autumn	 26 Gold	 76 Gold glacé	 1G Acid orange	 10 Orange	 90 Orange pastel	 71 Frosted orange	 92 Clear orange			
 03 Red	 03G Red glacé	 03F Red soft	 8E Red recycled	 87 Clear red	 03BIO BIO red	 66 Frosted red	 08 Burgundy			
 14A Peaceful Pink	 14 Pink	 5C Pink fizz	 1P Acid pink	 014G Pink glacé	 07 Gold Pink	 11 Pink	 80 Pink	 97 Rose Gold	 98 Magenta	
 84 Purple pastel	 13 Violet	 39 Frosted Dark Purple	 7G Metallic purple	 2D Purple	 93 Clear Purple	 4B Frosted Purple	 2M Metallic Dark Purple			
 8C Lime	 68 Frosted green	 6C Grass green	 88 Clear light green	 59 Apple green	 82 Frosted dark green	 72 Clear green	 5G Light green	 05G Green glacé	 05 Metallic green	
 05 Green	 05W Green wood	 20 Dark green	 7E Dark green recycled	 88 Clear dark green	 05BIO BIO green	 3B Frosted jungle				
 83 Blue pastel	 4M Cozy blue	 3D Caribbean blue	 86 Clear blue	 67 Frosted blue	 24 Light blue	 04BIO BIO blue	 04 Blue	 04G Blue glacé	 40 Frosted dark blue	 4R Blue turquoise
 34 Metallic Blue	 89 Clear dark blue	 7C Metallic navy blue	 25 Dark blue	 07 Navy blue	 07F Navy blue soft	 10E Navy blue recycled				
 35 Chrome	 47 Silver	 47G Silver glacé	 75 Metallic silver	 18 Metal	 06 Grey	 27 Dark grey	 8H Clear dark grey	 6W Warm Grey		
 02BIO BIO black	 02W Black wood	 02F Black soft	 02 Black	 3E Black recycled	 2N Black matt					

THE BRAND OF RESPONSIBLE BRANDS



www.bicgraphic.com

